

# Economical Three Phase SSR

KMSR Series

## Part Number Description

<b>KMSR</b>	-	<b>1</b>	<b>2</b>	<b>3</b>	<b>4</b>
<b>1 Control Voltage</b>	D : 4 ~ 32VDC	A : 90 ~ 265VAC			
<b>2 Output Type</b>	T : Three phase				
<b>3 Load Current</b>	010 : 10A	020 : 20A	025 : 25A	030 : 30A	040 : 40A
	050 : 50A	060 : 60A	100 : 100A		
<b>4 Load Voltage</b>	2 : 90 ~ 240VAC	4 : 90 ~ 480VAC			

\* Please contact us when using FAN.

## General Specification

### ► General Ratings

<b>Insulation Resistance</b>	100MΩ/ 500VDC(between Terminal and Case)
<b>Dielectric Strength</b>	2500VAC(50/60Hz 1 minute)
<b>Vibration Resistance</b>	10 ~ 55Hz, amplitude : 1.5mm,x,y,z each axis 2 hours
<b>Shock Resistance</b>	1000 m/s <sup>2</sup> ,x,y,z each axis 3times
<b>Storage Temperature</b>	-30°C ~ 90°C (with no icing or condensing)
<b>Ambient Temperature</b>	-25°C ~ 80°C (with no icing or condensing)
<b>Ambient Humidity</b>	45 ~ 85% R.H (no condensing)
<b>Weight</b>	Approx. 530g

Part Number		DT0102	DT0202	DT0252	DT0302	DT0402	DT0502	DT0602	DT1002		
Input Ratings	<b>Rated Control Voltage</b>					4 ~ 32VDC					
	<b>Pick-up Voltage</b>					Min. 3VDC					
	<b>Drop-out Voltage</b>					Max. 1.5VDC					
	<b>Input Current</b>					Max. 25mA					
DC Input AC Output (90 ~ 240VAC)	<b>Rated Load Voltage</b>					90 ~ 240VAC					
	<b>Repetitive Blocking Voltage(Minimum)</b>					600V		800V			
	<b>Rated Load Current</b>	10A	20A	25A	30A	40A	50A	60A	100A		
	<b>Frequency</b>					47 ~ 63Hz					
	Output Ratings	<b>Single cycle Surge Current Resistance</b>	125A	260A			315A	580A			
		<b>Output Leakage Current (Maximum)</b>					10mA				
		<b>Output On Voltage Drop (Maximum)</b>					1.5V				
		<b>Minimum Switching Current</b>					1A				
		<b>Pick-up / Drop-out time</b>					1/2 cycle Max. 1ms				

### \* Heatsink Recommendations

- We recommend that solid state relay modules be mounted to a heatsink sufficient to maintain the module's base temperature at less 85°C under worst case ambient temperature and load conditions.
- The module should be mounted to the heatsink using two#10 screws.

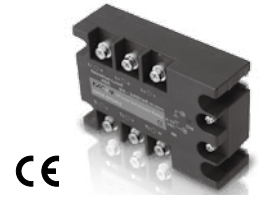

## General Specification

Part Number		DT0104	DT0204	DT0254	DT0304	DT0404	DT0504	DT0604	DT1004	
DC Input AC Output (90 ~ 480VAC)	Rated Control Voltage					4 ~ 32VDC				
	Pick-up Voltage					Min. 3VDC				
	Drop-out Voltage					Max. 1.5VDC				
	Input Current					Max. 25mA				
	Rated Load Voltage					90 ~ 480VAC				
	Repetitive Blocking Voltage(Minimum)	800V					1200V			
	Rated Load Current	10A	20A	25A	30A	40A	50A	60A	100A	
	Frequency					47 ~ 63Hz				
	Single cycle Surge Current Resistance	170A	250A				350A	580A		
	Output Leakage Current (Maximum)					10mA				
	Output On Voltage Drop (Maximum)					1.5V				
	Minimum Switching Current					1A				
	Pick-up / Drop-out time					1/2 cycle Max. 1ms				
	Part Number		AT0102	AT0202	AT0252	AT0302	AT0402	AT0502	AT0602	AT1002
AC Input AC Output (90 ~ 240VAC)	Rated Control Voltage					90 ~ 265VAC				
	Pick-up Voltage					Min. 72VAC				
	Drop-out Voltage					Max. 60VAC				
	Input Current					Max. 15mA				
	Rated Load Voltage					90 ~ 240VAC				
	Repetitive Blocking Voltage(Minimum)				600V			800V		
	Rated Load Current	10A	20A	25A	30A	40A	50A	60A	100A	
	Frequency					47 ~ 63Hz				
	Single cycle Surge Current Resistance	125A	260A				315A	580A		
	Output Leakage Current (Maximum)					10mA				
	Output On Voltage Drop (Maximum)					1.5V				
	Minimum Switching Current					1A				
	Pick-up / Drop-out time					1/2 cycle Max. 1ms				

# Economical Three Phase SSR

KMSR Series

## General Specification

Part Number		AT0104	AT0204	AT0254	AT0304	AT0404	AT0504	AT0604	AT1004
Input Ratings	Rated Control Voltage	90 ~ 265VAC							
	Pick-up Voltage	Min. 72VAC							
	Drop-out Voltage	Max. 60VAC							
	Input Current	Max. 15mA							
AC Input AC Output (90 ~ 480VAC)	Rated Load Voltage	90 ~ 480VAC							
	Repetitive Blocking Voltage(Minimum)	800V	1200V						
	Rated Load Current	10A	20A	25A	30A	40A	50A	60A	100A
	Frequency	47 ~ 63Hz							
	Single cycle Surge Current Resistance	170A	250A	350A	580A				
	Output Leakage Current (Maximum)	10mA							
	Output On Voltage Drop (Maximum)	1.5V							
	Minimum Switching Current	1A							
	Pick-up / Drop-out time	1/2 cycle Max. 1ms							

## Product Selection

Output Voltage Type	Control Voltage	Load Voltage	Load Current	Part Number	Control Voltage	Load Voltage	Load Current	Part Number
 Three phase AC	4 ~ 32VDC	90 ~ 240VAC	10A	KMSR-DT0102	90 ~ 265 VAC	90 ~ 240VAC	10A	KMSR-AT0102
			20A	KMSR-DT0202			20A	KMSR-AT0202
			25A	KMSR-DT0252			25A	KMSR-AT0252
			30A	KMSR-DT0302			30A	KMSR-AT0302
			40A	KMSR-DT0402			40A	KMSR-AT0402
			50A	KMSR-DT0502			50A	KMSR-AT0502
			60A	KMSR-DT0602			60A	KMSR-AT0602
			100A	KMSR-DT1002			100A	KMSR-AT1002
			90 ~ 480VAC	10A			KMSR-DT0104	10A
	20A	KMSR-DT0204		20A	KMSR-AT0204			
	25A	KMSR-DT0254		25A	KMSR-AT0254			
	30A	KMSR-DT0304		30A	KMSR-AT0304			
	40A	KMSR-DT0404		40A	KMSR-AT0404			
	50A	KMSR-DT0504		50A	KMSR-AT0504			
	60A	KMSR-DT0604		60A	KMSR-AT0604			
	100A	KMSR-DT1004		100A	KMSR-AT1004			

## Dimension

unit : mm

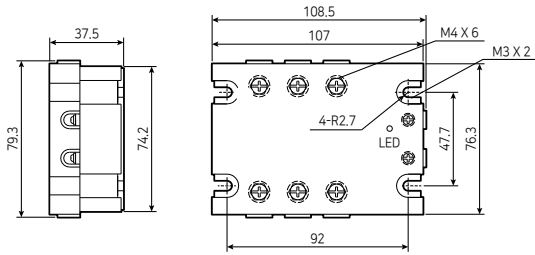

KHS-B025 (10A, 15A, 20A, 25A)

KHS-B040 (30A, 40A)

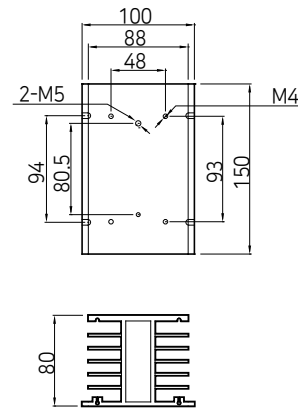
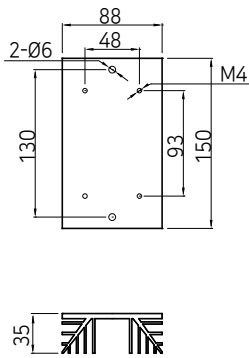

※ Please contact us when using FAN.

## Diagram

Connecting Diagrams

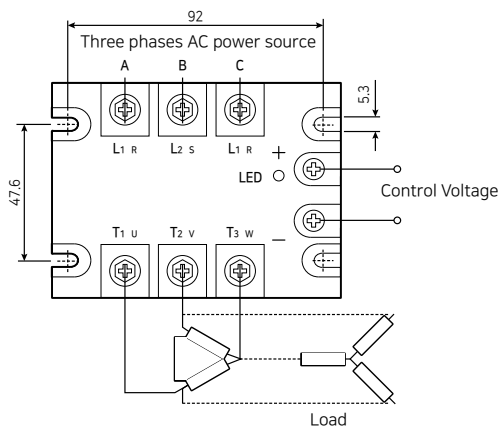

## Terminal

unit : mm

Input

Output

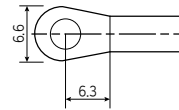
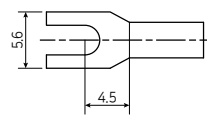

# Economical Three Phase SSR

KMSR Series

## Technical Data

### Input Voltage Vs Current

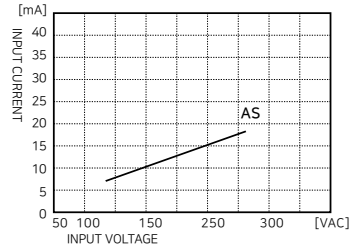
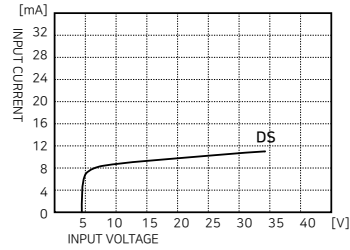

### Maximum Allowable Current vs Ambient Temperature

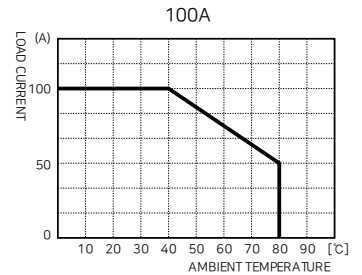
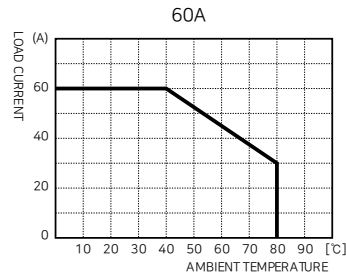
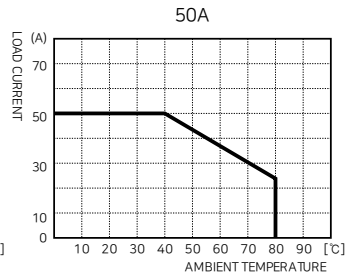
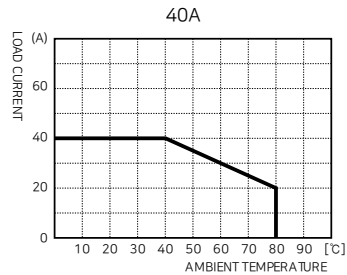
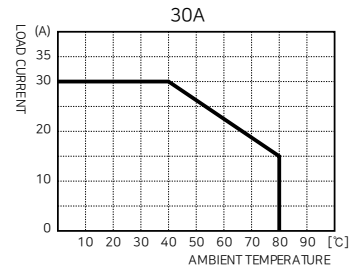
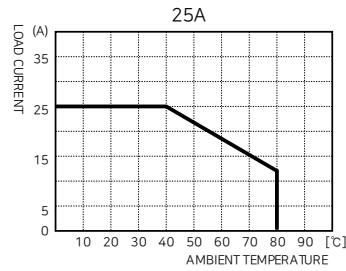
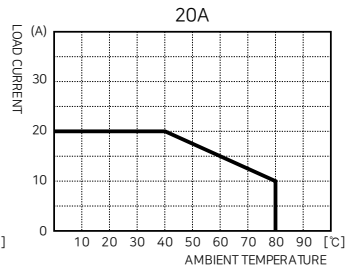
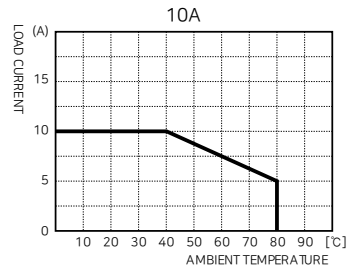

## Mounting

### Panel Mounting Method

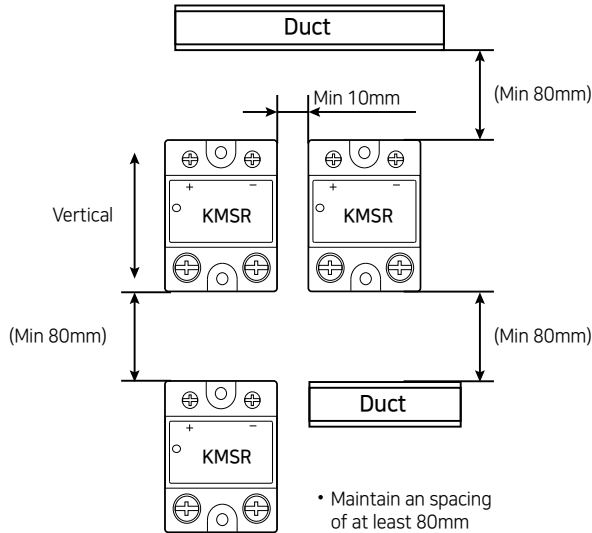

Panel Mounting according to the height of duct.

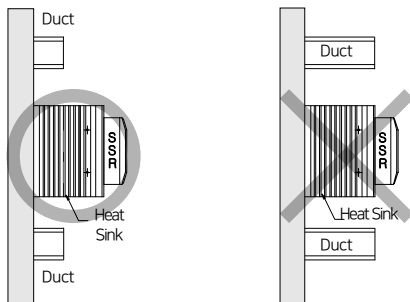

Install ducts lower than Heat Sink.

If the duct is same or higher than heat sink, SSR needs to have a support metal for AIR ventilation.



The heat radiation effect decreases when there is not much room. Limit the load current below the rating. Install the device as far as possible from a heating unit, if there is any. Allow the longest distance possible between the device and other unit.

### Heatsink Installation caution

- If there is no ventilation even when standard heat sink are used, it may cause damage to SSR
- In general, power element of SSR is damaged when the maximum temperature of the 125 °C or higher. Since the power element temperature is close to 125 °C when the temperature of the surface of heat sink is 80 °C or higher, check the temperature of heat sink too during operation
- Remove the foreign material from the mounting surface of the heatsink, and apply silicon grease to the surface.
- The heat radiation effect greatly depends on the mounting condition and silicon grease application.
- Tighten the fixing bolts at the specified torque for fixing the device to the radiator

# Economical Three Phase SSR

## KMSR Series

### Caution

< How to control the temperature of KMSR in a panel >

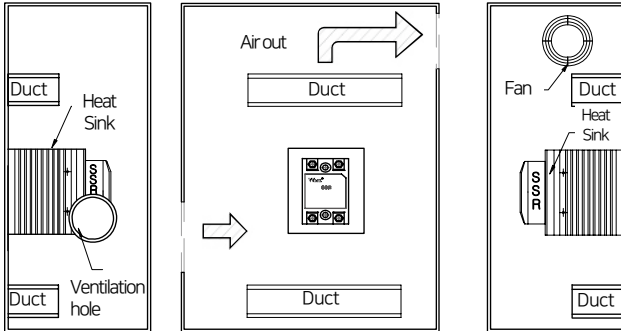

- If filters are installed in a ventilation hole, it needs to have a regular cleaning for proper ventilation.
- The rated current is the value calculated at SSR's ambient temperature of 40°C
- Direct the fan in the lower direction for vertical installation, and in the air inlet direction for horizontal direction.
- If the horizontally mounted device does not have an integrated fan, use it at 50% of the rated current or less.
- Pay attention to the increase in the ambient temperature from the heating of the device. Especially when mounting the device in the panel, be sure to install a fan for sufficient ventilation.
- Remove any obstacles for air flow around the air inlet and outlet.