



Online Data Sheet

Encoder WDG 100I

www.wachendorff-automation.com/wdg100i

Wachendorff Automation

... systems and encoders

- Complete systems
- Industrial rugged encoders to suit your application
- Standard range and customer versions
- Maximum permissible loads
- 48-hour express production
- Made in Germany
- Worldwide distributor network

Encoder WDG 100I

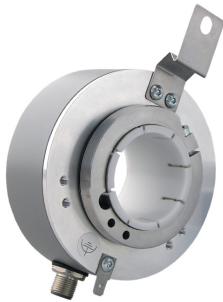

- Rugged and extremely thin thru-bore encoder for extension on power motors
- Thru-Bore, bore size max. 42 mm
- Balanced stainless steel clamping ring for smooth running
- Insulating sleeve to protect the bearings from currents
- Full connection protection with 10 VDC up to 30 VDC
- Easy mounting
- Meets protection class IP54
- Up to 20,480 PPR
- Optional: -40 °C up to +80 °C
Protection to IP55 all around

www.wachendorff-automation.com/wdg100i

Resolution	
Pulses per revolution PPR	up to 20480 PPR

Mechanical Data	
Housing	
Flange	hollow shaft (through-bored)
Flange material	aluminum
Housing cap	aluminum, powder coated
Torque supports	incl. 1 torque support WDGDS10012
- 1. Spring plate compensation	axial: ±0.8 mm, radial: ±0.2 mm
Housing	Ø 100 mm

Shaft(s)	
Shaft material	stainless steel, (insulation sleeve: POM-C)
Starting torque	approx. 1.5 Ncm at ambient temperature
Fixing	clamping screw M4 with hexagon socket

Shaft	Ø 25 mm
Advice	with insulating sleeve
Shaft length	L: 48.8 mm
Max. Permissible shaft loading radial	200 N
Max. Permissible shaft loading axial	100 N

Shaft	Ø 30 mm
Advice	with insulating sleeve
Shaft length	L: 48.8 mm
Max. Permissible shaft loading radial	200 N
Max. Permissible shaft loading axial	100 N

Shaft	Ø 32 mm
Advice	with insulating sleeve
Shaft length	L: 48.8 mm
Max. Permissible shaft loading radial	200 N
Max. Permissible shaft loading axial	100 N

Shaft	Ø 38 mm
Advice	with insulating sleeve

Shaft length	L: 48.8 mm
Max. Permissible shaft loading radial	200 N
Max. Permissible shaft loading axial	100 N

Shaft	Ø 40 mm
Advice	with insulating sleeve
Shaft length	L: 48.8 mm
Max. Permissible shaft loading radial	200 N
Max. Permissible shaft loading axial	100 N

Shaft	Ø 42 mm
Advice	with insulating sleeve
Shaft length	L: 48.8 mm
Max. Permissible shaft loading radial	200 N
Max. Permissible shaft loading axial	100 N

Bearings	
Bearings type	2 precision ball bearings
Nominale service life	3 x 10 ¹⁰ revs. at 100 % rated shaft load 1 x 10 ¹¹ revs. at 40 % rated shaft load 1 x 10 ¹² revs. at 20 % rated shaft load
Max. operating speed	3500 rpm

Machinery Directive: basic data safety integrity level	
MTTF _d	200 a
Mission time (TM)	25 a
Nominale service life (L10h)	1 x 10 ¹² revs. at 20 % rated shaft load and 3500 rpm
Diagnostic coverage (DC)	0 %

Electrical Data	
Power supply/Current consumption	4,75 VDC up to 5,5 VDC: typ. 100 mA
Power supply/Current consumption	5 VDC up to 30 VDC: typ. 70 mA
Power supply/Current consumption	10 VDC up to 30 VDC: typ. 100 mA

Output circuit	TTL TTL, RS422 compatible, inv. HTL HTL, inv. 1 Vpp sin/cos
Pulse frequency	TTL 5000 ppr: max. 200 kHz HTL 5000 ppr: max. 200 kHz TTL more than 1200 ppr: max. 2 MHz HTL more than 1200 ppr: max. 600 kHz 1 Vpp sin/cos: max. 100 kHz
Channels	AB ABN and inverted signals
Load	max. 40 mA / channel @ 1 Vpp sin/cos: min. 120 Ohm
Circuit protection	circuit type H24 and R24 only
Electric strength (DIN EN 60243-2)	Insulating sleeve: 500 V

Accuracy

Phase offset	90° ± max. 7.5 % of the period duration
pulse-/pause-ratio	5000 ppr: 50 % ± max. 7 % Output circuits F24, P24, F05, P05, 645: 50 % ± max. 10 %

General Data

Weight	approx. 900 g
Connections	cable or connector, radial
Protection rating (EN 60529)	IP54
Operating temperature	-20 °C up to +80 °C 1 Vpp: -10 °C up to +70 °C
Storage temperature	-30 °C up to +80 °C

More Information

General technical data and safety instructions
<http://www.wachendorff-automation.com/gtd>

Options
<http://www.wachendorff-automation.com/acc>

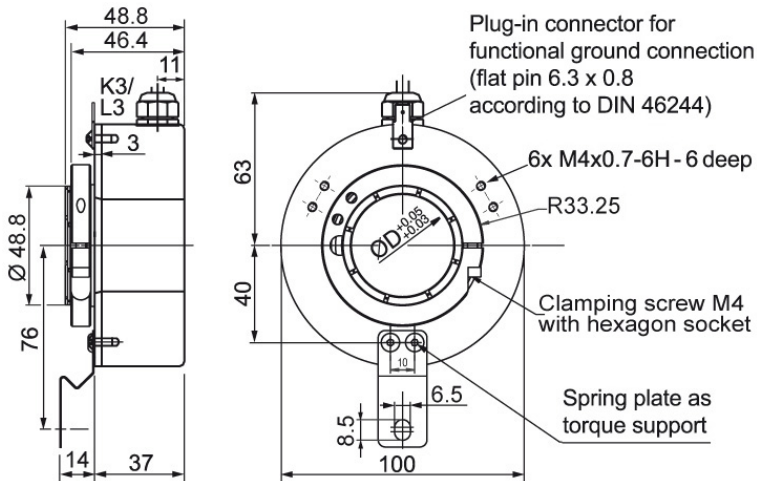
Cable connection K3, L3 with 2 m cable

Description
K3 radial, shield not connected

L3 radial, shield connected to encoder housing

ABN inv. poss.

•

•



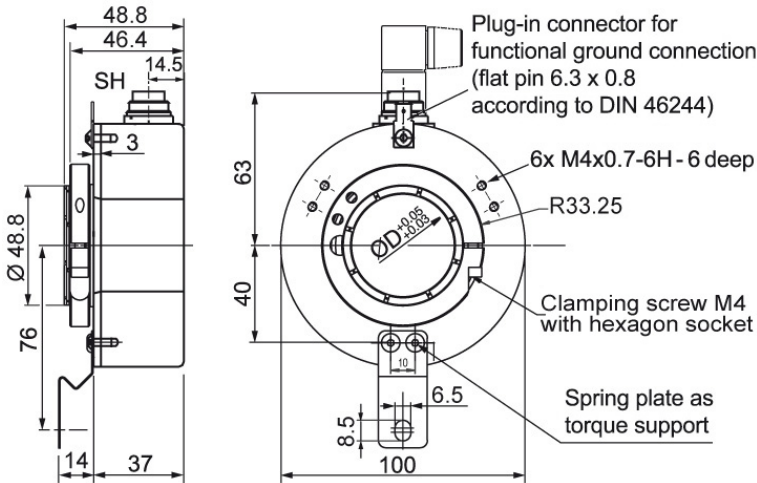

Assignments

	K3, L3	K3, L3	L3	L3
Circuit	F05, H05, F24, H24, H30	P05, R05, P24, R24, 245, 645, R30	SIN	SIF
GND	WH	WH	WH	WH
(+) Vcc	BN	BN	BN	BN
A	GN	GN	GN	GN
B	YE	YE	GY	GY
N	GY	GY	BK	BK
Light reserve warning	-	-	-	RD
A inv.	-	RD	YE	YE
B inv.	-	BK, (BU at ACA)	PK	PK
N inv.	-	VT	VT	VT
Shield	flex	flex	flex	flex

Connector (M16x0.75) SH, 5-, 6-, 8-, 12-pin

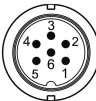

Description	ABN inv. poss.
SH5 radial, 5-pin, Connector connected to encoder housing	-
SH6 radial, 6-pin, Connector connected to encoder housing	-
SH8 radial, 8-pin, Connector connected to encoder housing	•
SH12 radial, 12-pin, Connector connected to encoder housing	•

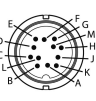
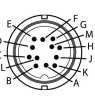
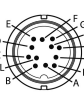
Assignments	SH5	SH6	SH8	SH8	SH8	SH12	SH12	SH12
	5-pin	6-pin	8-pin	8-pin	8-pin	12-pin	12-pin	12-pin
								
Circuit	F05, H05, F24, H24, H30	F05, H05, F24, H24, H30	F05, H05, F24, H24, H30	P05, R05, P24, R24, R30, 245, 645	SIN	P05, R05, P24, R24, 245, 645, R30	F05, H05, F24, H24, H30	SIN
GND	1	6	1	1	1	K, L	K, L	K, L
(+) Vcc	2	1	2	2	2	M, B	M, B	M, B
A	3	2	3	3	3	E	E	E
B	4	4	4	4	4	H	H	H
N	5	3	5	5	5	C	C	C
Light reserve warning	-	-	-	-	-	-	-	-
A inv.	-	-	-	6	6	F	-	F
B inv.	-	-	-	7	7	A	-	A
N inv.	-	-	-	8	8	D	-	D
n. c.	-	5	6, 7, 8	-	-	G, J	A, D, F, G, J	G, J
Shield	-	-	-	-	-	-	-	-

Connector (M16x0.75) S3, 7-pin

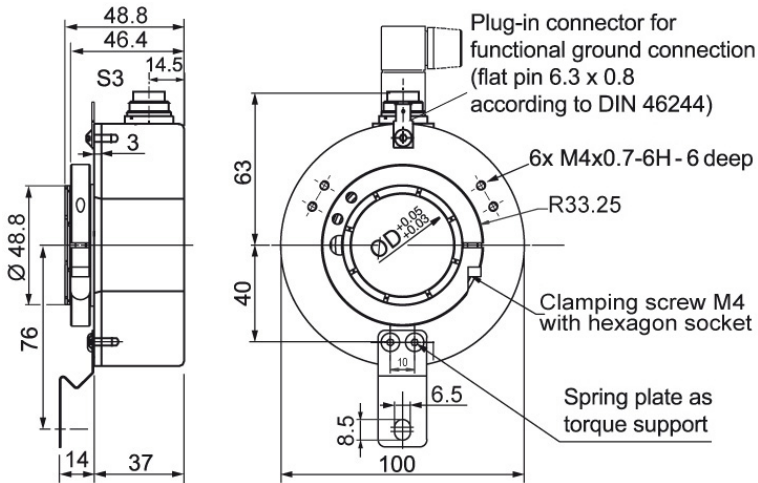

Description

ABN inv. poss.

S3 radial, 7-pin, Connector connected to encoder housing

-

Assignments	
	S3
	7-pin
	
Circuit	F05, H05, F24, H24, H30
GND	1
(+) Vcc	2
A	3
B	4
N	5
Light reserve warning	-
A inv.	-
B inv.	-
N inv.	-
n. c.	6, 7
Shield	-

Connector (M23) S5, 12-pin

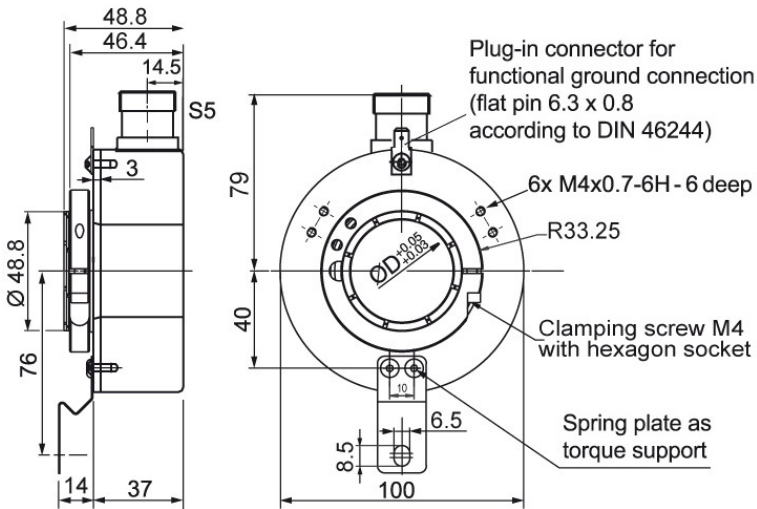

Description

ABN inv. poss.

S5 radial, 12-pin, Connector connected to encoder housing

•

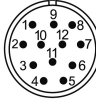
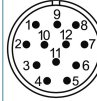
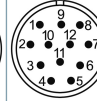
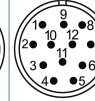
Assignments				
	S5	S5	S5	S5
	12-pin	12-pin	12-pin	12-pin
				
Circuit	F05, H05, F24, H24, H30	P05, R05, P24, R24, 245, 645, R30	SIN	SIF
GND	10	10	10	10
(+) Vcc	12	12	12	12
A	5	5	5	5
B	8	8	8	8
N	3	3	3	3
Light reserve warning	-	-	-	7
A inv.	-	6	6	6
B inv.	-	1	1	1
N inv.	-	4	4	4
n. c.	1, 2, 4, 6, 7, 9, 11	2, 7, 9, 11	2, 7, 9, 11	2, 9, 11
Shield	-	-	-	-

Connector (M23) S5R, 12-pin (clockwise)

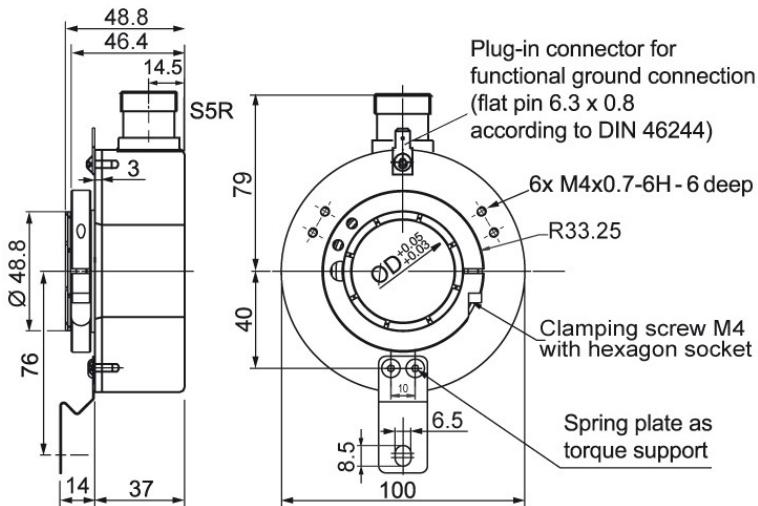

Description

ABN inv. poss.

S5R radial, 12-pin, Connector connected to encoder housing

•

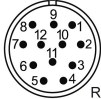
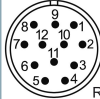
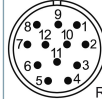
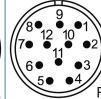
Assignments				
	S5R	S5R	S5R	S5R
	12-pin	12-pin	12-pin	12-pin
				
Circuit	F05, H05, F24, H24, H30	P05, R05, P24, R24, 245, 645, R30	SIN	SIF
GND	10	10	10	10
(+) Vcc	12	12	12	12
A	5	5	5	5
B	8	8	8	8
N	3	3	3	3
Light reserve warning	-	-	-	7
A inv.	-	6	6	6
B inv.	-	1	1	1
N inv.	-	4	4	4
n. c.	1, 2, 4, 6, 7, 9, 11	2, 7, 9, 11	2, 7, 9, 11	2, 9, 11
Shield	-	-	-	-



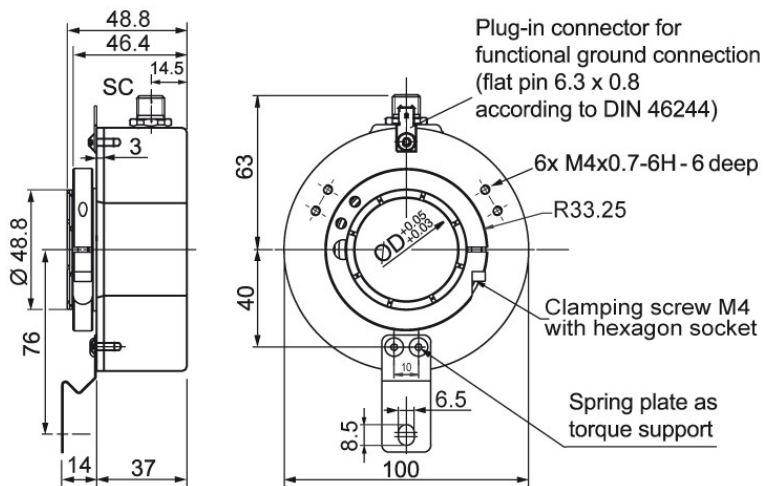

Sensor-connector (M12x1) SC, 4-, 5-, 8-pin



Description

ABN inv. poss.

SC4	radial, 4-pin, Connector connected to encoder housing	-
SC5	radial, 5-pin, Connector connected to encoder housing	-
SC8	radial, 8-pin, Connector connected to encoder housing	•

Assignments					
	SC4	SC5	SC8	SC8	SC8
	4-pin	5-pin	8-pin	8-pin	8-pin
					
Circuit	F05, H05, F24, H24, H30	F05, H05, F24, H24, H30	F05, H05, F24, H24, H30	P05, R05, P24, R24, R30, 245, 645	SIN
GND	3	3	1	1	1
(+) Vcc	1	1	2	2	2
A	2	4	3	3	3
B	4	2	4	4	5
N	-	5	5	5	7
Light reserve warning	-	-	-	-	-
A inv.	-	-	-	6	4
B inv.	-	-	-	7	6
N inv.	-	-	-	8	8
n. c.	-	-	6, 7, 8	-	-
Shield	-	-	-	-	-

Options

Low temperature

The encoder WDG 100I with the output circuit types F24, H24, P24, R24, F05, H05, P05, R05, 245, 645 is also available with the extended temperature range -40 °C up to +80 °C (measured at the flange).

Order key

ACA

IP55 all around (not 1 Vpp Sin/Cos)

The encoder WDG 100I can be supplied in a full IP55 version.

Order key

ACP

Max. RPM: 1500 rpm

Permitted Shaft-Loading, axial: 100 N, 12.237 kp

Permitted Shaft-Loading, radial: 120 N, 22.434 kp

Max. PPR: 5000 ppr

Starting-torque: approx. 5 Ncm at ambient temperature, approx. 1.416 in-ozf at ambient temperature

Cable length

The encoder WDG 100I can be supplied with more than 2 m cable. The maximum cable length depends on the supply voltage and the frequency; see www.wachendorff-automation.com/atd

Please extend the standard order code with a three figure number, specifying the cable length in decimetres.

Example: 5 m cable = 050

Order key

XXX = Decimeter

Example Order No.	Type				Your encoder
WDG 100I	WDG 100I				WDG 100I
Bore size					
38	25; 30; 32; 38; 40; 42				
Pulses per revolution PPR:					
1024	512, 1024, 2048, 2500, 3600, 4096, 4500, 5000, 8192, 10240, 16384, 20480 1 Vpp Sin/Cos only 1024, 2048 Other PPRs on request				
Channels:					
ABN	AB, ABN				
Output circuit					
H24	Resolution PPR	Power supply VDC	Output circuit	Light reserve warning	Order key
	up to 2500	5 - 30	HTL	-	H30
		5 - 30	HTL inverted	-	R30
	up to 5000	4.75 - 5.5	TTL	-	H05
		4.75 - 5.5	TTL, RS422 comp., inverted	-	R05
		10 - 30	HTL	-	H24
		10 - 30	HTL inverted	-	R24
	8192 up to 20480	10 - 30	TTL, RS422 comp., inverted	-	245
		4.75 - 5.5	TTL	-	F05
		4.75 - 5.5	TTL, RS422 comp., inverted	-	P05
		10 - 30	HTL	-	F24
	1024, 2048	10 - 30	HTL inverted	-	P24
		10 - 30	TTL, RS422 comp., inverted	-	645
		4.75 - 5.5	1 Vpp sin/cos	•	SIF
	4.75 - 5.5	1 Vpp sin/cos	-	SIN	
Electrical connections					
K3	Description			ABN inv. poss.	Order key
	Cable: length (2 m standard, WDG 58T: 1 m)				
	radial, shield not connected			•	K3
	radial, shield connected to encoder housing			•	L3
	Connector: (shield connected to encoder housing)				
	connector, M16x0.75, 5-pin, radial			-	SH5
	connector, M16x0.75, 6-pin, radial			-	SH6
	connector, M16x0.75, 8-pin, radial			•	SH8
	connector, M16x0.75, 12-pin, radial			•	SH12
	connector, M16x0.75, 7-pin, radial			-	S3
	connector, M23, 12-pin, radial			•	S5
	connector, clockwise pin count, M23, 12-pin, radial			•	S5R
	sensor-connector, M12x1, 4-pin, radial			-	SC4
	sensor-connector, M12x1, 5-pin, radial			-	SC5
sensor-connector, M12x1, 8-pin, radial			•	SC8	
Options					
Description			Order key		
Low temperature			ACA		
IP55			ACP		
Without option			Empty		
Cable length			XXX = Decimeter		

Example Order No.=	WDG 100I	38	1024	ABN	H24	K3		WDG 100I						Your encoder
---------------------------	----------	----	------	-----	-----	----	--	----------	--	--	--	--	--	---------------------



For further information please contact our local distributor.
Here you find a list of our distributors worldwide.
<https://www.wachendorff-automation.com/>



Wachendorff Automation GmbH & Co. KG
Industriestrasse 7 • 65366 Geisenheim
Germany

Phone: +49 67 22 / 99 65 25
Fax: +49 67 22 / 99 65 70
E-Mail: wdg@wachendorff.de
www.wachendorff-automation.de

