

## FNC HW 100 Series



### Features

- **Axis selection switch**
- **Rate override switch**
- **Reset switch**
- **100 ppr standard encoder**
- **Voltage output**
- **5-30V wide supply range**
- **Line driver output**

### Pulse diagram

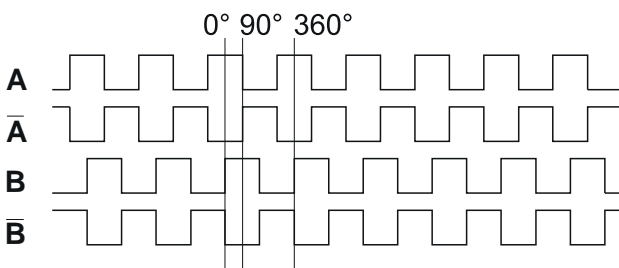

### Technical data - electrical ratings

Operating voltage	+5V .. 30V (Hand wheel)
Output type	RS422 (Hand wheel)
Output signals	90° shifted A and B, inverted
Frequency response	0 - 5 kHz
Current consumption	max 60mA
Utilization category	250 VAC /3A (Emergency stop)
Switching capacity (VA)	max. 0,2VA
Switching voltage	max. DC 50V push buttons max. 15V selector switch max. AC32V push buttons

### Technical data - mechanical ratings

Encoder material	Shaft: Stainless steel Housing : Aluminum Cover : ABS
Hand wheel material	Housing : ABS
Normal rotational speed	max 200 r / min
Operating temperature	-10...+80°C
Weight approx.	450 g

### Mechanical Dimensions

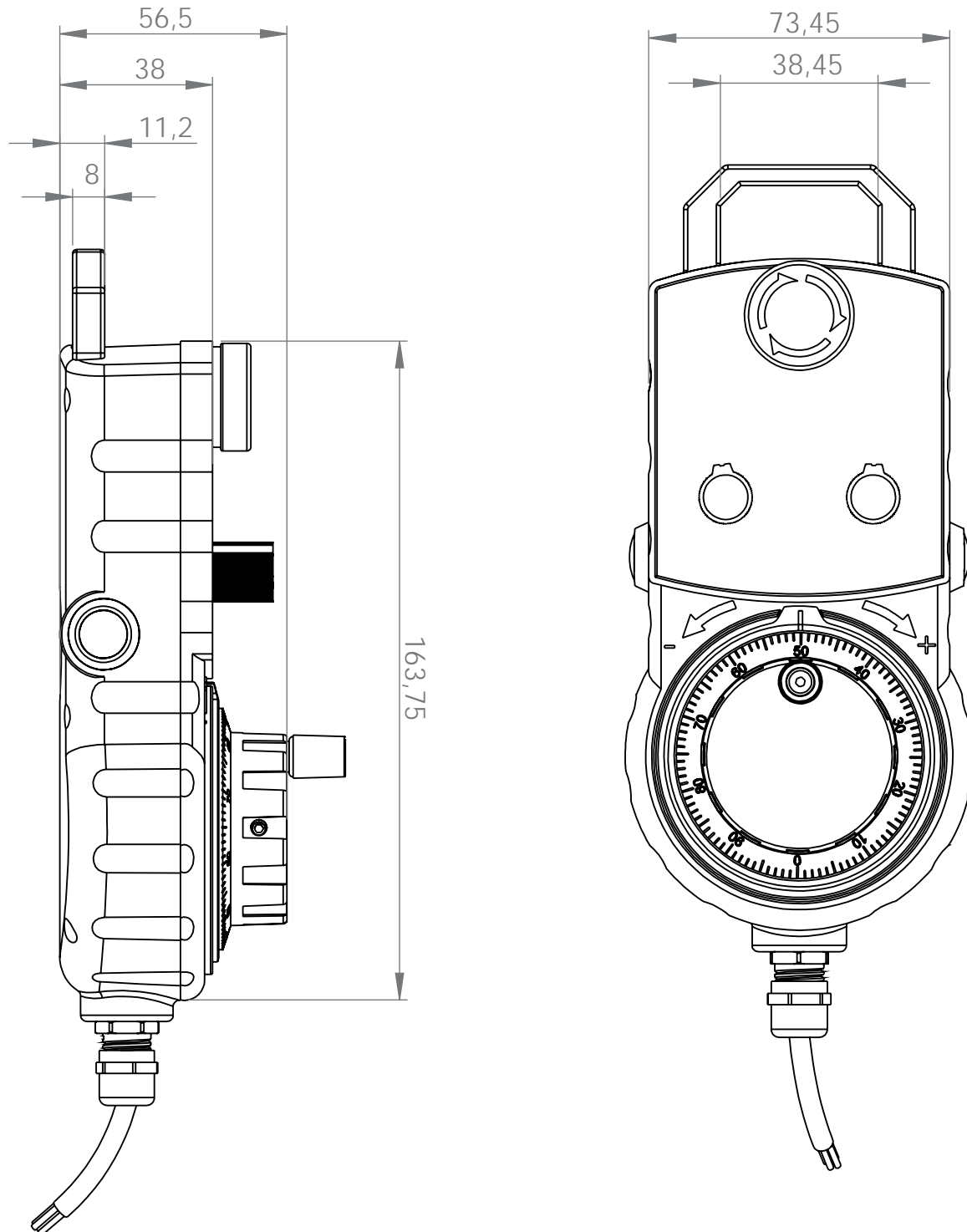

## FNC HW 100 Series

### Mechanical Dimensions

**EMERGENCY STOP**



**HANGER**



**AXIS SELECTION SWITCH**

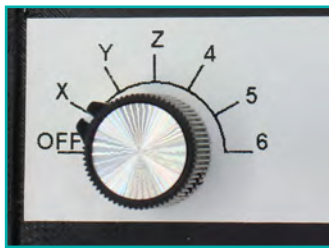

**RATE OVERRIDE SWITCH**

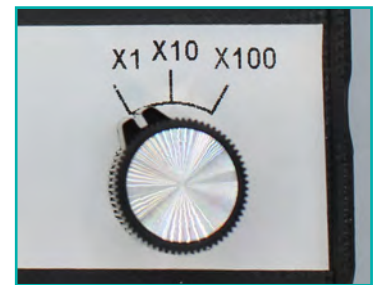







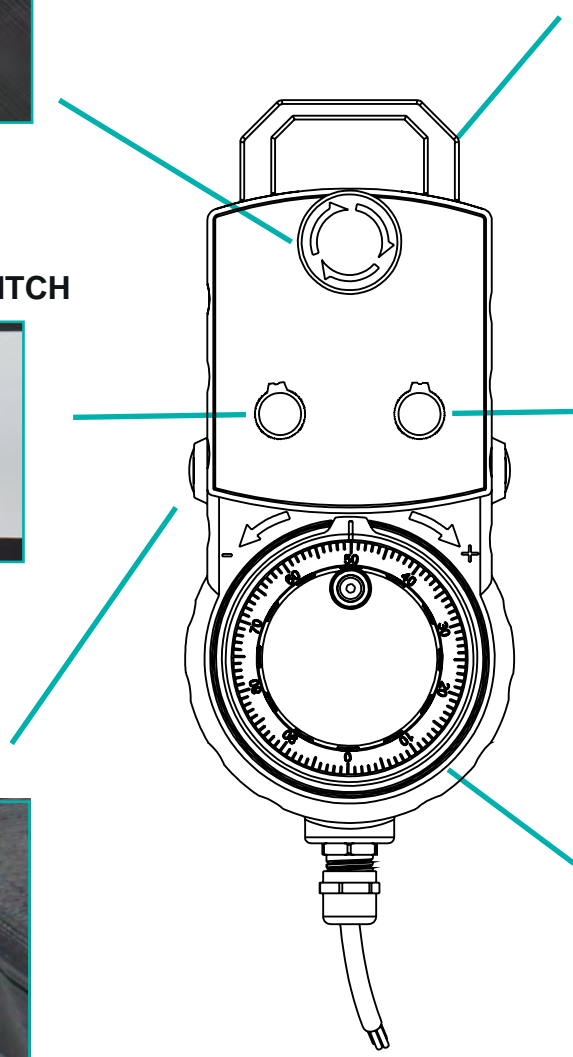





**SAFETY SWITCH**



**100 PPR ENCODER**



#### Cable Connection

Function	Color	Renk	
+VCC		Red	Kırmızı
GND		Black	Siyah
A		Green-Black	Yeşil-Siyah
A'		Green-White	Yeşil-Beyaz
B		Yellow	Sarı
B'		Yellow-Black	Sarı-Siyah
X1		Gray	Gri
X10		Pink	Pembe
X100		Purple	Mor
COM		White	Beyaz
X		Brown	Kahverengi
Y		Brown-Green	Kahverengi-Yeşil
Z		Blue-Black	Mavi-Siyah
4		Red-Black	Kırmızı-Siyah
EM1		Red-Blue	Kırmızı-Mavi
EM2		Black-White	Siyah-Beyaz

