



1 Safety Precautions

Be sure to read cautions before use for correct use.

- ※ The specifications and exterior sizes described in this manual may be subject to change for improving product capacity.
- ⚠ Safety Precautions**
 - This product was not manufactured as a safety device. Therefore, in case of using it as a controller such as for a device that may cause casualty, serious damage to peripheral devices, and tremendous loss of property, be sure to attach double safety devices.
 - Do not wire or inspect or repair while power is on.
 - In case of supplying power, be sure to check a terminal number for connection.
 - This device should not be disassembled, processed, improved, or repaired.

⚠ Caution

- Before the installation of this device, understand fully how to use, safety regulations or warnings, and be sure to use within specified related specifications or related capacities.
- Do not wire or install it for a motor or solenoid with great inductive load.
- During the extension of a sensor, use a shielding wire, and do not make it unnecessarily longer.
- Do not use the same power supply or any part that generates arc during closing or opening directly near the power supply.
- A power line should be far apart from a high-tension wire, and the device should not be installed in a place containing much water, oil, or dust.
- Do not install it in a place with strong magnetism or noise or vibration or impact.
- Put it far apart from a place that may release strongly alkaline or strongly acidic substance, and use an independent pipe.
- Do not spray water directly on it for cleaning in case of installing it in the kitchen.
- Do not install it in a place where temperature/humidity exceeds rating.
- Take caution not to break a sensor wire or make any scratch.
- A sensor wire should be away from a signal line, power, and load line, and use an independent pipe.
- In case of dissembling or modifying this product voluntarily, it may not be applied with warranty service.
- A **⚠** mark on the terminal circuit diagram is a safety mark as warning or caution.
- Do not use it near any device (harmonics welder, harmonics, harmonics radio, and large capacity SCR controller) that generates strong harmonics noise.
- In case of using it with any other method than one designated by a manufacturer, injury or loss of properties may occur.
- As it is not a toy, keep out of the reach of children.
- Installation must be done by a relevant professional or a qualified person.
- Our company shall not be responsible for any damage caused by failing to observe the contents specified in the above warnings or cautions or by the fault of a consumer.

⚠ Danger

- **Caution, risk of electric shock**
 - Electric Shock - Do not contact with AC terminal during current carrying. This may cause electric shock.
 - Input power must be blocked when checking input power.

2 Models

Model	Sensor	Range	Dimension	Function
FOX-300JSHR	SHT11	-29 ~ 99.9°C 0.0 ~ 99.9%	W194 x H241mm	Temp./Humi. control RS485
FOX-300-2S	SH-104	-29.9 ~ 99.9°C 0 ~ 100%	W72 x H72mm	Temp./Humi. control RS485
FOX-300A-1			W72 x H72mm	
FOX-300AR1	HCPV-220NH	-40.0 ~ 65.0°C 10 ~ 95%	W194 x H241mm	Temp./Humi. control RS485
FOX-300JR1				
FOX-8300R1			W94 x H150mm	

※ FOX-300 series model

The sensor HCPV-220NH (Temp./Humi) is replaceable with

Temp. : FS-200N(NTC-10K)
Humi. : HCPV-220

Temp. & Humi. ranges are also available upto
-55.0°C ~ 99.9°C
10 ~ 95%

3 Name of each parts

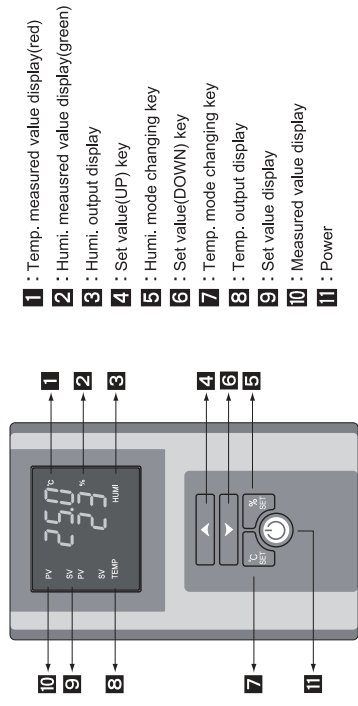

- Temp. measured value display (red)
- Humi. measured value display (green)
- Humi. output display
- Set value (UP) key
- Humi. mode changing key
- Set value (DOWN) key
- Temp. mode changing key
- Temp. output display
- Set value display
- Measured value display
- Power

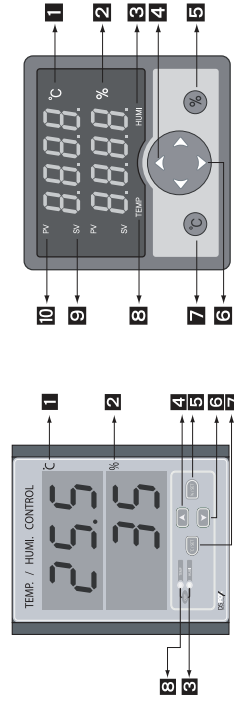

4 Wiring terminal

Output : 250VAC 2A
Please make sure to use the power relay or a suitable magnet.

▲ FOX-300AR1, FOX-300-2S

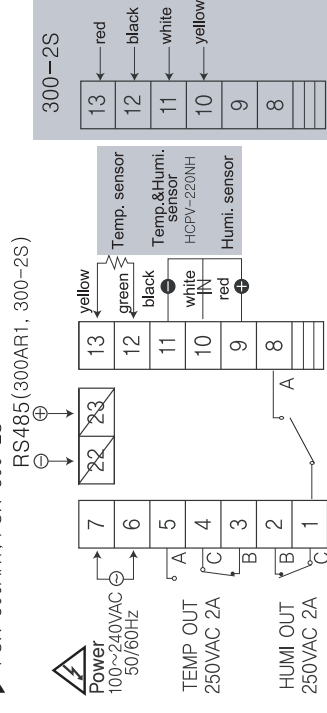

▲ FOX-300JR1



▲ FOX-300JSHR



▲ FOX-8300R1

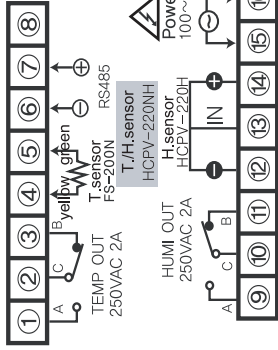

5 Product exterior dimension

▲ FOX-300AR1, FOX-300-2S(72x72x110mm)

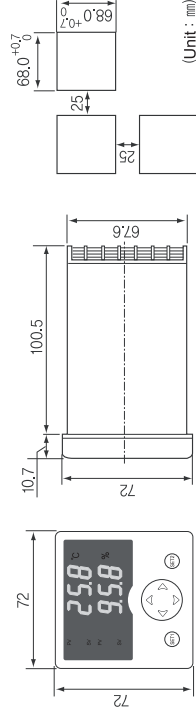

▲ FOX-300JR1(194x241x60mm)

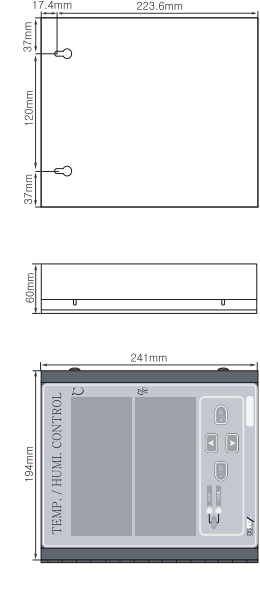

▲ FOX-8300R1(94x150x39mm)

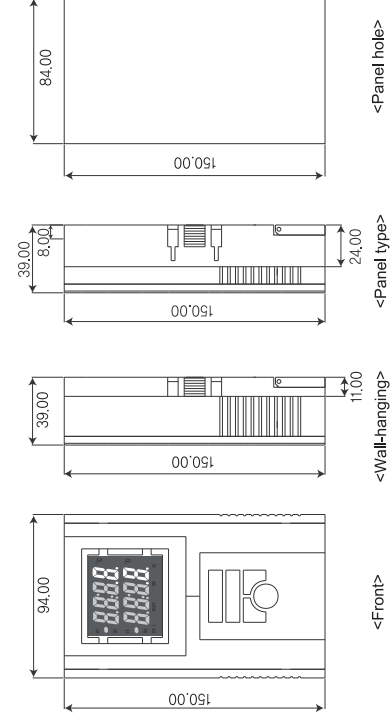

6 Temperature

Setting for temperature

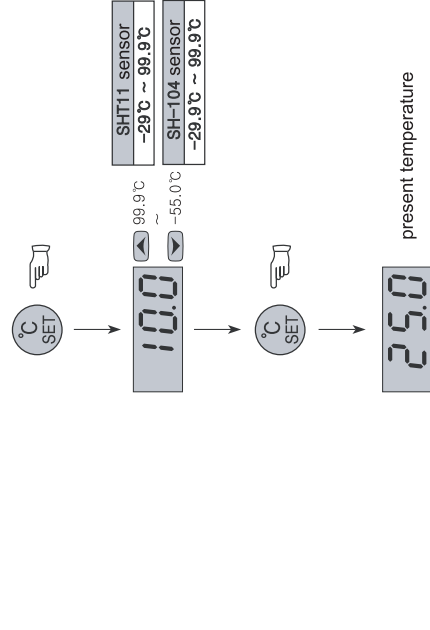

Setting for temperature programs

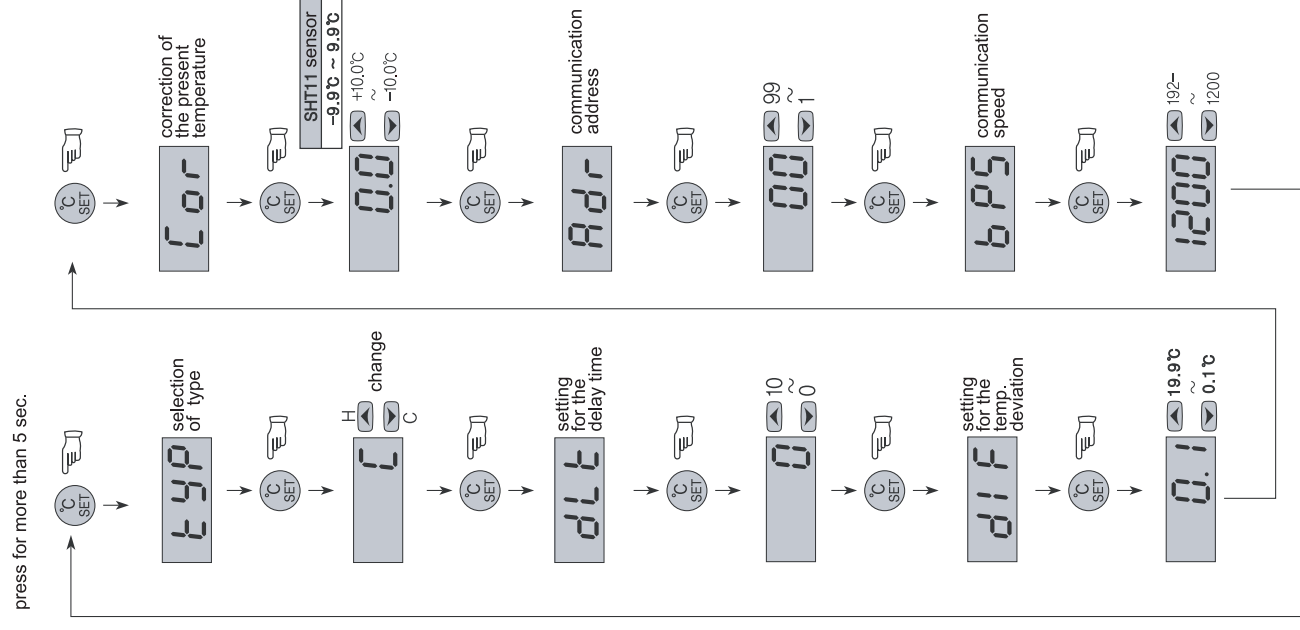

press for more than 5 sec.

7 Humidity

Setting for the humidity

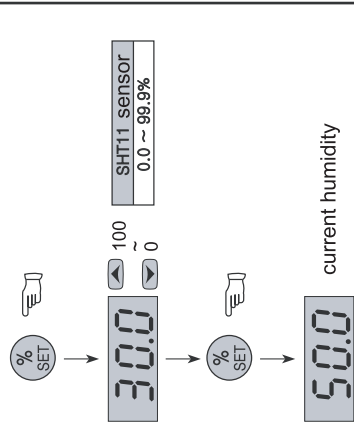

Setting for the humidity program

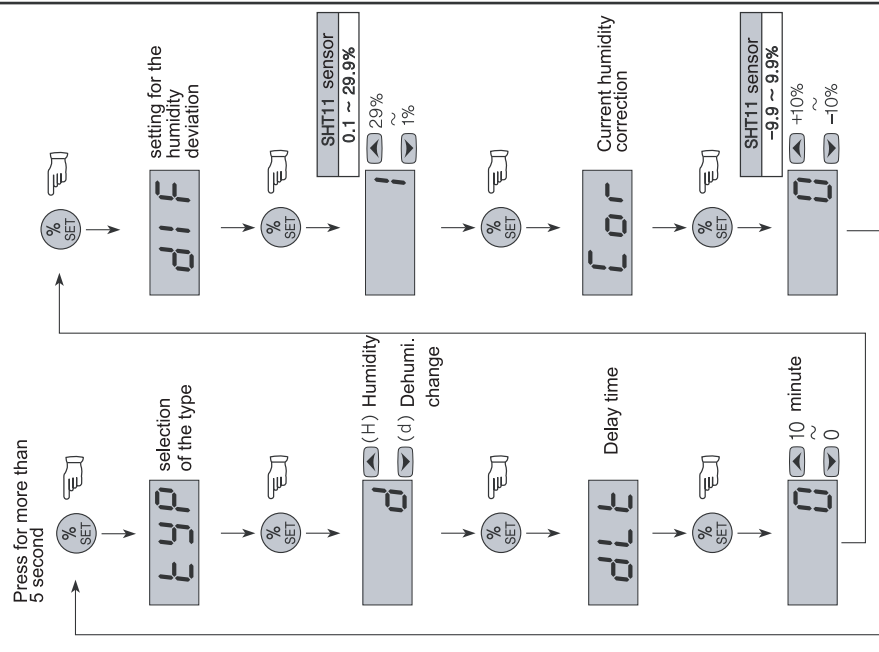

* Pressing SET key for 5 sec. in the state of current temperature display, can be entered the program setting mode.
 * All programs are returned automatically in 30 sec. to the present temperature after displaying **Er-1** by pressing SET key once after set value changing.

8 About Detailed Function

- d i F** : Temperature : Select Cooling(C) or Heating(H)
 Humidity : Select Dehumidity(d) or Humidity(H)
- d l t** : Deviation temperature setting
 - A regular interval is required between ON and OFF in the ON/OFF control (set up ON/OFF width)
 - Frequent ON and OFF will shorten the lifespan of the relay or the output contact or cause hunting (generation, chattering) by noise from outside. The temperature deviation function is used to setup temperature deviation to protect the equipment contact, etc.

Γ Method of temperature deviation when ON/OFF control.]

For Cooling/Dehumidifying

• PV > SV + DV
 → output **on**
 • PV ≤ SV
 → output **off**

For Heating/Humidifying
 • PV < SV - DV
 → output **on**
 • PV ≥ SV
 → output **off**

3. d l t : Output Delay Time

- This function should be used when an object subject to control repeats ON/OFF actions and cause problems (chillers, compressors).
 - A function to protect the working machine upon momentary power failure or power is reapplied.

Ex)

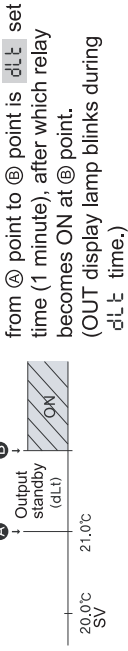

4. Cor : Current temperature calibration function

- While there is no problem in the product, a function to calibrate when temperature is different error and reference standard that occur in the input sensor (e.g. Mercury thermometer or a thermometer currently use, a temperature controller)

e.g.) Actual temperature : 10.0°C → [Cor] : 0.0 ⇒ -2.0
 Display Window : 12.0°C

Display in → 10.0°C (corrected current temperature)

5. R d r : Communication station settings

- When using the RS485 communication, specify a station number between 1-99.

6. b P 5 : Communication speed settings

- 120 : 1200 : 1200bps
 - 240 : 2400 : 2400bps
 - 480 : 4800 : 4800bps
 - 960 : 9600 : 9600bps
 - 192 : 1920 : 19200bps
- (Start bit 1, Stop bit 1, Non parity)

10 Setting range and default set

Set humidity	Function	Display	Range	Default	Remarks
	Humidity setting (HCPV-220H)		0 ~ 100%	30	SHT11 : 0.0 ~ 99.9
	Selection of function	d i F	d / H	d	d : For dehumidifying H : For humidifying
	Humidity deviation (HCPV-220H, SH-104)	d i F	1 ~ 29	1	SHT11 : 0.1 ~ 29.9
	Output delay time	d l t	0 ~ 10	0	Minute
	Correction of the humidity (HCPV-220H, SH-104)	Cor	-10 ~ 10	0	correct discrepancy between the value in displayed and actual value SHT11 : -9.9 ~ 9.9

11 Communication

Interface

Specification	In conformity EIA RS485
Maximum connection lines	32 units (However, Address setting is available from 01 to 99)
Method	2-wire half-duplex
Synchronous system	Asynchronous
Distance	Within 1.2Km
Speed	1200/2400/4800/9600/19200bps (selectable)
Start bit	1 Bit fixed
Stop bit	1 Bit fixed
Parity bit	None
Data bit	8 Bit Fixed
Protocol	BCC

System Configuration

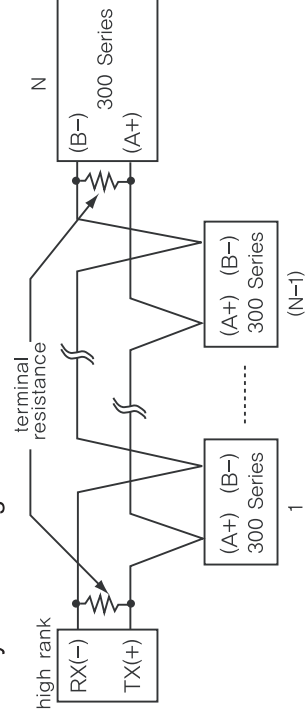

Definition of Communication Command and Block

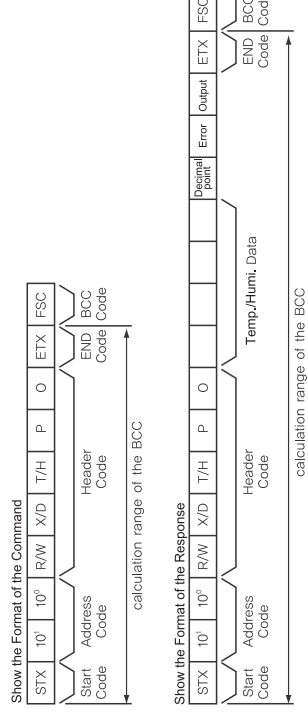

- Start Code**
 Displays the head of BLOCK.
 STX → [02H], ACK will be added in case of RESPONSE
- Address Code**
 A code of which the host system identifies FOX-300 series, and can be set from 01 to 99 (BCD ASCII).
- Header Code**
 The name of command is shown in text.
 RX(Read demand) → R[52H], X[58H]
 RD(Read response) → R[52H], D[44H]
 WX(Write demand) → W[57H], X[58H]

WD(Write response) → W[57H], D[44H]

TPO(Temp.measured value) → W[54H], F[50H], O[30H]

HPO(Humi.measured value) → H[48H], P[50H], O[30H]

④ Data Configuration

Data is expressed in Hexadecimal

⑤ Decimal point → 0[30H] No decimal point

1[31H] There is a decimal point

⑥ Error → 0[30H] No error,

1[31H] Sensor open error

2[32] Sensor short error

⑦ Output → 1[31H] T/H OUT ON

3[33H] T/H OUT OFF

⑧ END Code

Displays termination of Block. ETX → [03H]

⑨ BCC

Block Check Character. It shows the XOR operation value from the beginning (STX) protocol to ETX

• Others : If there is no ACK response

① If code numbers are inconsistent after receiving STX

② If Receive Buffer Overflow occurred

③ If borate or other communication SV is inconsistent

Handling when there is no ACK response

① Check the status of line.

② Check communication condition (SV).

③ In the case of communication abnormality caused by noise, perform communication for 3 times for recovery.

④ Change the communication speed if communication abnormality is too frequent.

12 Simple troubleshooting tip

■ If error is displayed while using the product:

- **Er-1** is displayed when the DATA memory element is damaged inside the product as it is affected by powerful noise from outside while in use. In this case, contact our company for customer service.
- While the controller is equipped with supplementary measures for outside noise, it cannot endure infinite noise.
- The interior of the product may be damaged if noise (2KV) is introduced.
- The sensor has defect when **Er-E** (Open Error) or **Er-E** (Short Error) is displayed. Please check the sensor.

* The above specification may be changed without prior notice for further improvement in performance.
 Please read and observe precautionary instructions during handling of the Product.

* Regarding the English-language manual, please download it at our web-site.

◆ Installation Precautions

- WARNING: To avoid the risk of electric shock, this equipment must be connected to protective grounding and to a supply voltage.
- Do not block the vents.

◆ Handling Precautions

* This instrument is suitable for the following environments.

- Ambient temp. : 0°C~60°C
- Ambient humi. : Less than 80% RH
- Used indoors only
- Pollution Degree 2
- Altitude : less than 2000m
- Installation Category II
- Avoid placing equipment that is difficult to operate power coding.
- Use of the equipment in a manner not specified by the equipment, manufacturer may impair the protection provided by the equipment.
- Rated power : 100~240Vac 50/60Hz 9VA

■ H. Office : 56, Ballyongsandan 1-ro, Jangnan-eup, Gijang, Busan, Republic of Korea

■ Factory : 56, Ballyongsandan 1-ro, Jangnan-eup, Gijang, Busan, Republic of Korea

■ TEL : +82-51-819-0426

■ FAX : +82-51-819-4562

■ e-mail : conotec@conotec.co.kr

■ URL : www.conotec.co.kr

- Major products and development
 - Digital temperature, humidity controller
 - Digital timer, current/voltage meter
 - Other product development