

Mushroom/Plant Cultivation, Indoor Air Cleansing System

FOX-8STC



Thank you for choosing the product of CONOTEC.

Please read 'Instruction Manual' thoroughly before using and use this product correctly.

Please put the manual on anyplace that can read it anytime.

It will be much easier to use the product after reading the manual.

Manual Version :V1.0

CONOTEC guarantees the best of best service.

Please contact the authorized agency in which you purchased this product for the inconvenient using or problem report.

※ The specifications can be changed without pre-notification for improvements of the product.

Please read this instruction manual thoroughly and abide it surely.

※ This measuring instrument is suitable for the following environment.

Surrounding Temperature : 0℃ ~ 60℃

Surrounding Humidity : Under 80%Rh

Rated Power : 220VAC ±10% 50/60Hz

■ Mainly produced products and developments

-Digital Temperature/Humidity Controller

-Digital Timer, Current/Voltage Meter

-Develop other products

Table of Contents

1. Cautions in using	3
2. Components	5
3. Product configuration & Panel processing size	6
4. Terminal Connection Wiring methods & Input/output specifications	7
5. Main Functions	8
6. Input keys	8
7. Major display units	9
8. Setting menu	10
9. Main menu	11
10. Environment setting menu	18
11. Set value in release	33
12. Output specifications	34
13. FS-600R	46

1 Cautions in using

Thank you for choosing the product of CONOTEC.

Please read the caution thoroughly to properly use our product.

Caution for your safety

Warning

1. product is not manufactured as a safety equipment. So, if you want to use it to control equipments that could cause lethal incident, damage on important peripheral device, or enormous damage on personal property, please attach double safety gears on it.
2. Please do not perform wiring, examination or maintenance repairing while the power is on.
3. Please check the terminal number when connecting it to the power.
4. This product must not be disassembled, processed, improved, nor repaired.

Caution

1. Please read thoroughly the instruction, safety regulations and warnings before installing this device. Moreover, please use this product within the boundary of regulated specifications and capacity.
2. Please do not wire or install the product on a motor or solenoid whose inductive load is huge.
3. Please use the same cable for sensor extension and do not overly extend the sensor.
4. Please do not use components that generate an electric arc when opening and closing the product on the same power source or near the source.
5. Please stay the power line away from the high tension line. Also, please do not install it at a place with a high amount of water, oil or dust.
6. Please do not install the device in a place where the device can be exposed to direct sunlight or rain water.
7. Please do not install the device in a place with strong magnetic forces, noise, vibration or shock.

8. Please stay the device away from a place with strong alkali or strong acid.
9. Please do not directly spray water on the device for cleansing if the device is installed at a kitchen.
10. Please do not install the device in a place where temperature and humidity exceed the rating.
11. Please do not let the sensor line be cut or cracked.
12. Please place the sensor line away from the signal line, power supply, power and load line and use an independent pipe.
13. Please note that if the device is arbitrarily disassembled, the after-service is not provided.
14. The mark on the terminal wiring diagram refers to warning or caution.
15. Please do not use the product near devices generating a high frequency noise such as high frequency welding machine, high frequency sewing machine, high frequency wireless set or bulk distribution SCR controller.
16. Any use beyond the usage boundary set by the manufacture can cause injury or property loss.
17. Since this device is not a toy, please put it away from kids.
18. The installation of the product must be done by a specialist or a qualified person.
19. If you do not abide by the warnings, caution or statements above or cause any damage or loss with your own mistake, we do not take responsibility for any of them.

 **Danger**

■ **Caution, Danger of an electric shock**

- * Electric shock – Please do not contact AC terminal while the electric current is being carried. You may be under the electric shock.
- * Please be sure to block the input power supply when you check the input power.

2 Components

Product



Manual

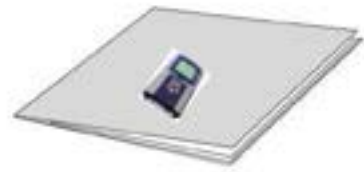

Stop bar



Provide when Commanding
Panel attaching type

FS-600R



Wall-hanging



Provide when Commanding
Wall-hanging type

FS-600R Bracket



3 Product configuration & Panel processing size

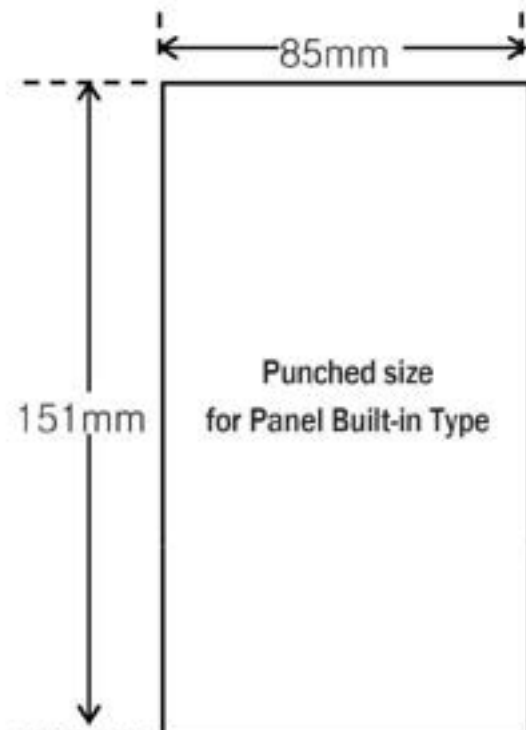
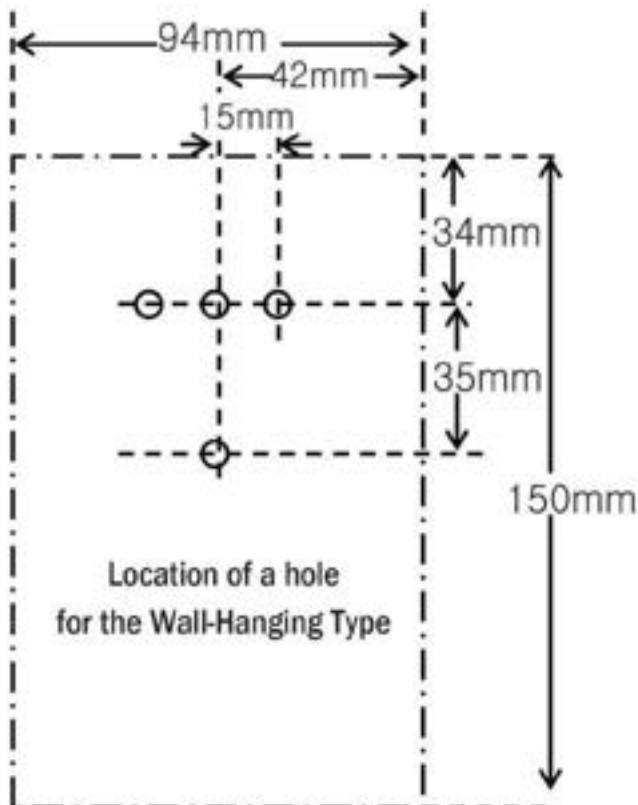
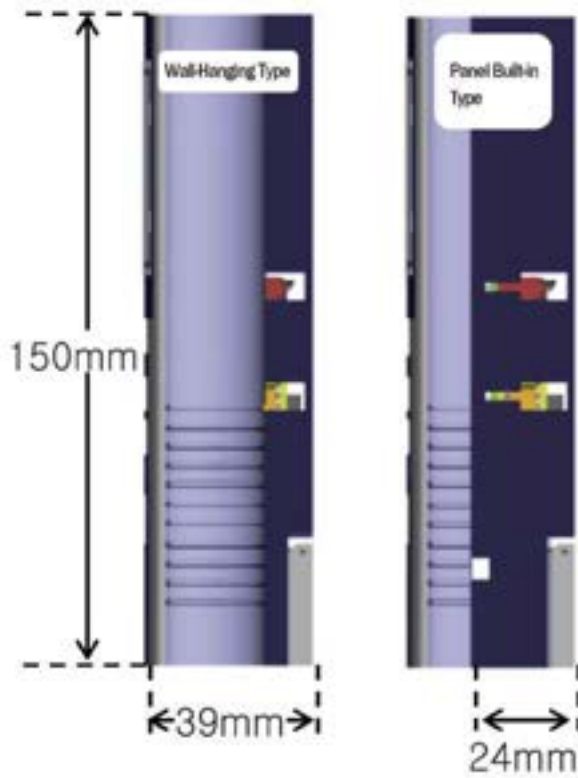

4 Terminal Connection Wiring methods & Input/output specifications

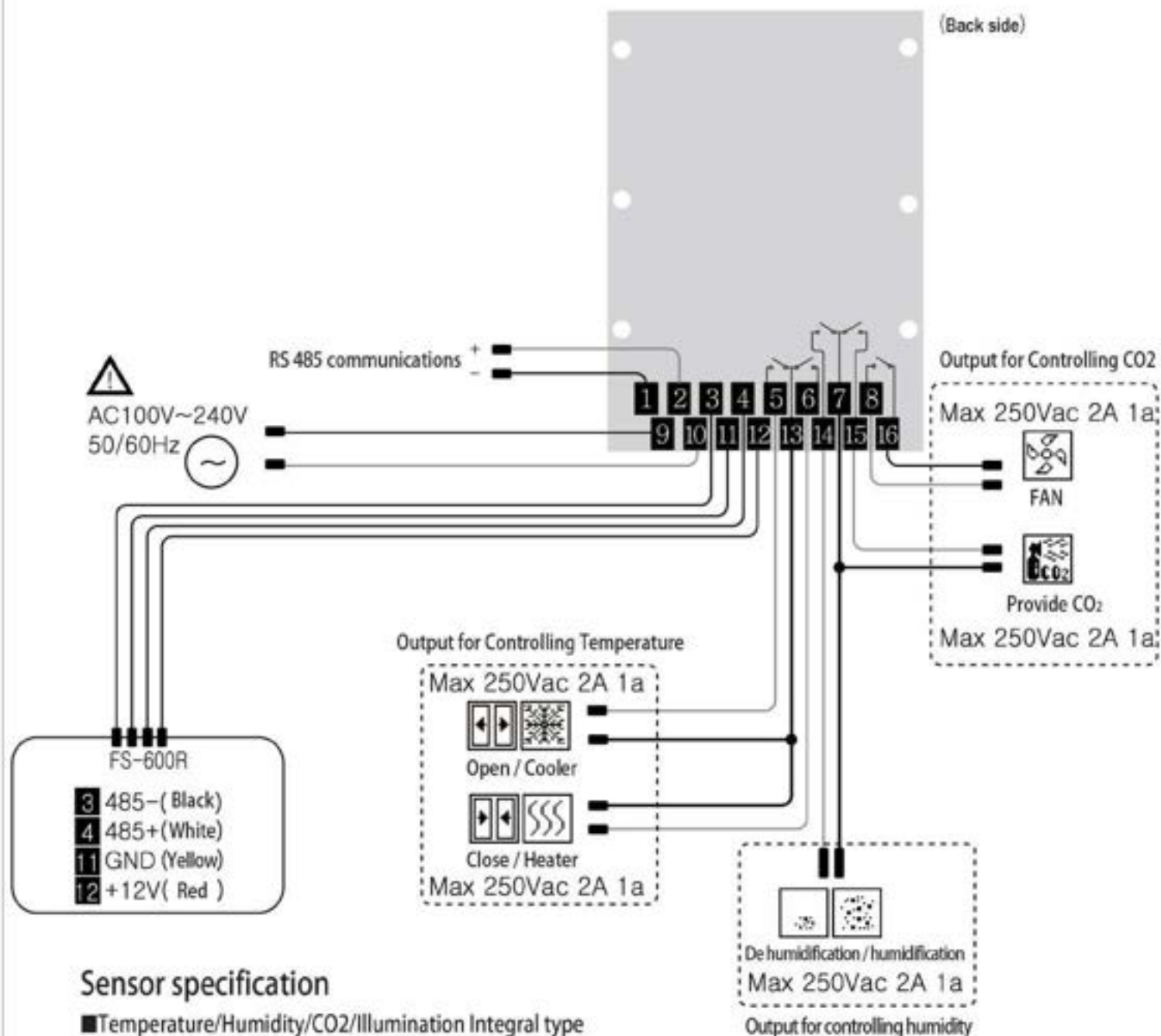

Sensor specification

■ Temperature/Humidity/CO2/Illumination Integral type

Model Name : FS-600R

- Temperature Range
- Temperature Accuracy
- Humidity Range
- Humidity Accuracy
- CO2 Range
- CO2 Accuracy
- Illumination Range
- Illumination Accuracy

5 Main Functions

Choose systems that are Mushroom/Plant cultivation and Indoor air cleaning

Users can choose one system among Mushroom/Plant cultivation and Indoor air cleaning systems fitting into using environment.

- * Mushroom/Plant cultivation : Create an environment suitable for cultivating mushrooms/plants by controlling temperature, CO₂, humidity and illumination with 9 channels for setting time
- * Indoor Air Cleaning : Create an environment suitable for indoor air by controlling temperature, CO₂, humidity and illumination with 9 channels for setting time

Control CO₂/Temperature/Humidity/Illumination

- * Mushroom/Plant cultivation : time setting by channels/Door open/close and temperature setting/ Humidity setting/ Illumination setting by sunny day and cloudy day / CO₂ setting and choose output
- * Indoor Air Cleaning : Temperature setting/ Humidity setting/ CO₂ (FAN) setting

RS 485 communications function (MODBUS-RTU)

High temperature/Low temperature, High humidity/Low humidity, High CO₂/Low CO₂ warning

Provide comfortable using environment by adopting Graphic LCD

Adopt highly précised digital temperature, humidity, CO₂ and illumination sensor

6 Input keys

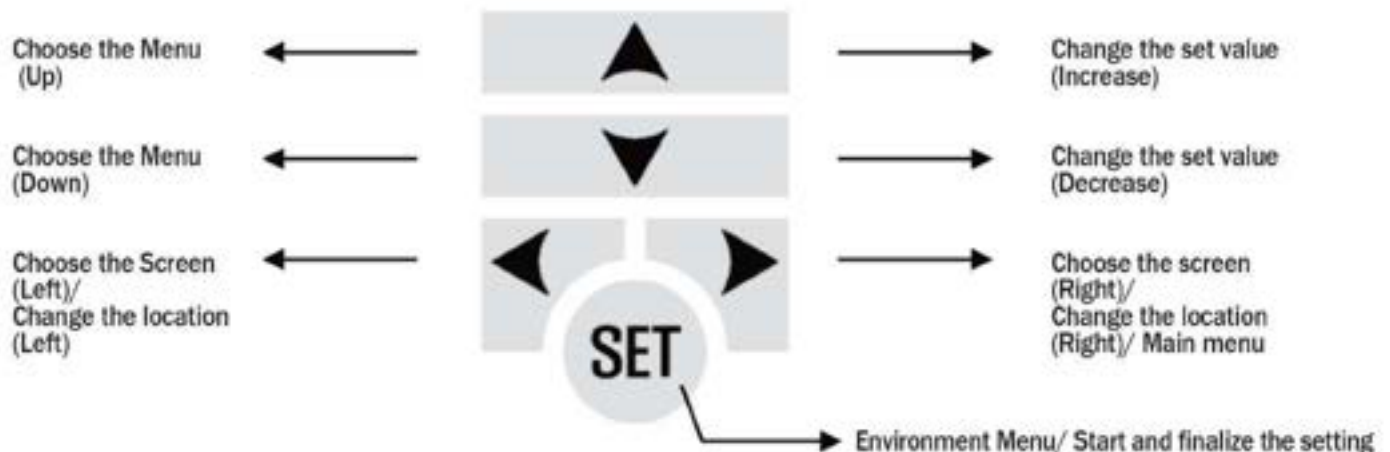

7

Major display units

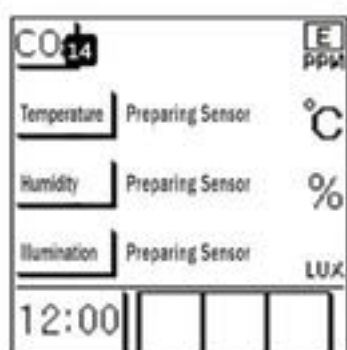
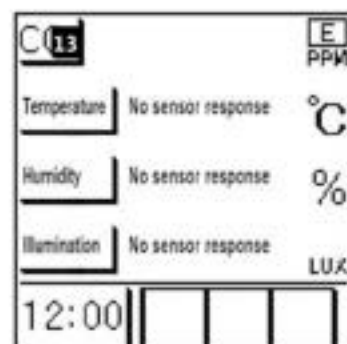
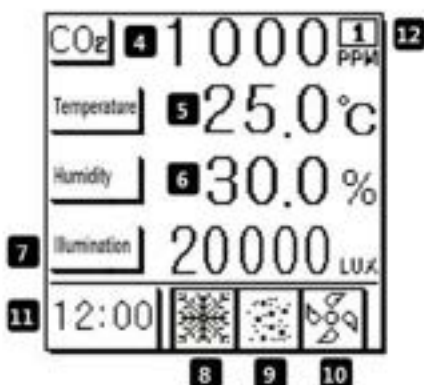

- 1** Company logo
- 2** Model name
- 3** Company phone number
- 4** Status of CO₂ sensor
- 5** Status of Temperature sensor
- 6** Status of Humidity sensor
- 7** Status of Illumination sensor
- 8** Express relay output regarding temperature - Expressed heater/cooler and open/close
- 9** Express relay output regarding humidity - Expressed dehumidification/ humidification
- 10** Express relay output regarding CO₂ - Expressed CO₂ supply/ FAN
- 11** Current time
- 12** LCD check box - Channel 1~9, A: Indoor Air Cleaning, P: Mushroom/Plant Cultivation, E: Express Error
- 13** Express Error - express cases such as Erroneous Wiring or different sensor number
- 14** Warm-Up - Prepare to measure the sensor when the sensor is on (Stabilization of the sensor)

8 Setting menu

Setting menus are divided to Main menu and Environment setting menu

Main Menu

- The items used frequently are allocated to the main menu.
- Menu items optimized to the user's choice, Mushroom/Plant cultivating mode or Indoor Air Cleaning Mode will be expressed.
- Please refer to the below table and check the output in line with operation mode and setting items.

Main menu setting

Operation mode		setting items	output
Mushroom/ Plant Cultivating mode	Set a channel	use the channel, set time	
	Control CO2	Sunny day CO2/Cloudy day CO2 (When On the illumination in detailed setting)	N/A Supply CO2 FAN
		Set CO2 (When Off the illumination in detailed setting)	
	Control temperature	Open 1 temperature/ Close 1 temperature (When choosing 1 phase of door open and close in detailed setting)	Open/Close
		Open 1 temperature / Close 1 temperature, Open 2 temperature difference/ close 2 temperature difference (When choosing 2 phases of door open and close in detailed setting)	
		Open/Close Temperature setting (When choosing temperature setting in detailed setting)	Cooler/Heater
Control Humidity	Setting humidity	Humidification / Dehumidification	
Indoor Air Cleaning Mode	Control CO2	Set CO2	FAN
	Control temperature	Set temperature	Cooler/Heater
	Control Humidity	Set Humidity	Humidification / Dehumidification

Environment Setting Menu

- Detailed setting items will be expressed in the screen to use the main menu.
- Temperature environment : Detailed setting items to control temperature will be expressed.
- Humidity environment : Detailed setting items to control humidity will be expressed.
- CO2 environment: Detailed setting items to control CO2 will be expressed.
- Alarming environment : Items to set the alarming status and ring the buzzer will be expressed
- Other environment : Items storing various set values and current time will be expressed.
- Communications environment : Items for 485 communications (Modbus RTU) will be expressed.

9 Main menu

Mushroom/Plant Cultivating Mode and Indoor Air Cleaning Mode can be chosen in Environment Setting Menu. The main menu will express the followings in line with user's choice.

Mushroom/Plant Cultivating Mode

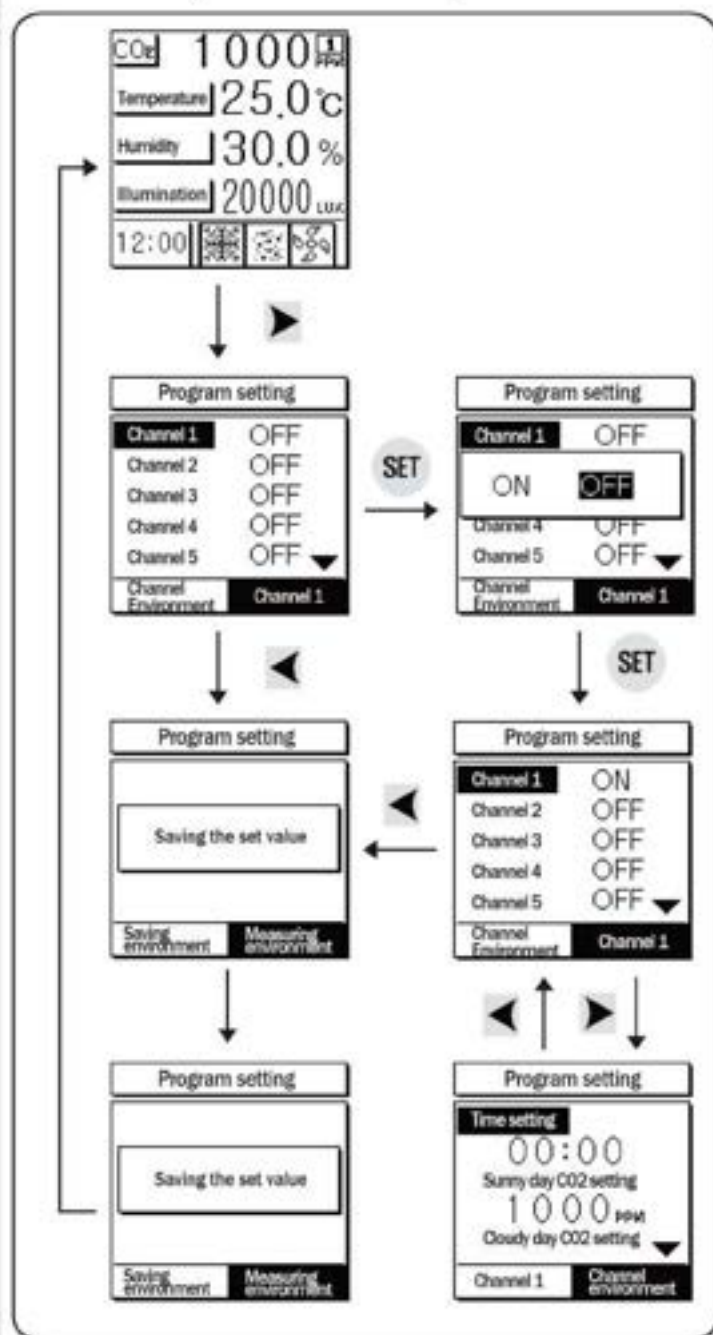

Indoor Air Cleaning Mode

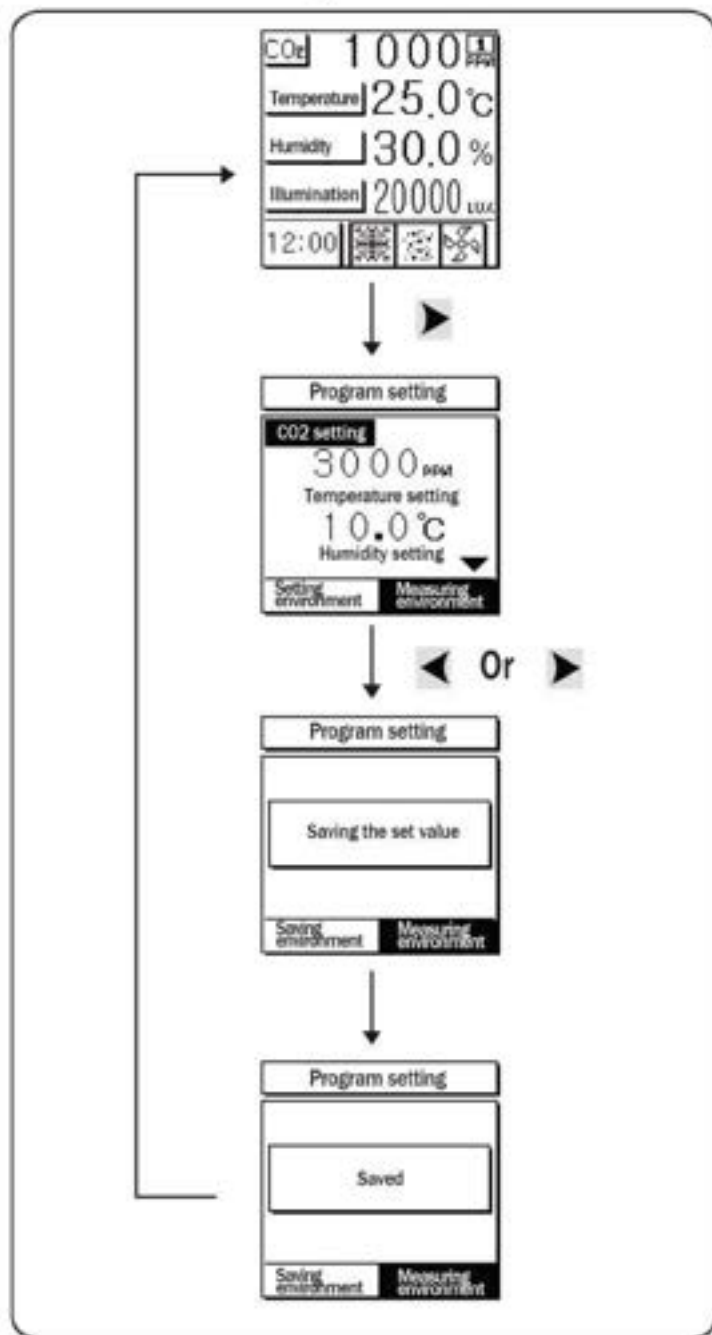

Detailed setting of the main menu in Mushroom/Plant Cultivating Mode

In case of mushroom/plant cultivation, 24 hours a day is divided by 9 channels and each channel controls Temperature/Humidity/CO2.

Temperature control is divided by two measures, door open/close control and Cooler/heater. In addition, CO2 control is divided by CO2 setting based on cloudy day and sunny day and simple CO2 setting in line with whether illumination sensor is used or not.

Channel environment

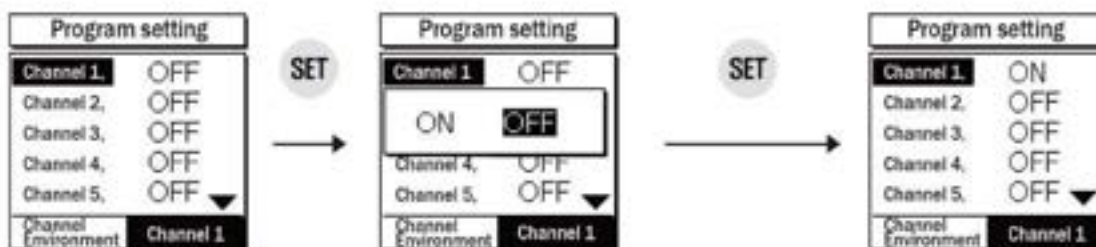

■ It can input 9 channels in maximum. It will moved to next channel when the user choose ON by channel.

Time setting

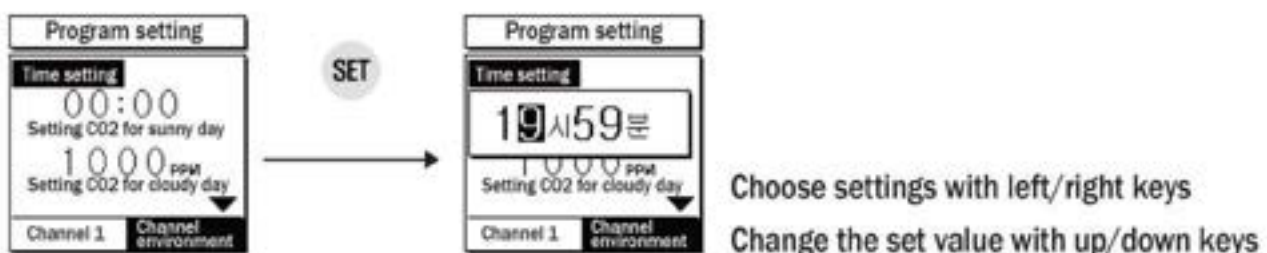

Example of setting a channel by time

Channel	Time setting	Operation time
Channel 1	04:00	04:00~07:10
Channel 2	07:10	07:10~10:30
Channel 3	10:30	10:30~12:00
Channel 4	12:00	12:00~16:20
Channel 5	16:20	16:20~18:40
Channel 6	18:40	18:40~20:05
Channel 7	20:05	20:05~23:00
Channel 8	23:00	23:00~04:00

Functions included in each channel are executed within the range of operating time.

*When Off the Channel 2

The range of Channel 1 is 0 minute to 23 hours 59 minutes

*When on the Channel 2

Range of Channel 1 < Channel 2 time setting

C02 setting

In case of Mushroom/Plant Cultivation, C02 setting menu will be different in line with the use of illumination sensor.

1. Setting C02 in Sunny day

- Expressed in setting 'Use Illumination(ON)' at the environment setting menu
- Conduct C02 controls as a set value of C02 in sunny day when the current illumination value is higher than set value of illumination in sunny day.



2. Setting C02 in cloudy day

- Expressed in setting 'Use Illumination(ON)' at the environment setting menu
- Conduct C02 controls as a set value of C02 in cloudy day when the current illumination value is lower than set value of illumination in sunny day and higher than set value of illumination in cloudy day



3. Set C02

- Expressed in setting 'Use Illumination(OFF)' at the environment setting menu
- Conduct C02 controls as a set value of C02 in cloudy day when the current illumination value is lower than set value of illumination in sunny day and higher than set value of illumination in cloudy day

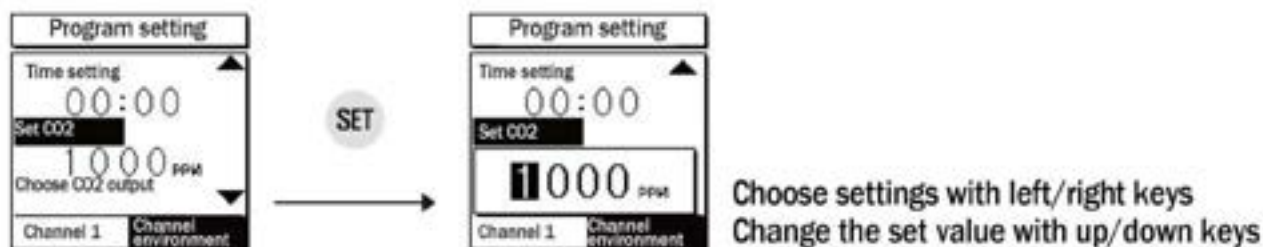

Choose C02 output



FAN output and C02 supply output can be selected in line with C02 and there will be no output in OFF.

Temperature setting

Temperature setting in mushroom/plant cultivation has 3 setting menu by choosing control door open/close (Can choose 1 phase and 2 phase) or temperature control at "Environment setting menu-temperature setting".

1. Door open/close 1st phase mode

- Will be applied when choosing "Environment setting menu- temperature environment- door open/close setting/ control 1 phase
- Be able to set open 1/ close 1 temperature as a function of opening and closing the door of vinyl house and so forth in line with the temperature
- The speed of opening and closing the door can be controlled at "Environment setting menu- temperature environment -time setting" by setting the time.

Set open 1 temperature

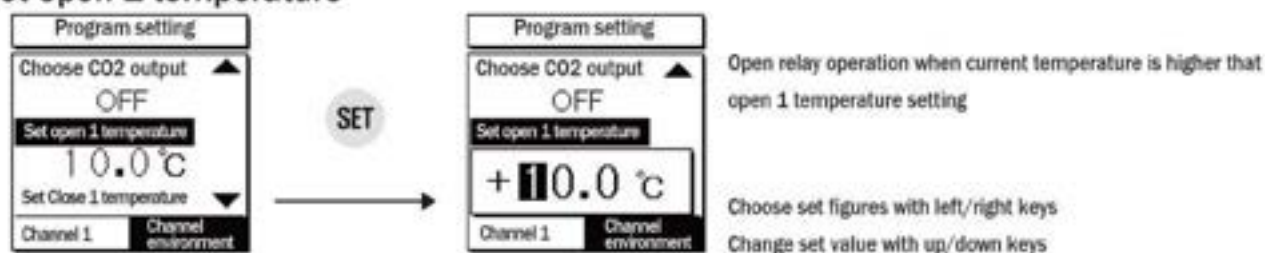

Set Close 1 temperature

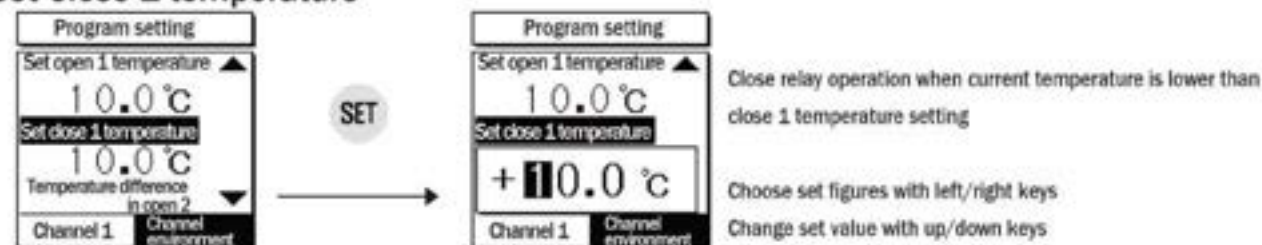

2. Door open/close 2nd phase mode

- Be applied when choosing "Environment setting menu - Temperature environment - door open/close setting / 2 phase control"
- Open 2 temperature difference /Close 2 temperature difference setting menu will be expressed including open 1 temperature/ close 1 temperature at 1st phase of door open and close additionally.
- The menu deciding the speed of close/open in 2nd phase control is located in "Environment setting menu -temperature environment - time setting".

Open 2 temperature difference

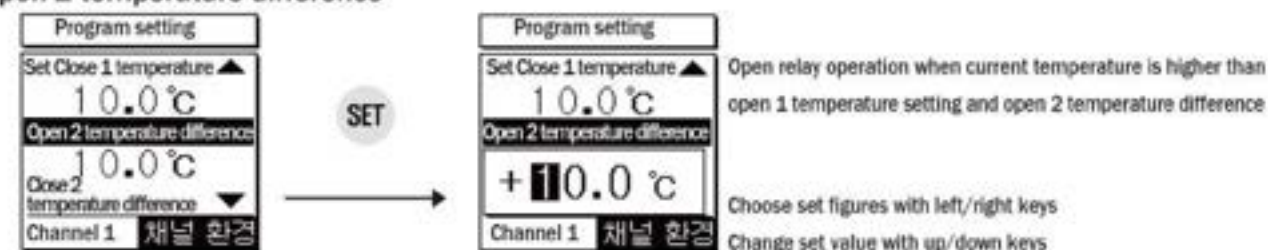

Close 2 temperature difference

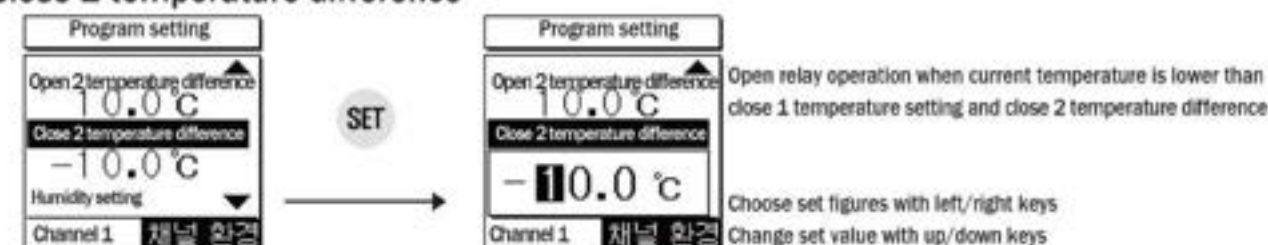

3. Temperature setting

- Be applied when setting "Environment Setting menu - Temperature environment - Temperature setting".
- Be used in controlling temperature at equipments such as cooler or heater.

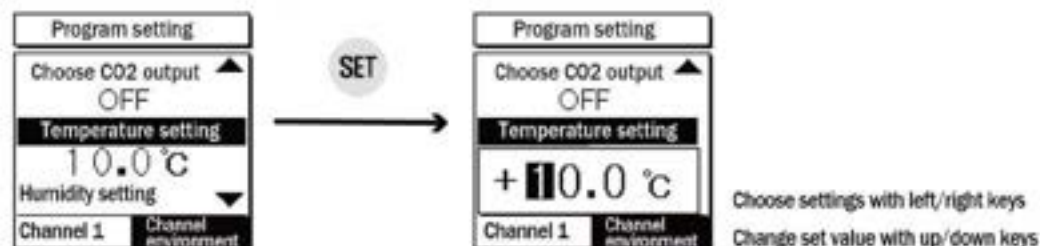

- Operate Cooler relay when current temperature is higher than that of setting temperature
Operate Heater relay when current temperature is lower than that of setting temperature

Humidity setting

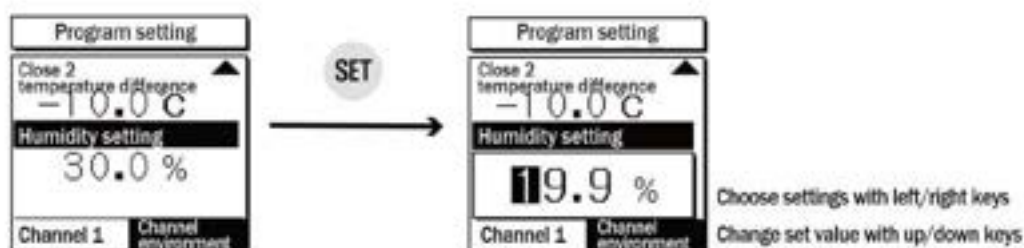

- Operate when choosing humidification or current humidity is lower than setting humidity
Operate when choosing dehumidification or current humidity is higher than setting humidity

Contents of main menu detailed setting in Indoor Air Cleaning Mode

The Indoor Air Cleaning Mode can simply set the CO₂/Temperature/humidity.

Functions like Illumination sensor and door open/close control cannot be used in this mode. In addition, only FAN output will be controlled in CO₂ control.

CO₂ setting

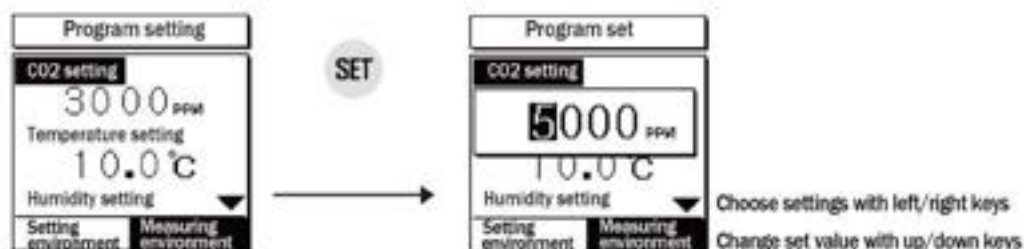

- Operate when current CO₂ is higher than that of set CO₂

Temperature setting

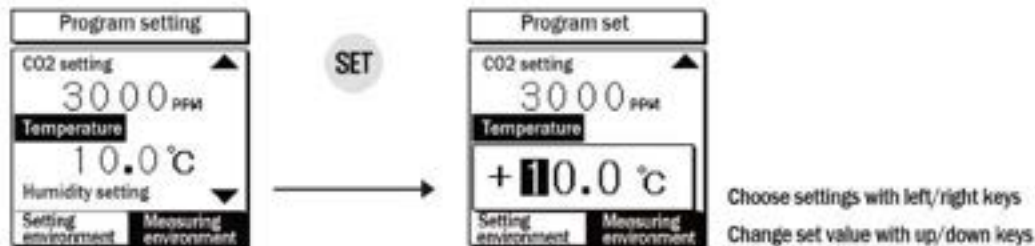

- Cooler relay operation when current temperature is higher than that of set temperature
- Heater relay operation when current temperature is lower than that of set temperature.

Humidity setting

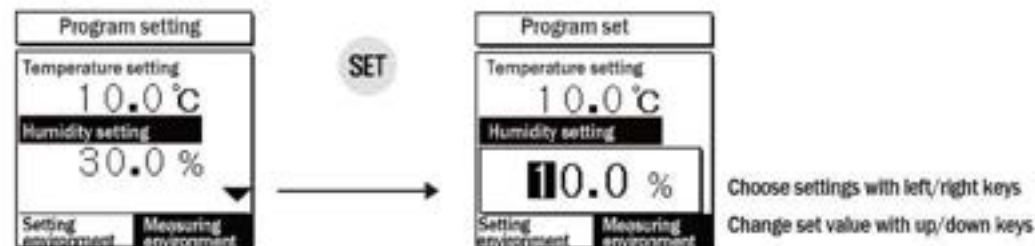

- Operate when choosing humidification or current humidity is lower than that of set humidity
- Operate when choosing dehumidification or current humidity is higher than that of set humidity

10 Environment Setting Menu

The menu of temperature environment and CO2 environment will be changed when a user chooses Mushroom/Plant Cultivating Mode and Indoor Air Cleaning Mode at Environment Setting Menu. In case of temperature environment, the menu will provide functions necessary to the users in line with user's choice of operation or 1/2 phase control in door open/close control. Details will be explained in next page.

It will be consisted with 6 kinds of temperature environment, humidity environment, CO2 environment, warning environment, other environment and communications environment.

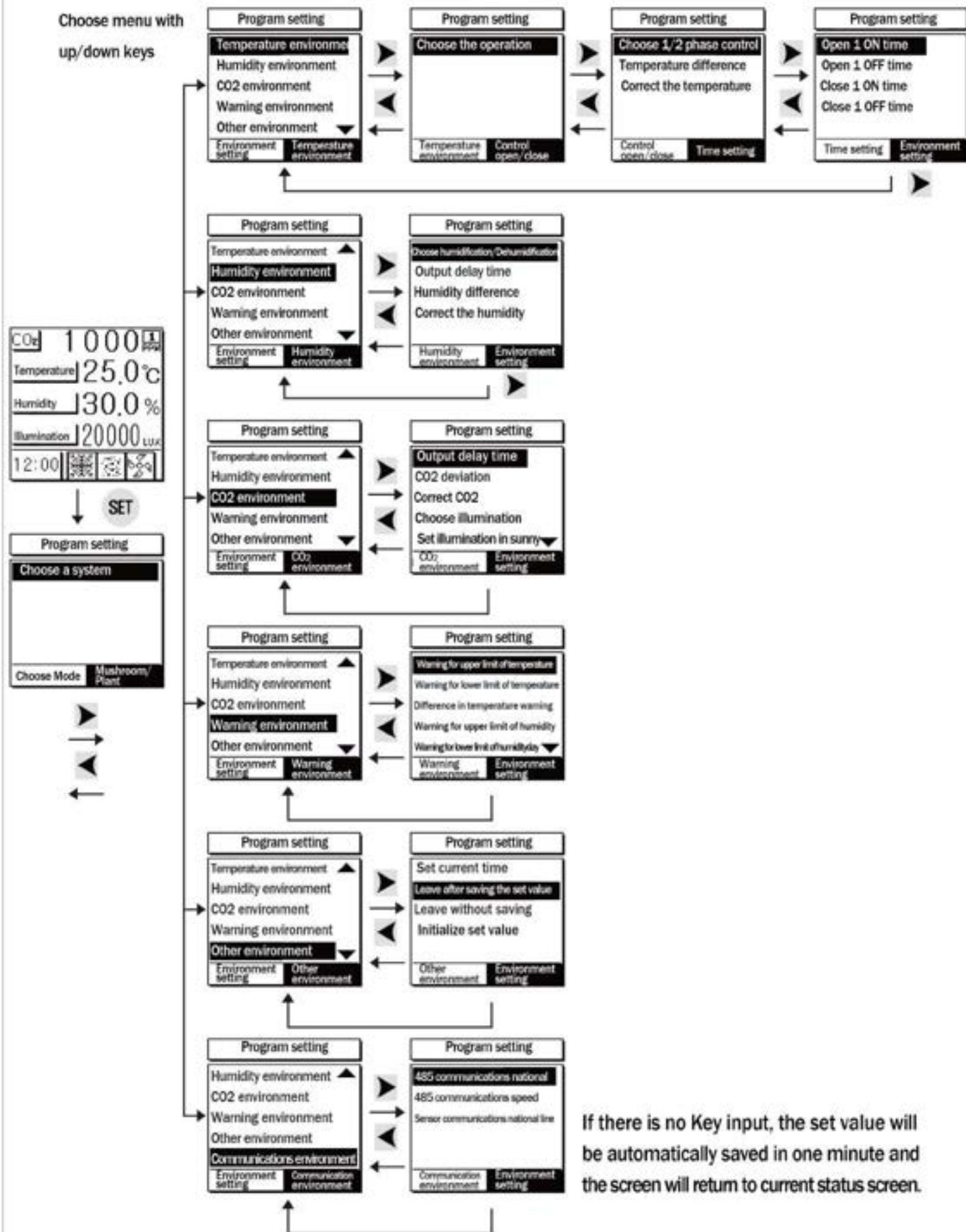

Contents of detailed setting for temperature environment

The detailed functions in Temperature environment menu will be changed in line with the user's choice and the users can see the needed functions.

Operation mode	Choose operation	Setting items	
Mushroom/ Plant Cultivating Mode	Door open/close control	Choose 1/2 phase control	Open 1 ON time, Open 1 OFF time Close 1 ON time, Close 1 OFF time (When choosing 1 phase) Open 1 ON time, Open 1 OFF time Close 1 ON time, Close 1 OFF time Open 2 ON time, Open 2 OFF time Close 2 ON time, Close 2 OFF time (When choosing 2 phase)
		Temperature difference	Temperature difference and temperature modification will be applied regardless of chosen operations in Mushroom/Plant Cultivating Mode. The output delay time is not needed in opening/closing a door so it will be used only when controlling the temperature. The menu of Indoor Air Cleaning Mode is the same with the menu of controlling temperature.
	Correct temperature		
	Temperature control	Output delay time	
		Temperature difference	
		Correct temperature	
Indoor Air Cleaning Mode		Output delay time	
		Temperature difference	
		Correct temperature	

Screen of controlling 1/2 phase when choosing the door open/close control in case of Mushroom/Plant Cultivating Mode

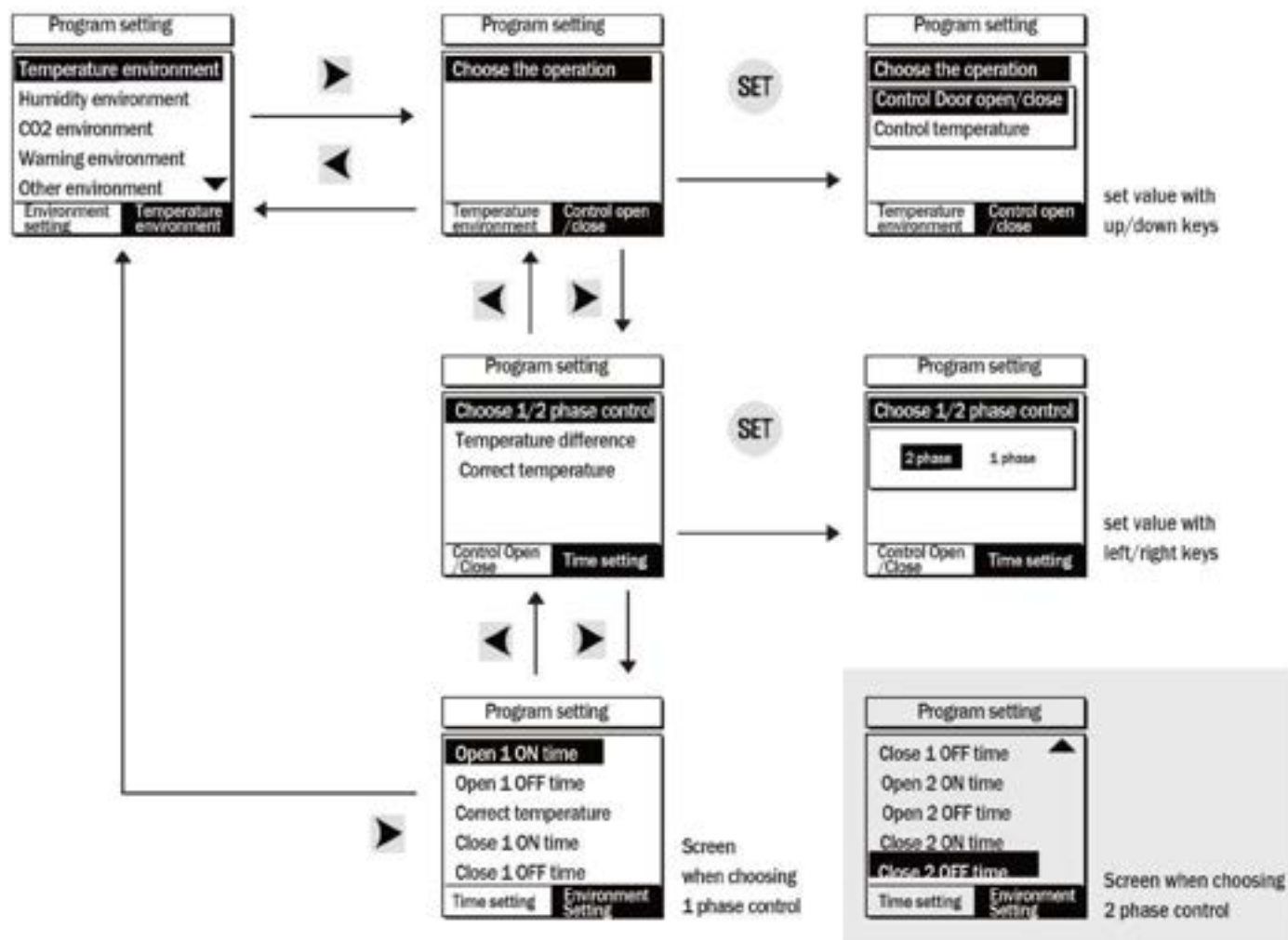

Screen when choosing temperature control in case of Mushroom/Plant Cultivating Mode

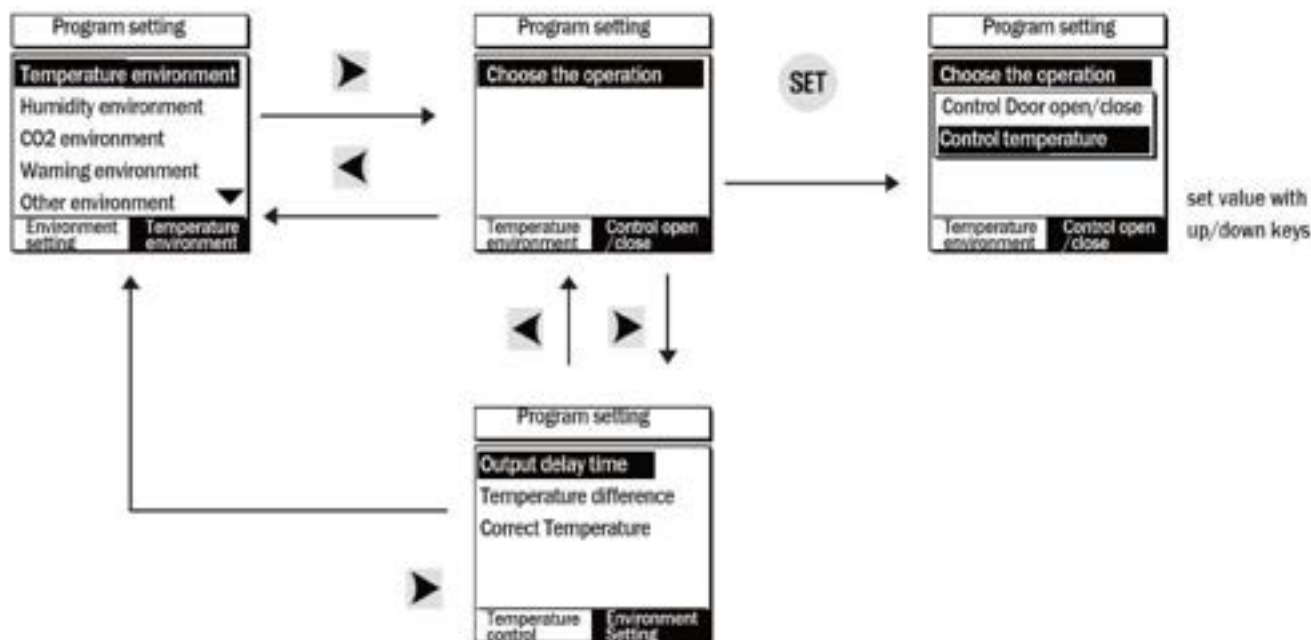

Screen of Indoor Air Cleaning Mode

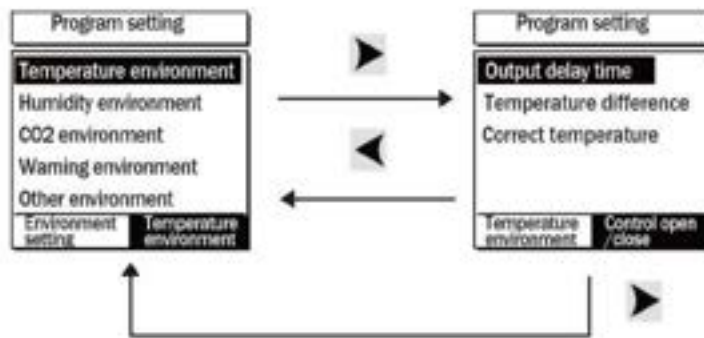

1 phase time control

★1/2 phase time control is a menu that sets the time of opening and closing the door when a user chooses the door open/close control.

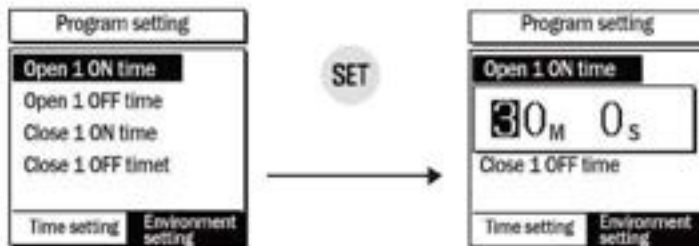

Choose settings with left/right keys
Change set value with up/down keys

- Open 1 phase control time : Open 1 ON time (Open operation ON)/ Open 1 OFF time (Open operation OFF)
- Close 1 phase control time: Close 1 ON time (Close operation ON)/Close 1 OFF time (Close operation OFF)

Each channel is commonly applying Open 1 ON time, Open 1 OFF time, Close 1 ON time and Close 1 OFF time. Please refer to Page 34 for detailed example.

2 phase time control

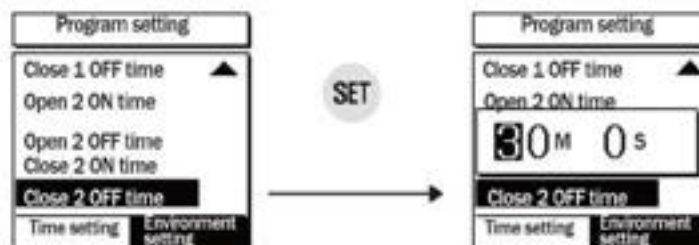

Choose settings with left/right keys
Change set value with up/down keys

- Open 2 phase control time : Open 2 ON time (Open operation ON)/ Open 2 OFF time (Open operation OFF)
- Close 2 phase control time: Close 2 ON time (Close operation ON)/Close 2 OFF time (Close operation OFF)

2 phase time control is a measure to prevent damages against agricultural product by setting the time of opening and closing a door differently for a case that temperature is suddenly going up or down. Each channel is commonly applying open 1 ON time, Open 1 OFF time, Close 1 ON time, Close 1 OFF time, Open 2 ON time, Open 2 OFF time, Close 2 ON time and Close 2 OFF. Please refer to page 35 for detailed example.

Temperature Difference

★ It will be commonly applied when controlling Door Open/Close and Temperature.

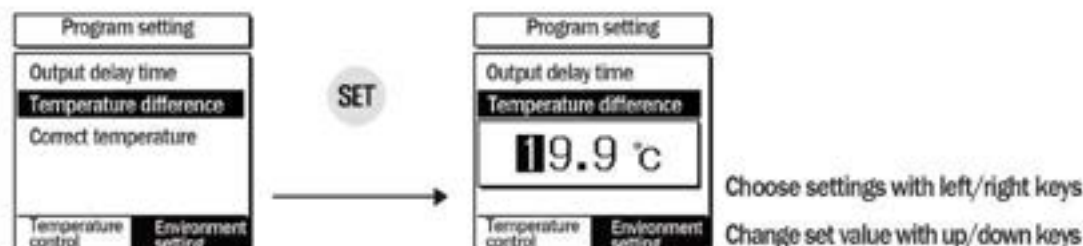

- Certain interval is needed between On and OFF for On/OFF control (Set the interval between ON/OFF) If On and OFF are operated too often, relay or output contact will be worn rapidly or hunting (Chattering, Oscillation) will occur due to outside noise. To prevent these phenomena, setting temperature difference to protect contact of equipment or others shall be needed.

Correct Temperature

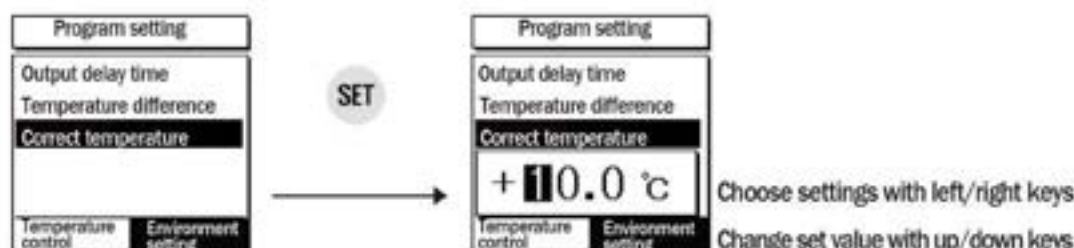

- It is a function of correction that there is an error on the sensor inputted outside even though the product itself does not have any problems or the temperature between standard temperature (Ex. Mercury Thermometer, Currently using thermometer or temperature controller) and temperature is different.

Ex.) When the expressed temperature is 25.0°C but the actual temperature is 27.0°C, set +2.0°C as a correction value of the temperature sensor. Then, the expressed temperature of the product will be $25.0+2.0=27.0^{\circ}\text{C}$.

Output Delay Time

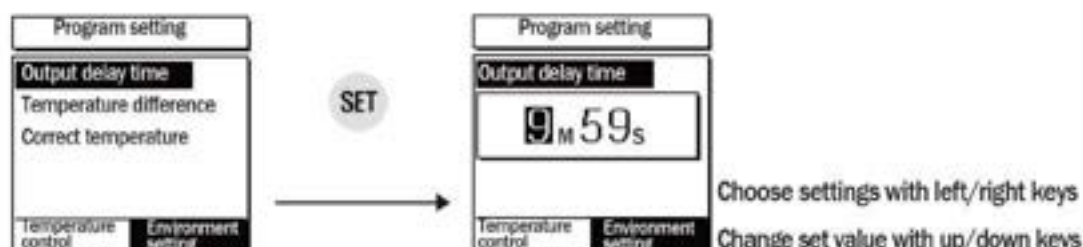

- Use this function when there is a problem due to frequent use of ON/OFF operation by controlling targets such as a refrigerator and compressor. Function of protecting operating machine when there is a power failure or supplying power again.

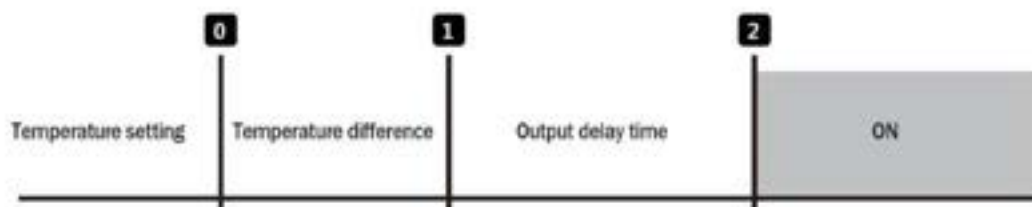

EX.) If the set value is one minute, the relay will be ON at the second place after delaying one minute taken from the first place to second place.

Contents of detailed setting for humidity environment

Operation mode	Setting items	
Commonly applied to Mushroom / Plant Cultivation mode and Indoor Air Cleaning Mode	Choose Humidification/Dehumidification	Please refer to page 38 for the example of using humidification and dehumidification
	Output delay time	
	Humidity Difference	
	Correct Humidity	

Choose Humidification/Dehumidification

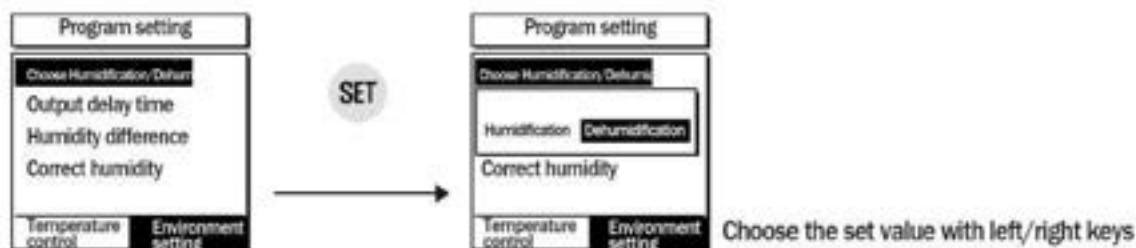

- Can choose humidification and dehumidification

Output Delay Time

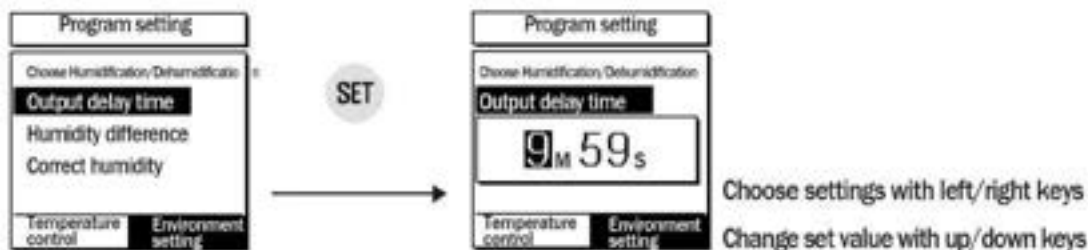

- Use this function when there is a problem due to frequent use of ON/OFF operation by controlling targets such as a refrigerator and compressor.
Function of protecting operating machine when there is a power failure or supplying power again.

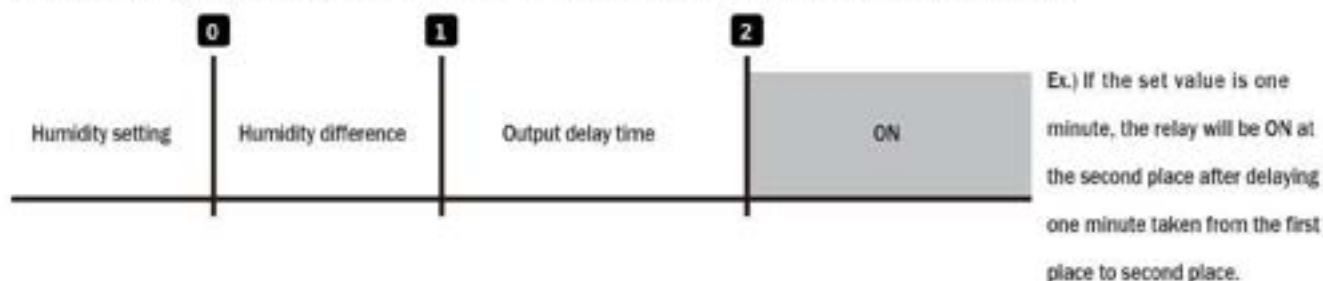

Humidity difference

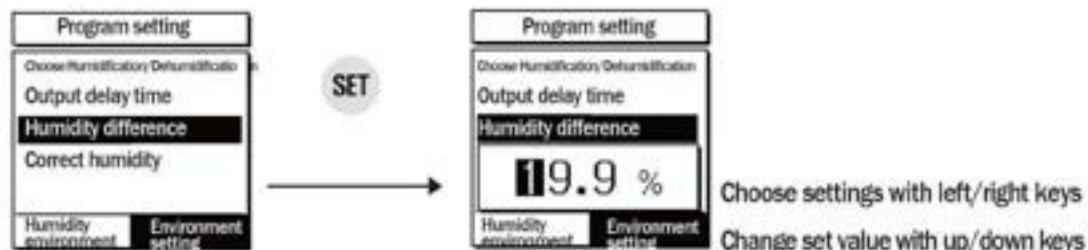

- Certain interval is needed between ON and OFF for ON/OFF control (Set the interval between ON/OFF)
If On and OFF are operated too often, relay or output contact will be worn rapidly or hunting (Chattering, Oscillation) will occur due to outside noise. To prevent these phenomena, setting temperature difference to protect the contact of equipment or others shall be needed.

Correct humidity

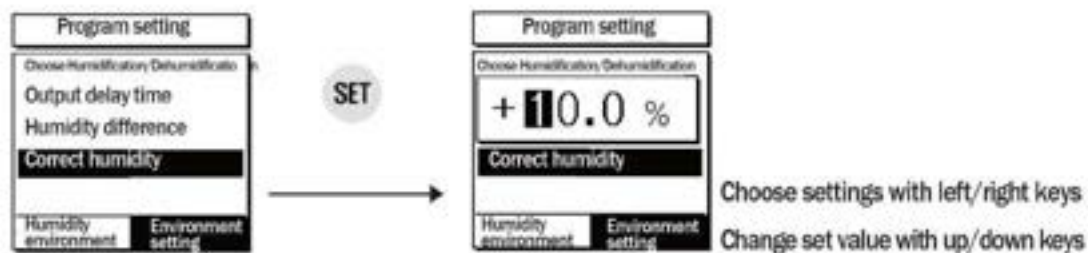

- It is the function of matching the hygrometer of this product to other precision hygrometer if there is difference between these two hygrometers.
Ex. If expressed humidity is 25.0% and real humidity is 27.0%, set +2.0% as a correction value of the humidity sensor to make expressed temperature be $25.0+2.0=27.0\%$.

Contents of detailed setting for CO2 environment

The detailed function of CO2 environment menu will be changed in line with user's choice of an operation mode to provide functions necessary to the user.

Operation mode	Setting items
Mushroom/Plant Cultivating mode	Output delay time
	CO2 difference
	CO2 correction
	Choose Illumination
	Illumination setting in sunny day
	Illumination setting in cloudy day
Indoor Air Cleaning Mode	Output delay time
	CO2 difference
	CO2 correction

In case of Mushroom/Plant Cultivating Mode, users can conveniently harvest mushrooms or plants by using the illumination. Please refer to the page 36 for the example of using illumination in detail.

In case of Indoor Air Cleaning Mode, monitoring will be the only function without illumination control function.

Screen of Mushroom/Plant Cultivating Mode

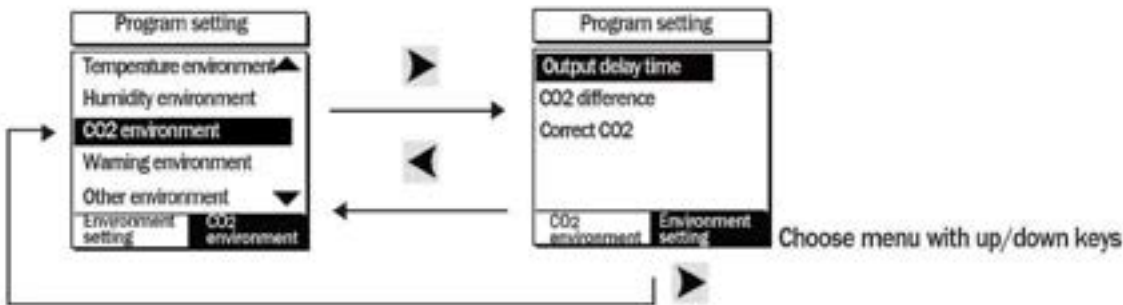
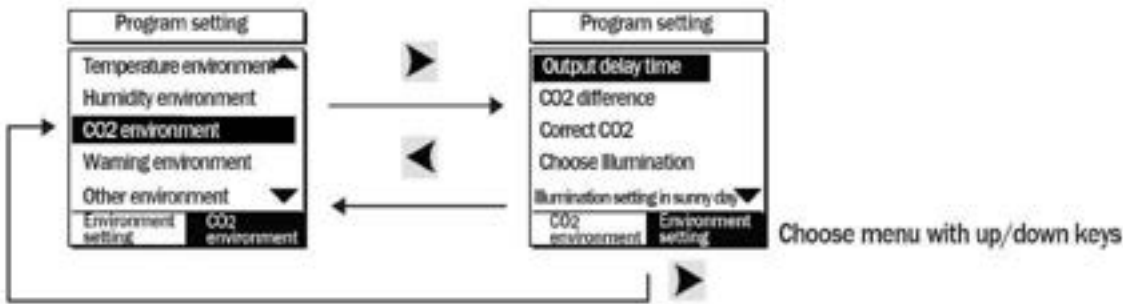

Output delay time

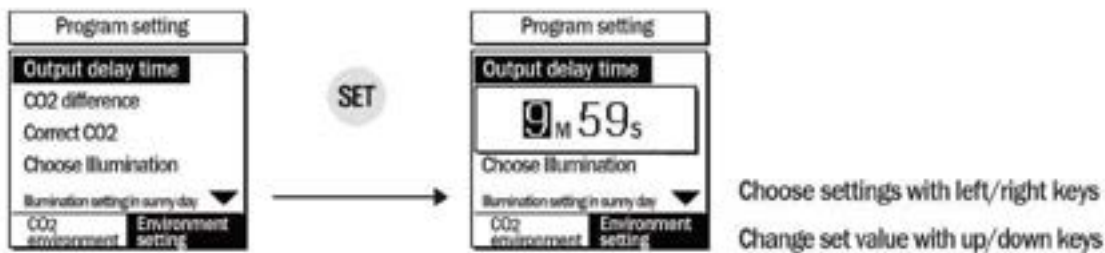

- Use this function when there is a problem due to frequent use of ON/OFF operation by controlling targets such as a refrigerator and compressor.
Function of protecting operating machine when there is a power failure or supplying power again.

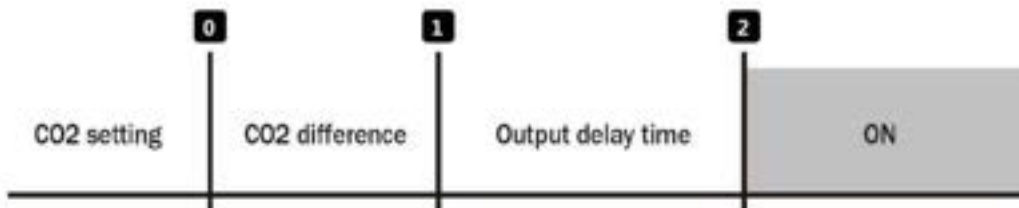

Ex.) If the set value is one minute, the relay will be ON at the second place after delaying one minute taken from the first place to second place.

CO2 difference

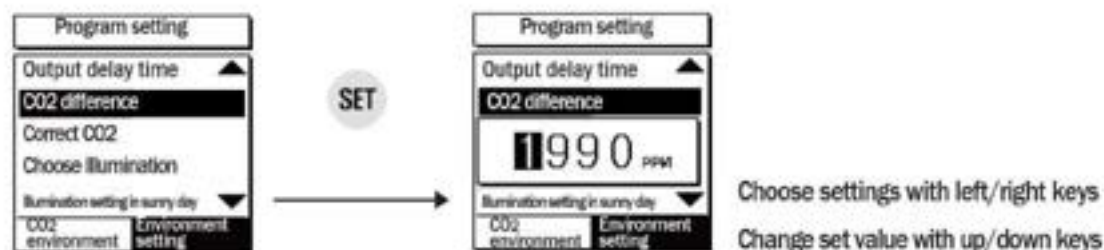

- Certain interval is needed between ON and OFF for ON/OFF control (Set the interval between ON/OFF)
If On and OFF are operated too often, relay or output contact will be worn rapidly or hunting (Chattering, Oscillation) will occur due to outside noise. To prevent these phenomena, setting temperature difference to protect contact of equipment or others shall be needed.

Correct CO2

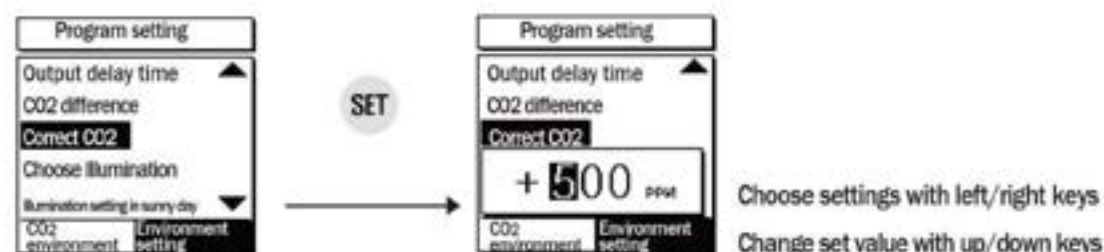

- It is a function of consisting CO2 of this product with other precision CO2 system when comparing CO2 expressed in the product and other precision CO2 system.
Ex. If expressed CO2 is 1000ppm and real CO2 is 1100ppm, set +100ppm as a correction value of the CO2 sensor to make $1000\text{ppm}+100\text{ppm}=1100\text{ppm}$

Choose Illumination



- Decide whether to choose illumination with ON and OFF.

Illumination setting in sunny day

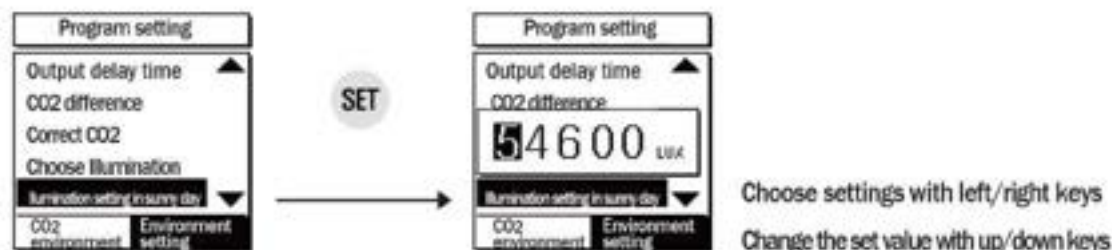

- The set value of CO2 will be different in line with the illumination by designating the illumination setting in sunny day

Illumination setting in cloudy day

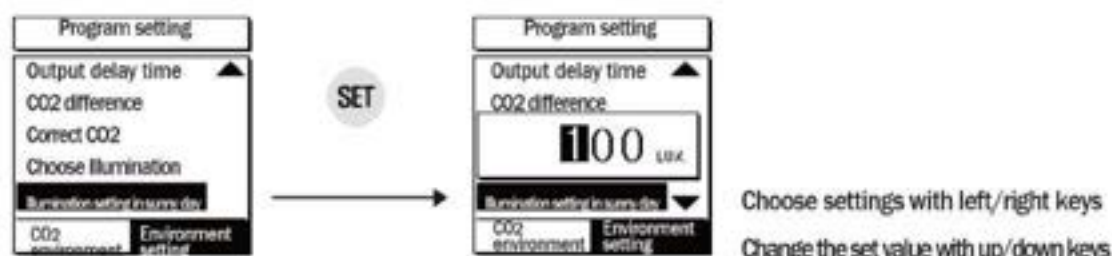

- The set value of CO2 will be different in line with the illumination by designating the illumination setting in cloudy day

Contents of detailed setting for warning environment

Operation mode	Setting items	
Commonly applied to Mushroom /Plant Cultivating Mode and Indoor Air Cleaning Mode	Temperature upper limit warning	It is a function of letting the user know the abnormal signal by ringing a buzzer when the measured value is lower or higher than the lower limit or upper limit respectively after setting upper limit and lower limit of temperature/humidity/CO2. The details will be explained in next page.
	Temperature lower limit warning	
	Difference in temperature warning	
	Humidity upper limit warning	
	Humidity lower limit warning	
	Difference in humidity warning	
	CO2 upper limit warning	
	CO2 lower limit warning	
	Difference in CO2 warning	
Setting warning time		

Temperature upper limit warning

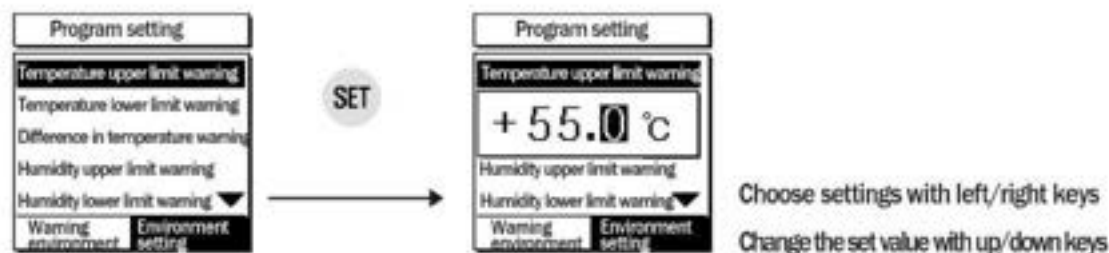

- Setting a point that makes warning against high temperature when current temperature is higher than that of a certain temperature.

Warning against high temperature: When current temperature is higher than set value of temperature upper limit (Buzzer ON)

Lift after warning against high temperature: when current temperature is lower than 'Set value of temperature upper limit - Set value of difference in temperature warning' (Buzzer OFF)

Temperature lower limit warning

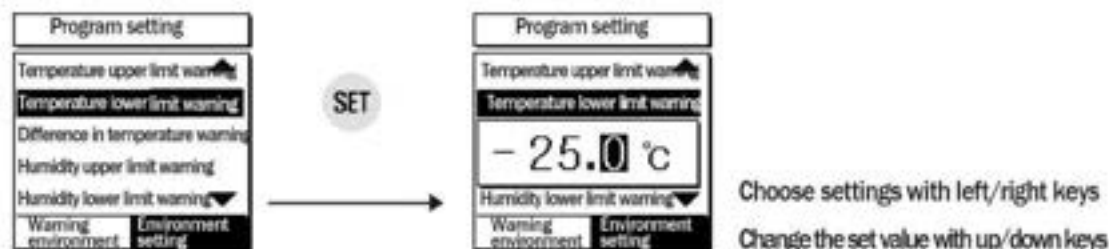

- Setting a point that makes warning against low temperature when current temperature is lower than that of a certain temperature.

Warning against low temperature: When current temperature is lower than set value of temperature lower limit (Buzzer ON)

Lift after warning against low temperature: when current temperature is higher than 'Set value of temperature low limit - Set value of difference in temperature warning' (Buzzer OFF)

Difference in temperature warning

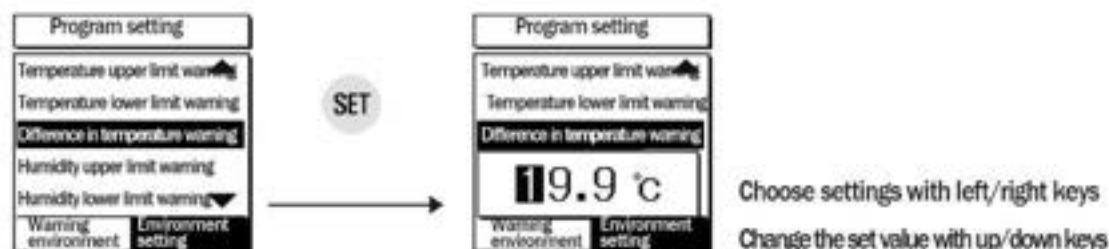

- Set a hysteresis interval between warning ON and OFF. It will be applied to high temperature warning as well as low temperature warning.

Humidity upper limit warning

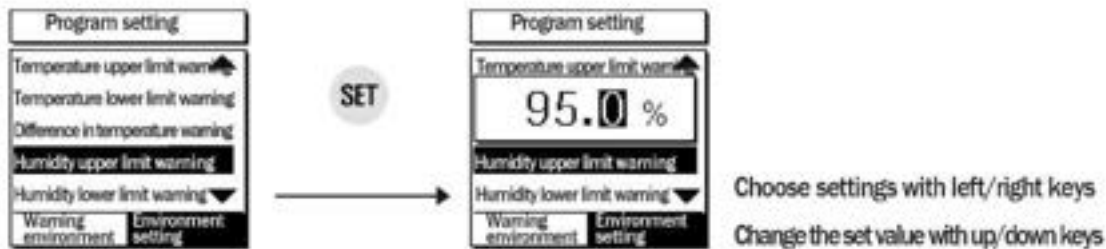

- Setting a point that makes warning against high humidity when current humidity is higher than that of a certain humidity.

Warning against high humidity: When current humidity is higher than set value of humidity upper limit (Buzzer ON)

Lift after warning against high humidity: when current humidity is lower than 'Set value of humidity upper limit - Set value of difference in humidity warning' (Buzzer OFF)

Humidity lower limit warning

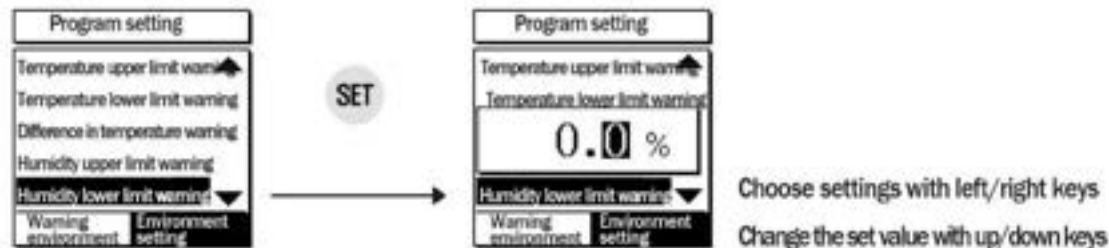

- Setting a point that makes warning against low humidity when current humidity is lower than that of a certain humidity.

Warning against low humidity: When current humidity is lower than set value of humidity lower limit (Buzzer ON)

Lift after warning against low humidity: when current humidity is higher than 'Set value of humidity lower limit - Set value of difference in humidity warning' (Buzzer OFF)

Difference in Humidity warning

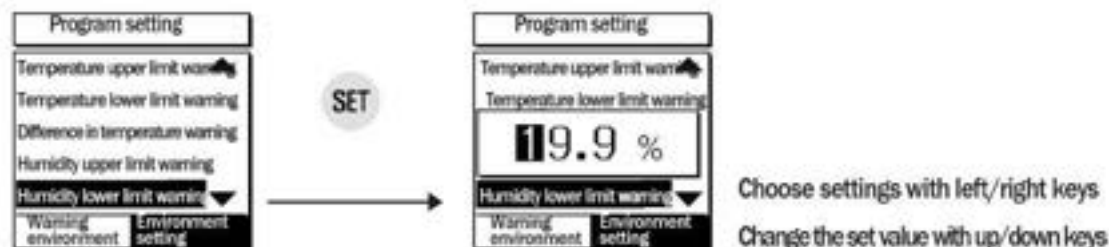

- Set a hysteresis interval between warning ON and OFF. It will be applied to high humidity warning as well as low humidity warning

C02 upper limit warning

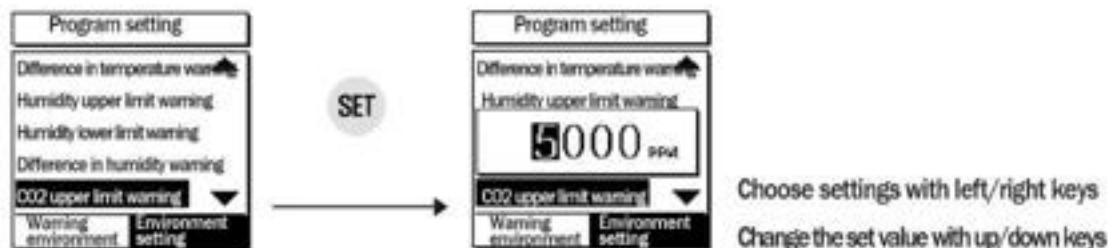

- Setting a point that makes warning against high CO2 when current CO2 is higher than that of a certain CO2.
 Warning against high CO2 : When current CO2 is higher than set value of CO2 upper limit (Buzzer ON)
 Lift after warning against high CO2 : when current CO2 is lower than 'Set value of CO2 upper limit - Set value of difference in CO2 warning' (Buzzer OFF)

C02 lower limit warning

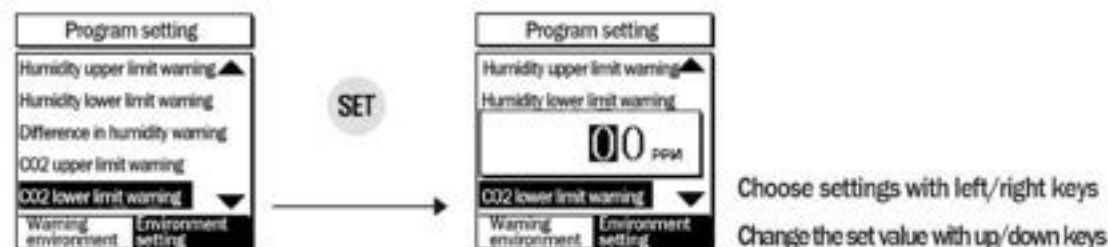

- Setting a point that makes warning against low CO2 when current CO2 is lower than that of a certain CO2 .
 Warning against low CO2 : When current CO2 is lower than set value of CO2 lower limit (Buzzer ON)
 Lift after warning against low CO2 : when current CO2 is higher than 'Set value of CO2 lower limit - Set value of difference in CO2 warning' (Buzzer OFF)

C02 lower limit warning



- Set a hysteresis interval between warning ON and OFF. It will be applied to high CO2 warning as well as low CO2 warning

Warning time setting



- The buzzer will be ON during warning time and the buzzer will be OFF when setting the warning time as 0 second

Contents of detailed setting for other environment

Current time setting



- Change the time if the time in measuring screen is not consistent with the correct time

Leave after saving



- ON : Leave the setting menu after saving the changed set values on the memory
- OFF: Be able to continue the setting process

Leave without saving

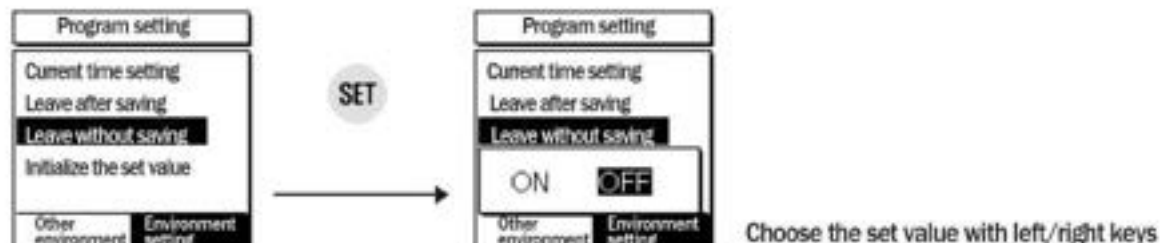

- ON : Leave the setting menu not saving the changed set values on the memory
- OFF: Be able to continue the setting process

Initialize the set value



- ON : It is a function of initializing all set values to the status of releasing the product
- OFF: Be able to continue the setting process

Contents of detailed setting from communications environment

485 communications national line

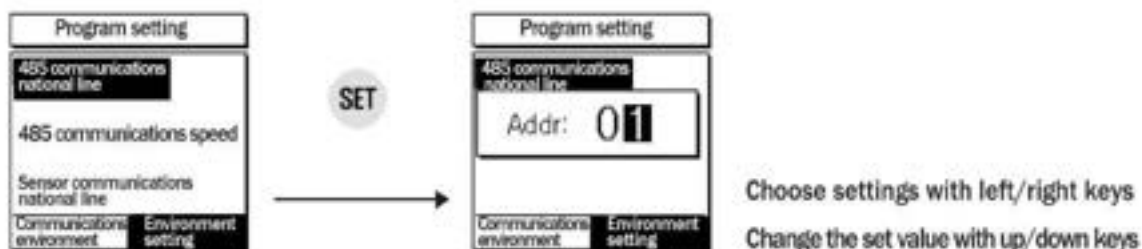

- The communication address will be assigned from No.1 to No.99 on each device for serial communication. It is used to identify each device.

485 communications speed



- It is the communication speed for serial communications. It shall be in line with the HOST system and speed such as PC.

Sensor communications national line



- It is an ID that request measured values to FS-600R (Sensor) by making 8STC main host.

For example, if set the sensor communication national line ID as No.1 and switch on the ID No.1 of FS-600R, it will bring up the measured value after searching the same ID.

It can read up to 9 channels. Please refer to page 49 for details on the sensor switch.

11 Set value in release

	Setting items	Default value (Value in release)	Setting range
Temperature group	Choose operation	Control Door Open/Close	Temperature control/Door open-close control
	Choose 1st phase/2nd phase control	1st phase	1st phase/2nd phase
	Temperature difference	1.0℃	0.1 ~ 19.9℃
	Correct temperature	0.0℃	-10.0 ~ +10.0℃
	Output delay time	1'	0'-9'59"
	Open 1 ON time	10'	0'-29'59"
	Open 1 OFF time	60'	0'-29'59"
	Close 1 ON time	10'	0'-29'59"
	Close 1 OFF time	60'	0'-29'59"
	Open 2 ON time	10'	0'-29'59"
	Open 2 OFF time	60'	0'-29'59"
	Close 2 ON time	10'	0'-29'59"
	Temperature upper limit warning	95.0℃	Temperature lower limit - +65.0℃
	Temperature lower limit warning	-20.0℃	temperature upper limit
	Difference in temperature warning	1.0℃	0.1 ~ 19.9℃
	Temperature setting	10.0℃	-20.0 ~ +65.0℃
	Set open 1 Temperature for each CH	10.0℃	Set close 1 Temperature for each CH +65.0℃
	Set close 1 temperature for each CH	10.0℃	-20.0℃ - Set open 1 Temperature for each CH
Temperature difference of open 2 for each CH	10.0℃	0.1 ~ 65.0℃	
Temperature difference of close 2 for each CH	-10.0℃	-20.0 ~ -0.1℃	
Humidity group	Choose humidification/dehumidification	Dehumidification	Dehumidification/Humidification
	Output delay time	1'	0'-9'59"
	Humidity difference	1.0%	0.1 ~ 19.9%
	Correct humidity	0.0%	-10.0 ~ +10.0%
	Humidity upper limit warning 95.0%	95.0%	Humidity lower limit -100.0%
	Humidity lower limit warning	0.0%	0.0%-Humidity upper limit
	Difference in humidity warning	1.0%	0.1 ~ 19.9%
	Humidity setting, 30.0%	30.0%	0.0 ~ 100.0%
	Humidity setting for each CH	30.0%	0.0 ~ 100.0%
CO2 group	Output delay time	1'	0'-9'59"
	CO2 difference	100ppm	10 ~ 1990ppm
	Correct CO2	0ppm	-500 ~ +500ppm
	CO2 upper limit warning	5000ppm	CO2 lower limit - 5000ppm
	CO2 lower limit warning	0ppm	0ppm-CO2 upper limit
	Difference in CO2 warning	100ppm	10 ~ 1990ppm
	CO2 setting, 1000ppm	1000ppm	0 ~ 5000ppm
	CO2 setting for each CH in sunny day	1000ppm	0 ~ 5000ppm
	CO2 setting for each CH in cloudy day	1000ppm	0 ~ 5000ppm
	Choose CO2 output of each CH	OFF	OFF/supply CO2/FAN

Setting items		Default value (value in release)	Setting range
Illumination group	Choose Illumination	OFF	OFF/ON
	Illumination setting in sunny day	23000Lux	Illumination setting in cloudy day - 54600Lux
	Illumination setting in cloudy day	1000Lux	10Lux- Illumination setting in sunny day
Other group	Choose system	Mushroom/Plant cultivation	Indoor Air Cleaning/Mushroom and plant cultivation
	Warning time	0'	0'-59'59"
	485 communications national line	No. 1	No.1-99
	485 communications speed	9600bps	1200/2400/4800/9600/19200bps
	Sensor communications national line	No.0	No.0-8
	Express each CH	OFF	OFF/ON
	Time setting for each CH	0'	0'-23h59

* Please refer to page 12 for the scope of each channel time setting (Time setting)

12 Output specifications

Temperature control output

In case of Door open or close /1st phase control

- Example of setting Open 1 temperature (Temperature setting: 30.0°C, Difference: 5.0°C)

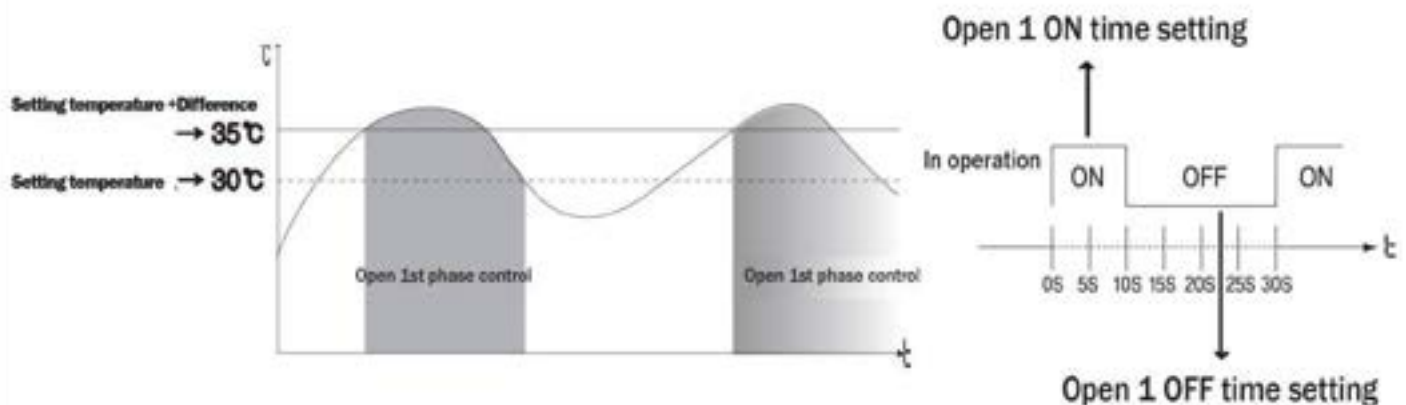

-Example of setting Close 1 Temperature (Temperature setting: -10.0°C , Difference: 5.0°C)

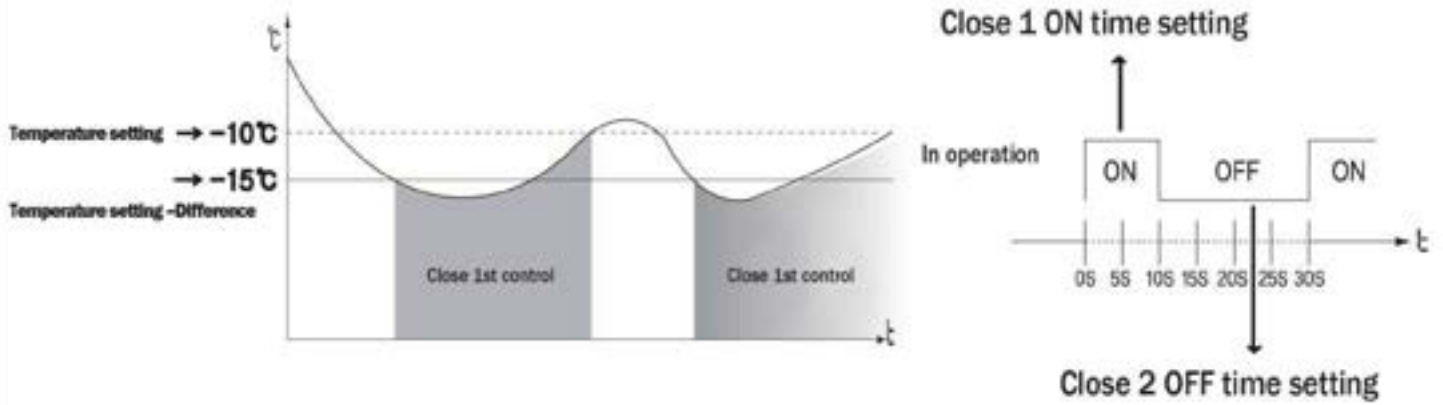

* In case of Door open or close control / 2nd phase control

- Example of open 2 temperature difference (Temperature setting: 10.0°C , Difference: 5.0°C , Open 2 temperature difference: 20.0°C)

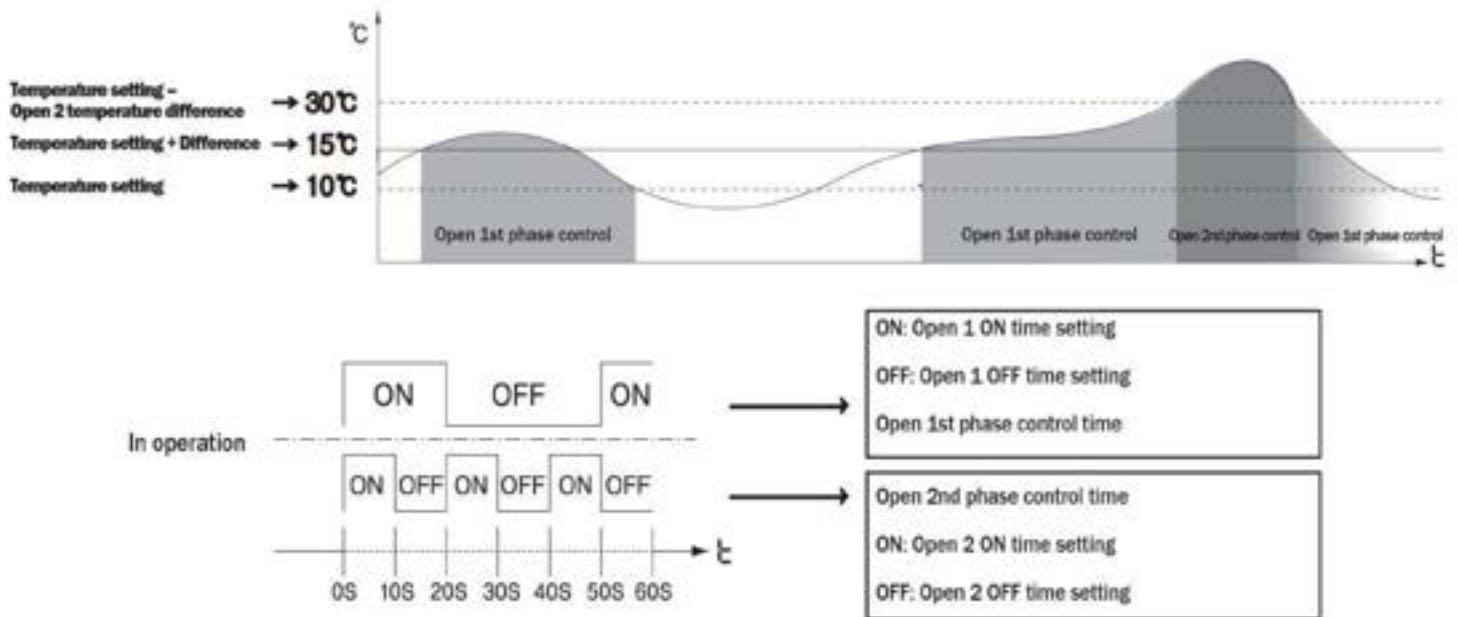

-Example of Close 2 temperature difference

(Temperature setting: -10.0°C , Difference: 5.0°C , Close 2 temperature difference: -10.0°C)

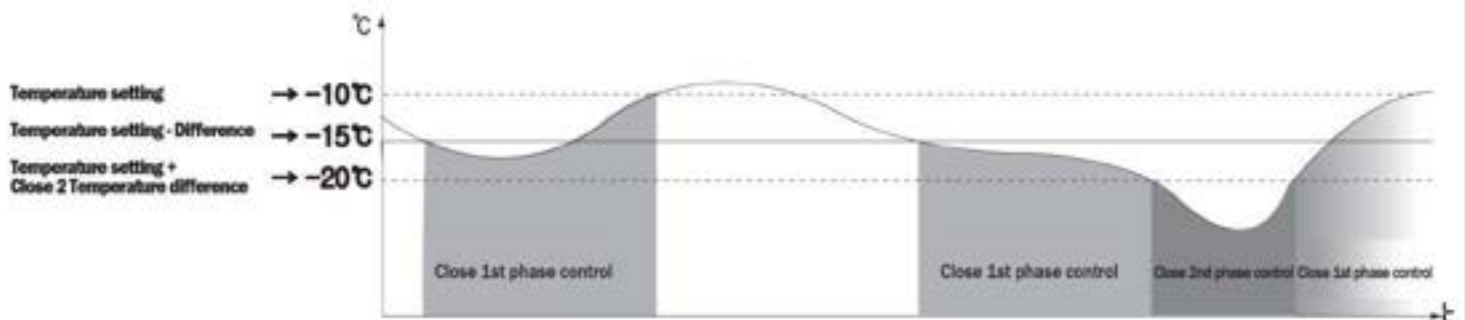

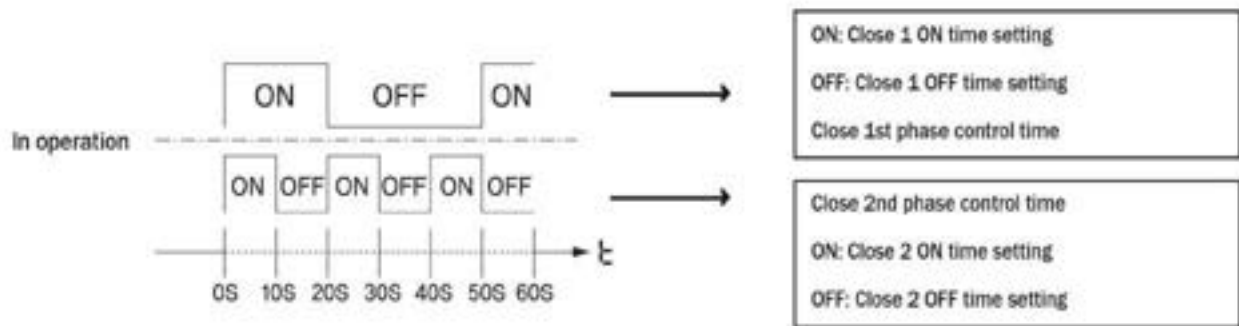

***In case of controlling temperature**

-Example of heater/cooler setting (Temperature setting: 10.0°C, Difference: 5.0°C)

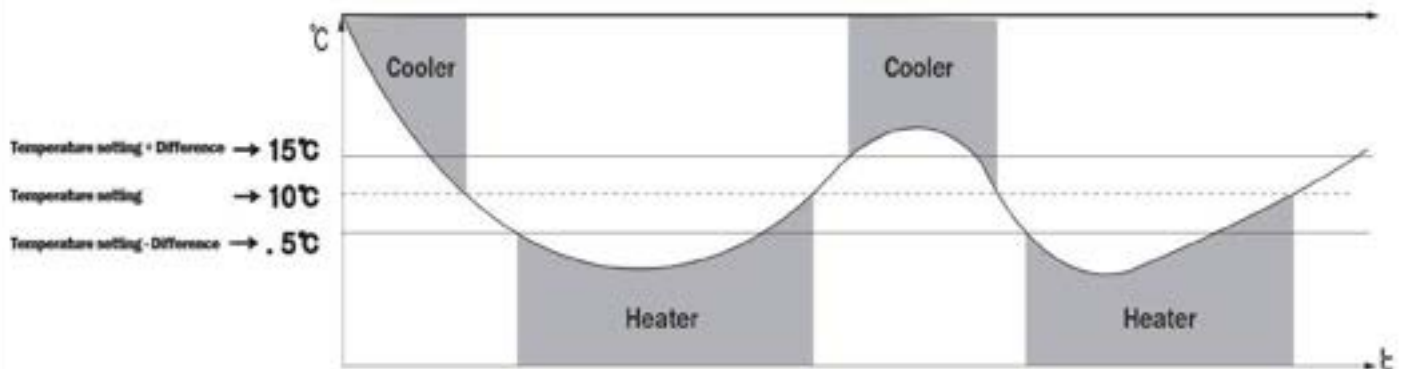

* Mushroom/Plant cultivation controls temperature by channel time.

* Indoor Air cleaning controls temperature not by channel time

CO2 Control Output

* In case of activating Illumination selection

-Output: Example of setting CO2 supply

(CO2 setting in sunny day: 1000ppm, CO2 setting in cloudy day: 500ppm, Difference: 1000ppm)

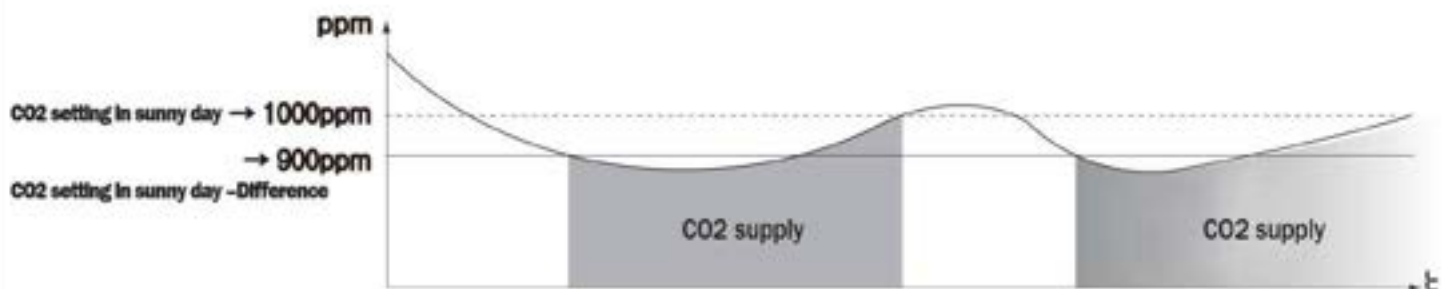

* Illumination >= Illumination setting in sunny day



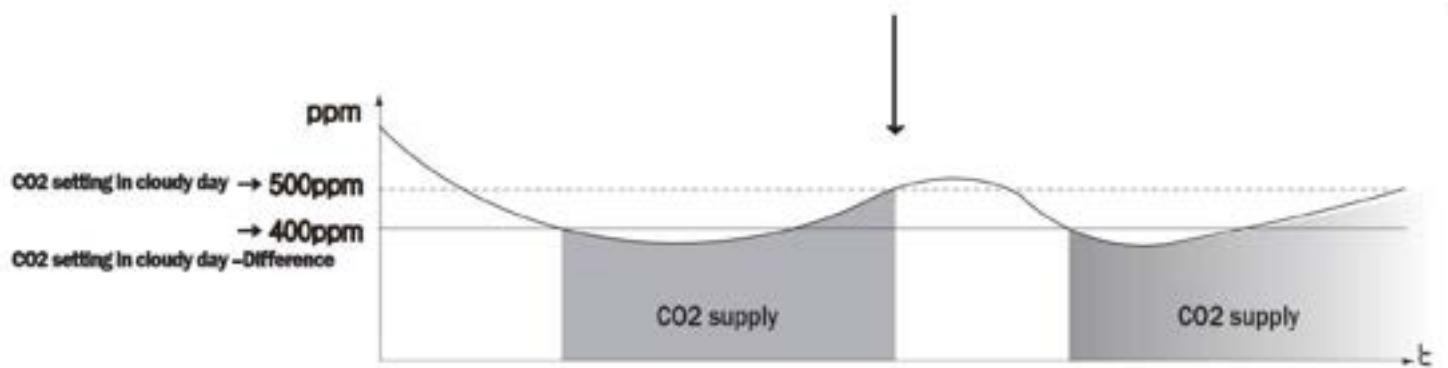

*Illumination setting in sunny day > Illumination >= Illumination setting in cloudy day
-If the illumination value does not affect the illumination setting value, the output will be off.

-Output: Example of setting FAN

(CO2 setting in sunny day: 1000ppm, CO2 setting in cloudy day: 500ppm, Difference 100ppm)

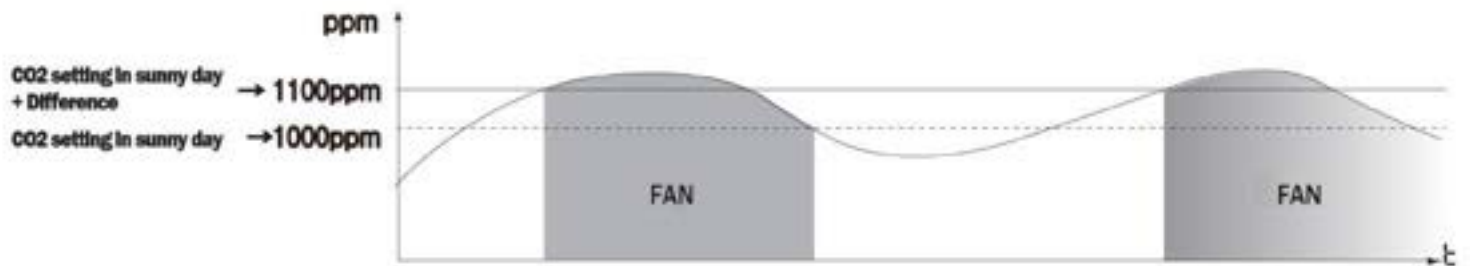

*Illumination >= Illumination setting in sunny day

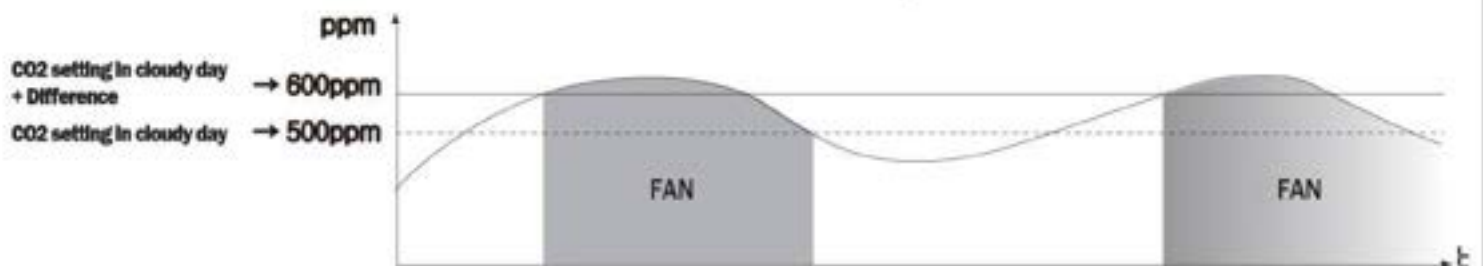

* Illumination setting in sunny day > Illumination >= Illumination setting in cloudy day
If the illumination value does not affect the illumination setting value, the output will be OFF

Humidity control output

Example of humidity setting (Humidity setting: 30%, Difference: Difference: 10%)

* In case of choosing Humidification

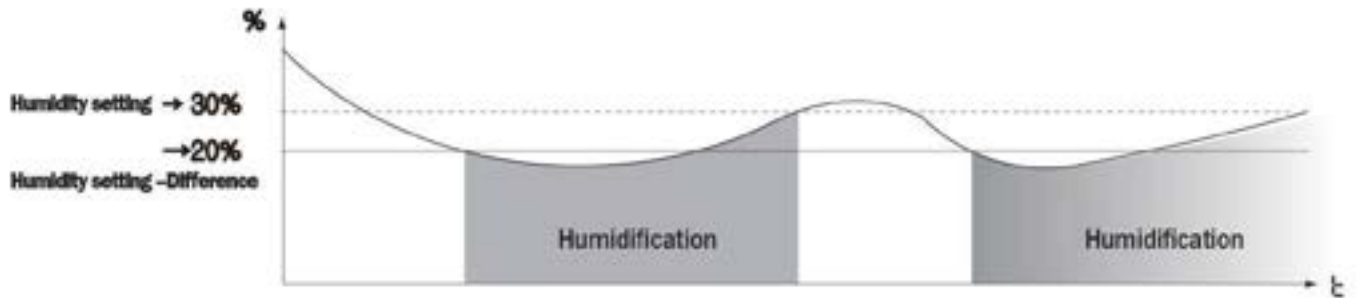

* In case of choosing Dehumidification

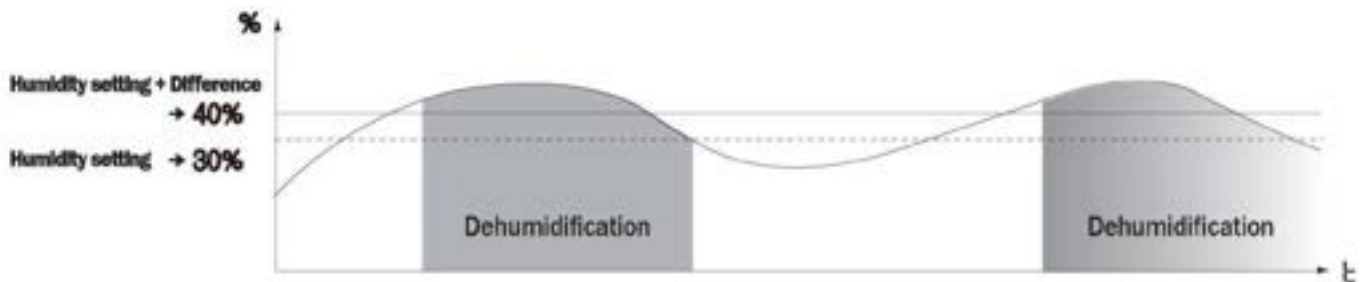

* Mushroom/Plant Cultivation sets humidity by channel time.

* Indoor Air Cleaning sets humidity not by channel time

Communications control output

■ Interface

Applied standard	In accordance with EIA RS485
Maximum connections	32 (However, Communications line can be se from 1 to 99.)
Communication measure	Two wire half duplex
Communication method	asynchronous
Communication range	Within 1.2Km
Communication speed	1200/2400/4800/9600/19200bps (Optional)
(Start Bit)	Start Bit, Fix 1bit
(Stop Bit)	Stop Bit, Fix 1bit
(Parity Bit)	Parity Bit, N/A
(Data Bit)	Data Bit, Fix 8bit
(Protocol)	Modbus RTU

System composition

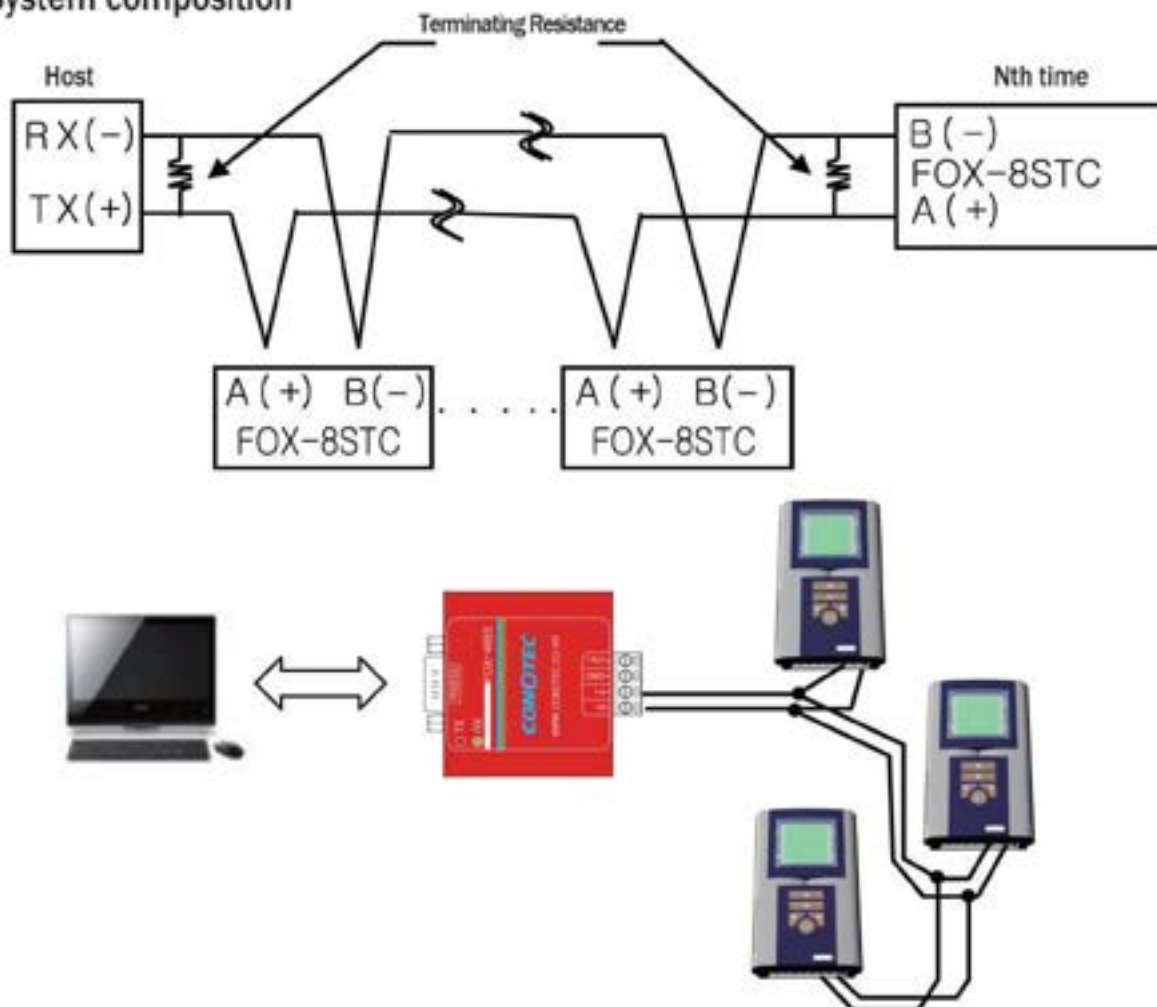

There is "RS485" for 1:N communication which uses RS 485 communications standard. At this time, the device will be SLAVE device. To communicate with PC program, additional RS485 to 232 Converter is needed. (Shall be purchased additionally)

It is recommended to use Twist Pair line for the communication cable which is optimal to RS 485 communications.

Modbus RTU composition

1. FOX - Communication protocol of 8STC is Modbus RTU.
2. The slave will send a response when Query is transmitted from Master.

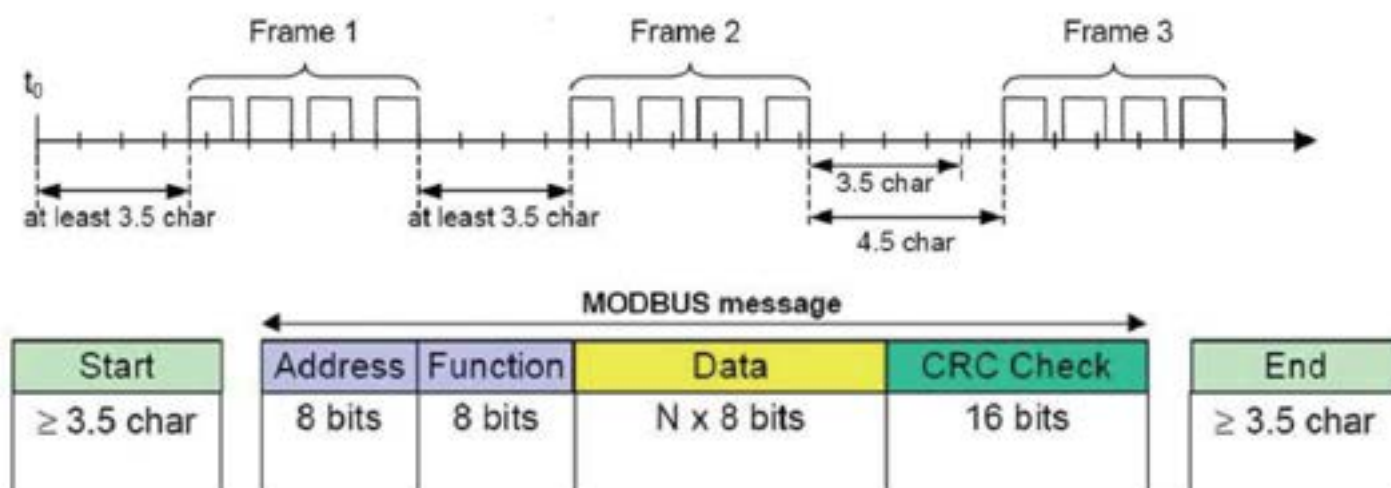

■ Definition of Communication Command and Block

<Format of Host Query>

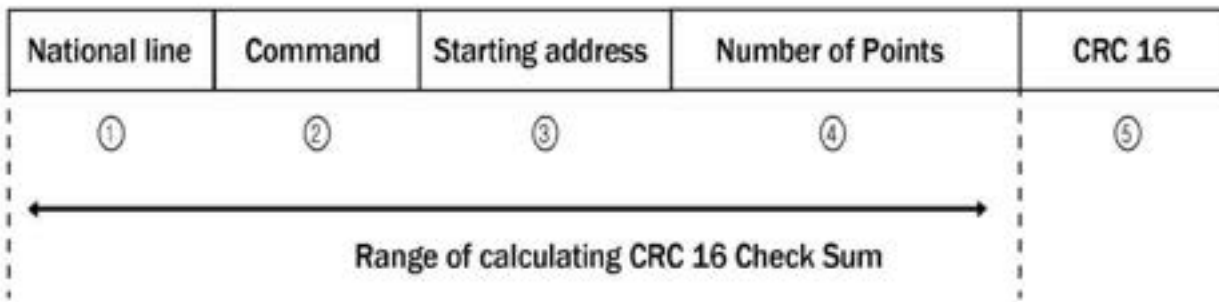

- ① National line: It is national line code that identifies 8STC by Master and it can be set from 1 to 99.
- ② Command: Command to read input register
- ③ Starting address: It is the starting address of input register that will be read.
- ④ Number of Points: Number of 16Bit Points that will be read from the starting address
- ⑤ CRC 16: It is a Code to guarantee a perfect transmission and reception of materials by checking errors that can be occurred in transmitting materials between transmitter and receiver and requesting re-transmission as a Check Sum that tests entire block.

< Format of FOX-8STC Response>

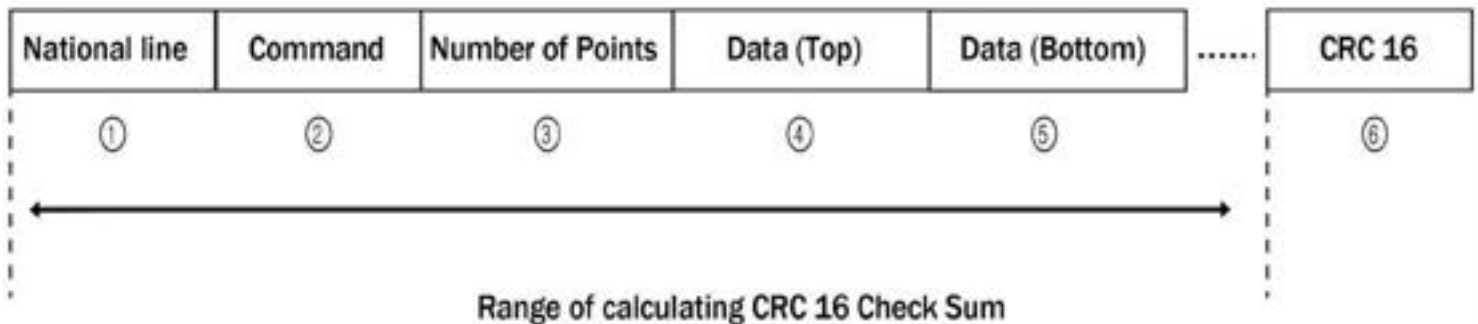

- ① National line: It is national line code that identifies 8STC by Master and it can be set from 1 to 99.
- ② Command: Command to read input register (Refer to Modbus Mapping Table)
- ③ Number of Points(Data): Number of 8Bit points(Data) that will be read from starting address. (Refer to Modbus Mapping Table)
- ④ Data (Top): Top data of read value (1Byte)
- ⑤ Data (Bottom): Bottom data of read value (1Byte)
- ⑥ CRC 16: It is Check Sum Code that tests entire block.

<Handle Error>

National line	Responding the command (Command)+80H	Exception code	CRC 16
---------------	--------------------------------------	----------------	--------

- Exception code:
- (01H) Unsupported command
 - (02H) Inconsistent between starting address of requested data and address that can be transmitted from the device
 - (03H) Inconsistent between requested number of points and the number that can be transmitted from the device
 - (04H) Can-not-handle the requested command

■ Modbus Mapping Table

<Read Discrete Inputs(Func02)>

NO	Address	Index	Scope of setting	Unit	Remarks
100001	0000	Open/Cooler	0:OFF 1:ON		
100002	0001	Close/Heater	0:OFF 1:ON		
100003	0002	Humidification/ Dehumidification	0:OFF 1:ON		
100004	0003	Supply CO2	0:OFF 1:ON		
100005	0004	Fan	0:OFF 1:ON		
100006	0005	Boozer	0:OFF 1:ON		

<Read Input Registers(Func04)>

NO	Address	Index	Scope of setting	Unit	Remarks
300001	0000	Temperature measurement	-20.0 ~ 65.0	℃	
300002	0001	Humidity measurement	0.0 ~ 100.0	%	
300003	0002	CO2 measurement	0 ~ 5000	ppm	
300004	0003	Illumination measurement	1 ~ 54600	Lux	
300005	0004	Express an error	0: Normal, 1: Disconnected		
300006	0005	LCD check box	0: P 1-9: number, 10: A 11: E		P: Mushroom/plant cultivation 1-9: Express a channel A: Indoor Air Cleaning E: Error in disconnected sensor
300007	0006	Open/Cooler (LCD output express)	0:OFF 1:ON		Bit0
		Close/Heater (LCD output express)	0:OFF 1:ON		Bit1
		Humidification/Dehumidification (LCD output express)	0:OFF 1:ON		Bit2
		CO2 supply (LCD output express)	0:OFF 1:ON		Bit3
		Fan (LCD output express)	0:OFF 1:ON		Bit4
		Boozer (LCD output express)	0:OFF 1:ON		Bit5
		Humidification/Dehumidification (Choose output expression)	0 : Humidification 1: Dehumidification		Bit6
		Temperature/Door open or close (Choose output expression)	0 : Cooler/Heater 1 : Open/Close		Bit7

<Read Holding Register(Func03)/Write Single Register(Func06)/Write Multiple Register(Func16)>

<Setting group related to temperature [Func: 03/06/16, RW: R/W]>

NO	Address	Index	Scope of setting	Unit
400001	0000	Choose an operation	1: Temperature control, 2: Door open/close control	
400002	0001	Door open/close control	1: 1st phase, 2: 2nd phase	
400003	0002	Temperature difference	1~199:0.1~19.9	℃
400004	0003	Correct temperature	-100~+100:-10.0~+10.0	℃
400005	0004	Output delay time	0~9	Minute
400006	0005		0~59	Second
400007	0006	Open 1 ON time	0~29	Minute
400008	0007		0~59	Second
400009	0008	Open 1 OFF time	0~29	Minute
400010	0009		0~59	Second
400011	000A	Close 1 ON time	0~29	Minute
400012	000B		0~59	Second
400013	000C	Close 1 OFF time	0~29	Minute
400014	000D		0~59	Second
400015	000E	Open 2 ON time	0~29	Minute
400016	000F		0~59	Second
400017	0010	Open 2 OFF time	0~29	Minute
400018	0011		0~59	Second
400019	0012	Close 2 ON time	0~29	Minute
400020	0013		0~59	Second
400021	0014	Close 2 OFF time	0~29	Minute
400022	0015		0~59	Second
400023	0016	Warning in temperature upper limit	Temperature lower limit x 10~650 : Temperature lower limit - 65.0	℃
400024	0017	Warning in temperature lower limit	-200~Temperature upper limit x 10: -20.0~Temperature upper limit	℃

NO	Address	Index	Scope of setting	Unit
400025	0018	Difference in Temperature warning	1~199:0.1~19.9	℃
400026	0019	Temperature setting	-200~650:-20.0~65.0	℃
400027 ~400035	001A ~0022	Open 1 temperature setting for each CH	Close 1 temperature setting for each CH x 10~650: Close 1 temperature setting for each CH~65.0	℃
400036 ~400044	0023 ~002B	Close 1 temperature setting for each CH	-200~Open 1 temperature setting for each CH x 10: -20.0~Open 1 temperature setting for each CH	℃
400045 ~40053	002C ~0034	Open 2 temperature difference of each CH	1~650:0.1~65.0	℃
400054 ~400062	0035 ~003D	Close 2 temperature difference of each CH	-200~-1:-20.0~-0.1	℃

<Setting group related to Humidity) [Func:03/06/16, RW:R/W]>

NO	Address	Index	Scope of setting	Unit
401001	03E8	Choose Humidification/ Dehumidification	1: Humidification, 2: Dehumidification	
401002	03E9	Output delay time	0~9	Minute
401003	03EA		0~59	Second
401004	03EB	Humidity difference	1~199:0.1~19.9	%
401006	03EC	Correct humidity	-100~+100:-10.0~+10.0	%
401007	03ED	Warning in humidity upper limit	Humidity lower limit x 10~1000: Humidity lower limit~100.0	%
401008	03EE	Warning in humidity lower limit	0~Humidity upper limit x 10: 0.0~Humidity upper limit	%
401009	03EF	Difference in humidity warning	1~199:0.1~19.9	%
401010	03F0	Humidity setting	0~1000:0.0~100.0	%
401011 ~401018	03F1 ~03F9	Humidity setting for each CH	0~1000:0.0~100.0	%

<Setting group related to CO2 [Func:03/06/16, RW:R/W]>

NO	Address	Index	Scope of setting	Unit
402001	07D0	Output delay time	0~9	Minute
402002	07D1		0~59	Second
402003	07D2	CO2 difference	10~1990	ppm
402004	07D3	Correct CO2	-500~+500	ppm
402005	07D4	Warning in CO2 upper limit	CO2 upper limit-5000	ppm
402006	07D5	Warning in CO2 lower limit	0~CO2 upper limit	ppm
402007	07D6	Difference in CO2 warning	10~1990	ppm
402008	07D7	CO2 setting	0~5000	ppm
402009 ~402017	07D8 ~07E0	CO2 setting of each CH in sunny day	0~5000	ppm
402018 ~402026	07E1 ~07E9	CO2 setting of each CH in cloudy day	0~5000	ppm
402027 ~402035	07EA ~07F2	Choose CO2 output of each CH	1: OFF, 2: CO2 supply, 3: Fan	ppm

<Setting group related to Illumination, [Func:03/06/16, RW:R/W]>

NO	Address	Index	Scope of setting	Unit
403001	0BB8	Choose illumination	1:OFF 2:ON	
403002	0BB9	Illumination setting in sunny day	Illumination setting in cloudy day~54600	Lux
403003	0BBA	Illumination setting in cloudy day	10~Illumination setting in sunny day	Lux

<Setting group related to others [Func:03/06/16, RW:R/W]>

NO	Address	Index	Scope of setting	Unit
404001	0FA0	Choose system	1: Indoor Air Cleaning, 2: Mushroom/Plant Cultivation	
404002	0FA1	Warning time	0~59	Minute
404003	0FA2		0~59	Second
404004	0FA3	Current time	0~23	Hour
404005	0FA4		0~59	Minute
404006	0FA5	485 communications National line	1~99	NO
404007	0FA6	485 Communications speed	1:1200 2:2400 3:4800 4:9600 5:19200	bps
404008	0FA7	Sensor Communications National line	1~99	NO
404009 ~404017	0FA8 ~0FB0	Express each CH	1:OFF 2:ON	
404018 ~404035	0FB1 ~0FC2	Time setting of each CH	0~23	Hour
			0~59	Minute

* The time setting scope of each CH is P12. (Refer to the time setting)

■ Composition of 300007(0006) Address Bit Data,(p42)

Bit7	Bit6	Bit5	Bit4	Bit3	Bit2	Bit1	Bit0
Temperature/ Door open or close	Humidification/ Dehumidification	Warning output	Fan output	CO2 supply output	Humidification/ Dehumidification output	Close/Heater output	Open/Cooler output
0 or 1	0 or 1	0 or 1	0 or 1	0 or 1	0 or 1	0 or 1	0 or 1
Bottom 1 Byte							

BitF	BitE	BitD	BitC	BitB	BitA	Bit9	Bit8
-	-	-	-	-	-	-	-
0	0	0	0	0	0	0	0
Top 1 Byte							

13 FS-600R



*Character

- Send values of CO₂, temperature, humidity and illumination sensors (RS-485)
- It installs NDIR CO₂ sensor based on Dual sensor so there is no need of rearrangement for a long time.
- It uses a special filter to prevent liquid or various pollutants but let gas or water vapor move freely at the same time. So, errors on CO₂ sensor are reduced.
- It is wall-mounting type. Please refer to the cautions in installing the sensor for the direction of installation.

Cautions in installing the sensor



The Illumination sensor is installed on FS-600R so the sensor side shall be located in upper side and it is recommended to place it in a place where the illumination volume is properly measured.

There will be a difference in measuring when placing the sensor in a place that is unfavorable to measuring illumination or a shadow.

1



2



3



4



1. FS-600R shall be placed in a direction of 0(No.1) mark.
2. Power supply shall be guaranteed in using.
3. If the installation direction is wrong or the power supply is disconnected in using, the inside of the product is humid: it can be a cause of product malfunction and there will be a problem in measuring illumination.
4. If the power supply shall be stopped, it is recommended to store the product in which there is no dew condensation because of zero humidity.
5. Please keep in mind that we do not take any responsibility for the problems due to wrong installation or reckless in storing the product.

Cautions in using the product

Thank you for choosing the product of CONOTEC. This product (FS-600R) installs special filters on both sides to measure CO₂. Please note that if there is a default due to user's carelessness like tear or push, the user will cover the cost.

In addition, do not open the product: even though this product has water-proof structure in accordance with IP67, it can be humid when the user opens the product. In that case, the user shall cover the cost for the default.

Sensor Wiring Diagram

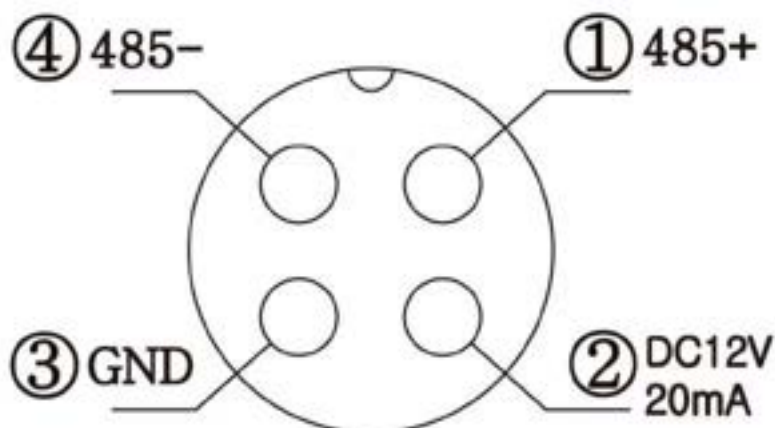

Character of sensors

<Temperature Sensor>

Item	Contents	Remarks
Measuring range	-20.0 ~ 65.0℃	
Resolution	0.01 ℃	
Repeat correctness	±0.1 ℃	
Respond time	(Min) 5 ~ (Max) 30 Sec	

<Humidity Sensor>

Item	Contents	Remarks
Measuring range	0 ~ 100 %RH	
Resolution	0.03 %RH	
Repeat correctness	±0.1 %RH	
Respond time	4 Sec	

<Illumination Sensor>

Item	Contents	Remarks
Measuring range	0 ~ 54600 Lux	
Resolution	32 Lux	
Measuring correctness	0.75 ~ 1.65 Times	
Respond time	(Min) 2.9 ~ (Max) 4.5 ms	

<CO2 Sensor>

Item	Contents	Remarks
Measuring method	NDIR method	
Measuring range	0 ~ 5000 ppm	
Degree of precision	±2 %	@ 10 ~ 50 ℃
Respond time	0 ~ 80 % < 30 Sec	
Intervals between updating the signal	Every 2.0 Seconds	
Warm-up Time	@ 25 ℃ < 90 Sec	
Operation conditions of Temperature/Humidity	0 ~ 50℃, 0 ~ 95% RH	
Storage temperature	-40 ~ 70 ℃	

Communications Protocol

■ Format of requesting data

Byte	1	2	3	4	5	6	7	8	9	10
Contents	STX	ID	R	X	Z	T	H	L	ETX	BCC

■ Format of responding data

Byte	1	2	3	4	5	6	7	8	9	10
Contents	STX	ID	R	D	Z	CO2 Value				T

Byte	11	12	13	14	15	16	17	18	19	20
Contents	Temperature Value					H	Humidity Value			

Byte	21	22	23	24	25	26	27	28
Contents	L	Illumination Value				ETX	BCC	

*The contents of each item will be expressed in ASC11 format.

- STX: Start Code [02H]
- ID: Address Code, Terminal ID [30H-38H]
- RX: Reading Request R[52H], X[58H]
- ZTHL: Measurements of CO2, Temperature, Humidity and Illumination Z[5AH], T[54H], H[48H], L[4CH]
- CO2 Value: Express CO2 value Ex. 3000ppm: [33H], [30H], [30H], [30H]
- Temperature Value: Express temperature value
 In case of above zero, 11th Byte will be [31H]
 In case of below zero, 11th Byte will be [30H]
- Humidity Value: Express Humidity value
- Illumination Value: Express Illumination value
- ETX: End Code [03H]
- BCC: It means XOR operation value from first protocol (STX) to ETX as an abbreviation of Block Check Character.

Sensor Communications ID

8-pin Dip Switch ID Setting

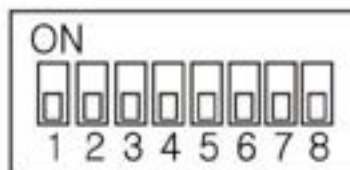

It will be set on ID 0 address and send data when there is data request.

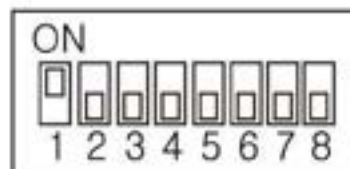

It will be set on ID 1 address and send data when there is data request.

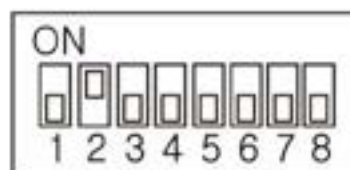

It will be set on ID 2 address and send data when there is data request.

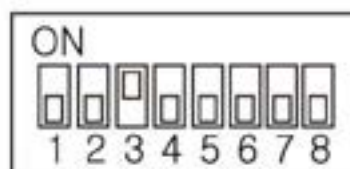

It will be set on ID 3 address and send data when there is data request.

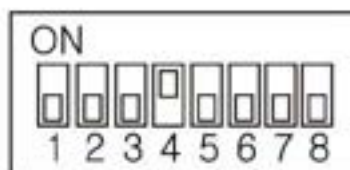

It will be set on ID 4 address and send data when there is data request.

•
•
•
•
•
•

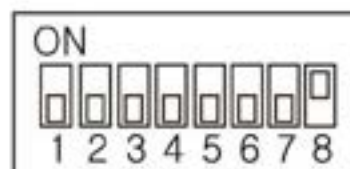

It will be set on ID 8 address and send data when there is data request.

Size of the sensor case

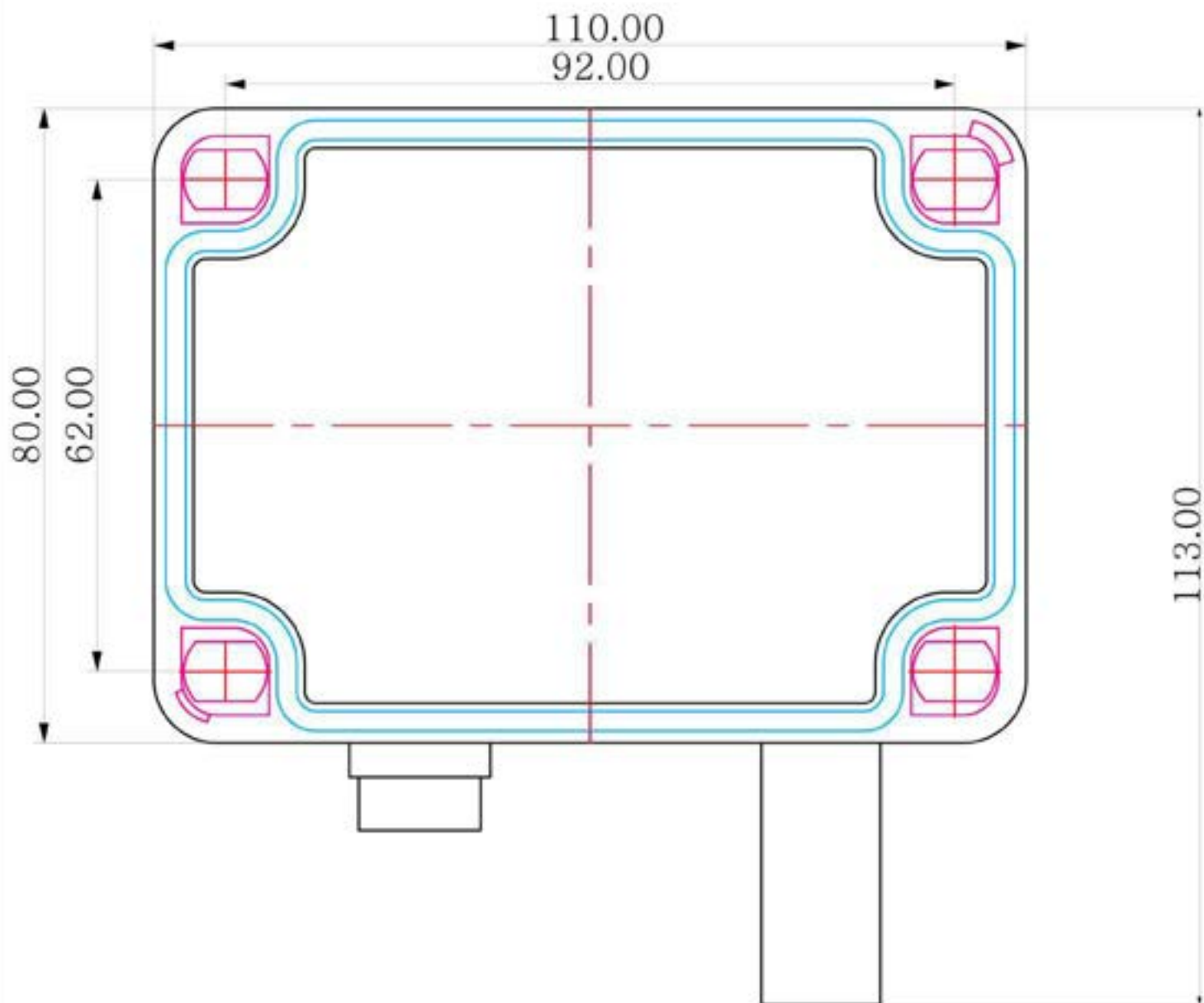

Product Warranty

This product was manufactured after undergoing strict quality management and tests of CONOTEC Inc. The warranty period of this product will be one year after purchase in accordance with the Consumer Injury Compensation Rule. So, please certainly write down the purchasing date and place at the place where the product is purchased.

If the user is failed to write down the information, the warranty will be one year and six months since the release date.

Product Name	
Model Name:	
Purchasing Date	YYYY MM DD
Purchasing Place	

Please prepare this Product Warranty when there is a default in manufacturing or natural malfunction within the period of Product Warranty and visit the purchasing place of main office of CONOTEC for the free repair.

Repair cost can be charged for the following cases or the Warranty period is passed.

- Please be sure to read this manual instruction. If a user requests After Service and the product has no problem, certain cost will be charged.
- In case of malfunction due to carelessness of a user or that a user fixes or remodels the product arbitrarily
- In case of malfunction due to wrong electric capacity
- In case of malfunction due to shocks like fallings
- In case that a user does not abide by this manual instruction
- In case of malfunction due to natural disasters (Fire, Flood damage, Earthquake, Lighting, etc.)

A/S center

- Purchasing place
- A/S Department under CONOTEC Quality Management Division : T: 070-7815-8266, F: 051-819-4562

MEMO



This instruction includes ownership information protected by the Copyright.
All rights will be owned by the Copyright owner. This instruction must not be copied, manufactured or translated into other languages without CONOTEC's approval signature.
Reporting Date: June 5, 2015 Manual Version: V1.0