

Operating Manual



1 Caution

※ Safety and Hazard Instructions

⚠ Safety

Please use this item after installing the duplex safety device in which is applied at dangerous factors such as serious human injury or damages of property & important machine because this item is not designed as safety device

⚠ Safety Instruction and Hazard Warnings

- Please read the operating manual carefully before putting the device into operation.
- We will not assume any responsibility for damage to assets or persons caused by improper handling or failure to observe the safety instructions or hazard warnings.
- For safety and licensing reasons, unauthorized conversion and/or modification of the device is not permitted.
- Do not exceed the maximum permissible current – in case of higher loads, use a contactor of adequate power. Make sure that the supplied voltage matches the values specified for the instrument.
- The device must be adequately protected from water and dust as per the application and must be accessible via the use of appropriate tools.
- The device must not be exposed to extreme temperature, sunlight, strong vibrations or high levels of humidity.
- Operation or installation is not permitted under unfavorable ambient conditions such as wetness or excessive induction loads or solenoid and dust, combustible gases, vapors or solvents, especially high-frequency noise.
- Avoid operation or installation close to high-frequency fields such as welding devices, sewing machines, wireless transmitter, radio systems, SCR controller, etc.
- Do not install the sensor cable nearby signal cable, power cable, load cable.
- Please use the shield cable when the sensor cable's lengthened, however do not make it too much longer.
- Please use the sensor cable without any cutting or flaw, blemish.
- The device is not a toy and should be kept away from children.
- Installation work must only be carried out by suitably qualified personnel who are familiar with the hazards involved and with the relevant regulations.
- You shouldn't tinker with anything or the product may not be opened or disassembled unless you know what you're doing.
- Please ask us about this questioning.

⚠ Danger

- Hazard related to electric shock
 1. Electric shock – Do not touch the AC terminal while current is flowing. It may cause electric shock.
 2. Disconnect the input power before checking the input power.

2 Digital Panel Meter

1. FOX-M200 & 2PT-1 & 2CA-2

Model	FOX-M200	FM-2PT-1	FM-2CA-2
Sensor	NTC(10K)	PT100Ω	CA(K)
Temp.range	-55.0 ~ 99.9℃	-199.9 ~ 400℃	-50 ~ 1200℃
Power Supply	230VAC 50/60Hz		100~240 50/60Hz
Power consumption	Maximum : 1.5VA		
Ambient Temp/Humi	0 ~ 55℃ 35 ~ 80%RH		
Storage Temp.	-10 ~ 70℃		
Correction of Temp.	- If you take off the front cover and use of up/down key, you can use the correction function for temperature. (M200 : left key = up, right key = down) - Return at corrected temperature automatically after 5 seconds.		
Display height	12.4mm		
Size	72mm X 36mm		

2. FOX-PM series & CM series

Model	FOX-PM5000(T) FOX-PM5101(T)	FOX-PM6000(T) FOX-PM6101(T)	FOX-CM5000 FOX-CM5000T
Sensor	PT100Ω	NTC(10K)	CA(K)
Temp.range	-50 ~ 400℃	-55 ~ 99.9℃	0 ~ 1200℃
Waterproof	Waterproof		Non-waterproof
Power Supply	Please use the power supply only 12V AC/DC (electric current = over 150mA) If you use a special power supply, please use the adaptor. (When deliver = 12V DC) - Specification for Adaptor : 12V AC/DC output minimum electric current = 150mA - If the adaptor is not used, it may cause a fire or out of order. - When sensor wire lengthened(PM series) → Pls use the 3P cable. - When sensor wire lengthened(CM series) → Pls use the thermo couple cable. ※ If you use it over 85℃, you have to use a special sensor.		
Ambient Temp/Humi	0 ~ 70℃ 35 ~ 100%RH		
Storage Temp.	-10 ~ 70℃		
Display height	56.8mm		
Correction of Temp.	After taking off the back panel, on the basis of white wire, Short-circuit white and red : increased by 1℃ white and black : reduced by 1℃ (But, PM 6000 series are increased/reduced by 0.1℃.)		
Maximum correction	±30℃	±10℃	±50℃
Material and Type	stainless	Wall-mounted	PM5000, PM6000, CM5000
		Stand type	PM5000T, PM6000T, CM5000T
	acryl, wall-mounted	one side	PM5101, PM6101
		both side	
	acryl, stand type	one side	PM5101T, PM6101T
		both side	

3. FM-5N & FM-5P & FM-5C

Model	FM-5N	FM-5P	FM-5C
Sensor	NTC(10K)	PT100Ω	CA(K)
Temp.range	-55.0 ~ 99.9℃	-199.9 ~ 400℃	-50 ~ 1200℃
Power Supply	100 ~ 240 VAC 50/60Hz		
Ambient Temp/Humi	0 ~ 55℃ 35 ~ 80%RH		
Storage Temp.	-10 ~ 70℃		
Correction of Temp.	Rear terminal – UP Key : 13,14 – Down Key : 13,15		
Display height	20.3mm		
Size	96mm x 48mm		

3 Connection

■ FOX-M200 & FM-2PT-1 & FM-2CA-2

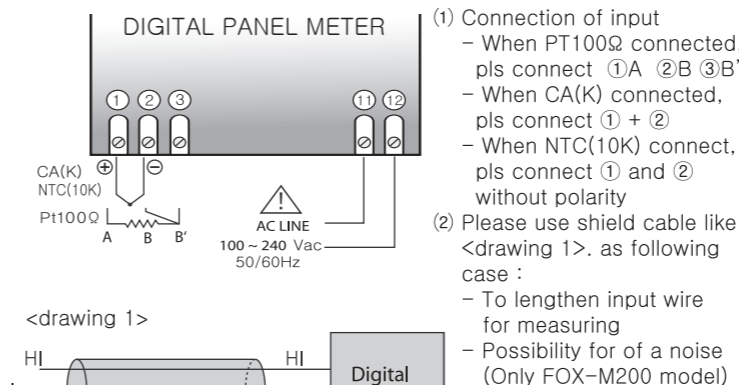

■ FM-5P & FM-5C & FM-5N

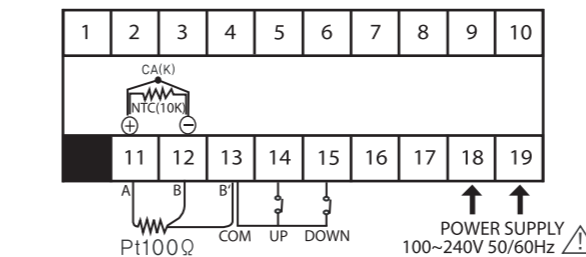

■ FOX-PM series

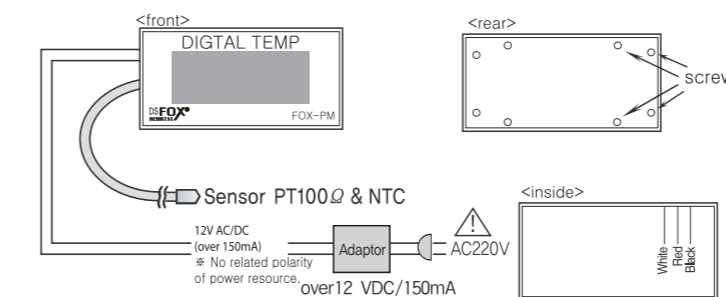

■ FOX-CM series

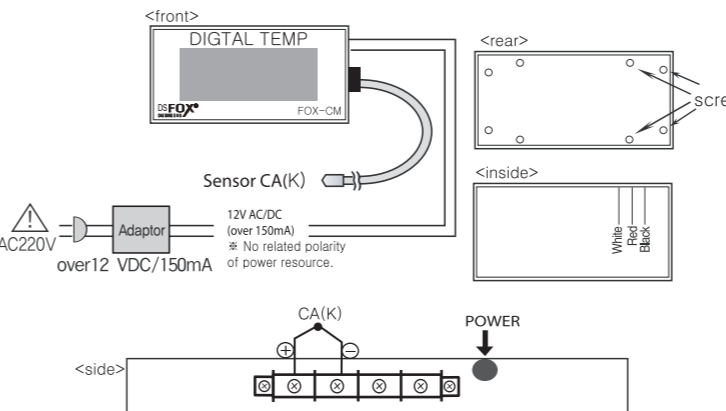

4 Dimension

■ FOX-M200 & FM-2PT-1 & FM-2CA-2

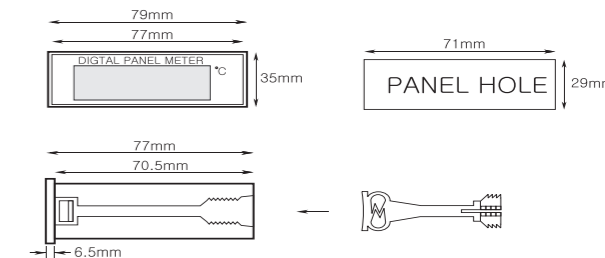

■ FOX-PM series & FOX-CM series

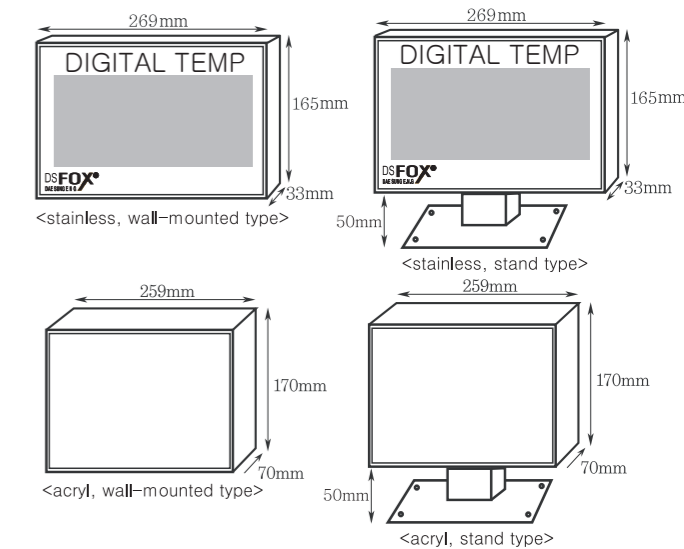

■ FM-5P & FM-5C & FM-5N

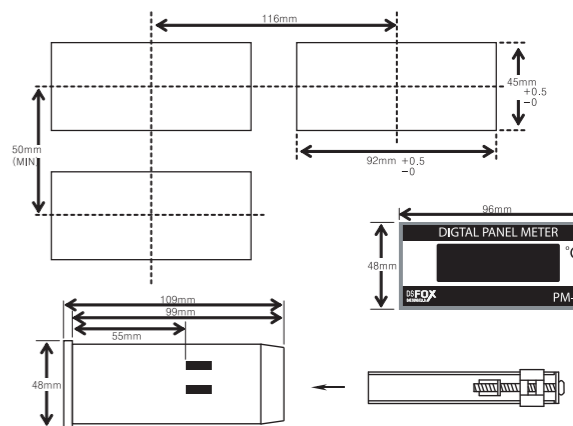

5 Simple troubleshooting tip

■ If displaying ERROR while using the product:

- If **E₁** is displayed when DATA memory elements inside are damaged due to powerful noise from outside while using the product. In such a case, contact our company for customer service. Despite the controller is provided with supplementary measures for outside noise, it cannot endure infinite noise. Noise (2KV) abnormality may damage inside of the unit.
- If **E₂** or **E₃** messages appear, the sensor is defective. Please check the sensor.

※ This device's specification can be changed without any notification to improve its quality

■ H.Office : Ballyonsandan 1-ro, Jangan-eup, Gijang, Busan, Republic of Korea
 ■ Factory : Ballyonsandan 1-ro, Jangan-eup, Gijang, Busan, Republic of Korea
 ■ TEL : +82 (051) 819-0425~7
 ■ FAX : 82-51-819-4562

■ E-mail : conotec@conotec.co.kr
 ■ Homepage : www.conotec.co.kr

■ Main Products & Development
 - Digital Temperature /Humidity Controller
 - Digital Timer, Current/Voltage Meter
 - Other Products Development