

# Shihlin Electric General Inverters

## SE3 Series

### User Manual

---

#### *High Functioning & High Performance*

SE3-021-0.4K ~ 2.2K    SE3-023-0.4K ~ 15K

SE3-043-0.4K ~ 22K

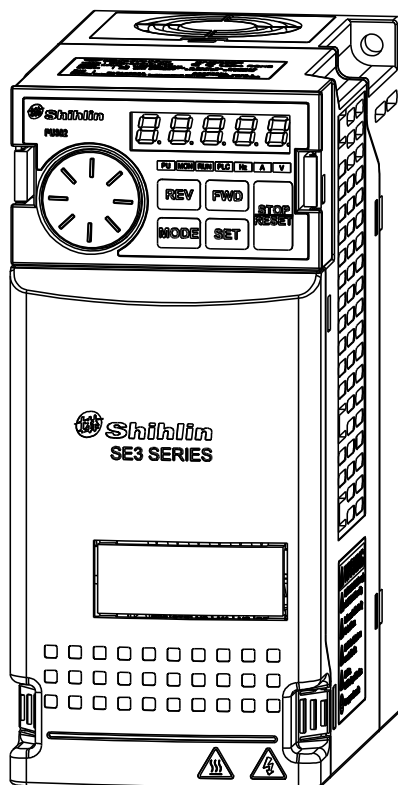

MANUAL GUIDE	1
DELIVERY CHECK	2
INVERTER INTRODUCTION	3
BASIC OPERATION	4
PARAMETER DESCRIPTION	5
INSPECTION AND MAINTENANCE	6
APPENDIX	7



# 1. MANUAL GUIDE

## 1.1 Safety instructions

Thank you for choosing Shihlin inverters SE3 series. This user manual introduces how to use the product correctly. Please read the user manual carefully before using the product. In addition, please use the product after understanding the safety instructions.

### Safety Instructions

- ✓ **Installation, operation, maintenance and inspection must be performed by qualified personnel.**
- ✓ **In this instruction, the safety instruction levels are classified into "Warning" and "Caution".**
  - ⚠ **Warning: Incorrect handling may cause hazardous conditions, resulting in death or severe injury.**
  - ⚠ **Caution: Incorrect handling may cause hazardous conditions, resulting in medium or slight injury, or may cause only material damage.**

#### ⚠ Warning

- ✓ While the inverter power is ON, do not open the front cover or the wiring cover. Do not run the inverter with the front cover or the wiring cover removed. Otherwise you may access the exposed high voltage terminals or the charging part of the circuitry and get an electric shock.
- ✓ It is crucial to turn off the motor drive power before any wiring installation or inspection is made. Before the inverter CHARGE light is OFF, which indicates that there is still high voltage in it, please do not touch the internal circuit and components. Operation must be made after measuring the voltage which is less than 24 VDC between + /P and - /N and with avometer.
- ✓ The inverter must be connected to the ground properly.
- ✓ Do not operate or touch the heat sink or handle the cables with wet hands. Otherwise you may get an electric shock.
- ✓ Do not change the cooling fan while power is ON. It is dangerous to change the cooling fan while power is ON.

#### ⚠ Caution

- ✓ Voltage applied to each terminal must be the one specified in the user manual; otherwise, failure or damage may be caused.
- ✓ Do not operate a voltage-resistant test for the parts inside the inverter because semiconductors in inverter may be easily damaged due to high-voltage breakdown.
- ✓ Do not touch the inverter because the temperature of the inverter is very high when it is powered on or right after disconnecting the power supply; otherwise, burn may occur.
- ✓ Failure or damage may be caused due to wrong wiring.
- ✓ Do not reverse the polarities (+, -) by mistake, failure or damage may be caused.
- ✓ Please install the inverter on nonflammable walls without holes (to avoid contacts with the cooling fin of the inverter from the back). If the inverter is installed on or close to flammable objects it may cause a fire.
- ✓ Please disconnect the inverter from power supply in case of failure. Overload current passes through the inverter continuously may cause a fire.
- ✓ Do not connect a resistor on DC terminals +/P and -/N directly; otherwise it may cause fire.

#### Other Precautions:

\*1 If the product is ultimately used as a military unit, or when the product is used for weapons manufacturing, etc., this product will be included in the export product control object specified in the "Foreign Trade Law of PRC". When exporting, strict inspection and export procedures are required.

\*2 In this manual, the case or the safety cover will be remove, and the description will be made in graphics and text in order to explain the product in detail. When operating, to ensure safety be sure to install the case and wire correctly according to the regulations referred in manual.

\*3 Graphics in the manual are slightly different from the actual product for the convenience of illustrating, this will not affect customer rights.

\*4 To improve our products, parameters and contents may be modified in the future, and the contents of this manual are subject to change without notice. Please download the latest version from Shihlin website ([www.ssec.com.cn](http://www.ssec.com.cn) or [www.seec.com.tw](http://www.seec.com.tw)).

## 1.2 Contents

User Manual .....	- 1 -
1. MANUAL GUIDE .....	1
1.1 Safety instructions.....	1
1.2 Contents .....	2
1.3 Definitions of terminologies.....	14
2. DELIVERY CHECK.....	15
2.1 Nameplate instruction.....	15
2.2 Type instruction .....	15
2.3 Order code description .....	15
3. INVERTER INTRODUCTION.....	16
3.1 Electric specification .....	16
3.1.1 440V series three-phase.....	16
3.1.3 220V series three-phase.....	18
3.2 General specification .....	19
3.3 Appearance and dimensions.....	21
3.3.1 Frame A.....	21
3.3.2 Frame B.....	22
3.3.3 Frame C.....	23
3.3.4 Frame D.....	24
3.4 Name of each component.....	25
3.4.1 Frame A/B/C/D .....	25
3.4.2 Protection level and operation temperature.....	25

---

3.5 Installation and wiring .....	26
3.5.1 Transportation .....	26
3.5.2 Stockpile .....	26
3.5.3 Installation notice .....	26
3.5.4 EMC installation instructions .....	28
3.5.5 Removing front cover .....	29
3.6 Peripheral devices.....	30
3.6.1 System Wire Arrangement .....	30
3.6.2 No-fuse breaker and magnetic contactor .....	31
3.6.3 Regenerative Brake Resistor .....	31
3.6.4 Reactor .....	33
3.6.5 Filter .....	35
3.7 Terminal wire arrangement.....	36
3.7.1 Main circuit Terminals .....	37
3.7.2 Main circuit wiring and terminal specification .....	39
3.7.3 Ground.....	40
3.7.4 RFI filter .....	40
3.7.5 Control circuit.....	41
3.8 Replacement procedure of fan.....	46
3.8.1 Frame A/B.....	46
3.8.2 Frame C/D.....	46
4. BASIC OPERATION .....	47
4.1 Component name of keypad (PU302) .....	47
4.2 Operation modes of inverter .....	49

4.2.1	Flow chart for switching operation mode.....	50
4.2.2	Flow chart for switching working mode with PU302 keypad .....	50
4.2.3	Operation flow charts for monitoring mode with PU302 keypad.....	50
4.2.4	Operation flow charts for frequency setting mode with PU302.....	51
4.2.5	Operation flow charts for parameter setting mode with PU302 .....	51
4.3	Basic operation steps for different modes.....	52
4.3.1	Basic operation steps for PU mode (00-16(P.79) = 0 or 1).....	52
4.3.2	Basic operation steps for external mode (00-16(P.79) = 0 or 2).....	52
4.3.3	Basic operation steps for JOG mode (00-16(P.79) = 0 or 1).....	53
4.3.4	Basic operation steps for communication mode (00-16(P.79) = 3) .....	53
4.3.5	Basic operation steps for combined mode 1 (00-16(P.79) = 4).....	53
4.3.6	Basic operation steps for combined mode 2 (00-16(P.79) = 5).....	54
4.3.7	Basic operation steps for combined mode 3(00-16(P.79) = 6).....	54
4.3.8	Basic operation steps for combined mode 4(00-16(P.79) = 7).....	55
4.3.9	Basic operation steps for combined mode 5(00-16(P.79) = 8).....	55
4.3.10	Basic operation procedures for the second operation mode(00-16(P.79) = 99999).....	55
4.4	Operation.....	56
4.4.1	Check and preparation before running .....	56
4.4.2	Running methods.....	56
4.4.3	Test run .....	57
5.	PARAMETER DESCRIPTION .....	58
5.1	System parameter group 00 .....	58
5.1.1	Inverter information.....	62
5.1.2	Parameter restoration.....	63

---

5.1.3 Parameter protection.....	65
5.1.4 Monitoring function .....	69
5.1.5 Speed display .....	70
5.1.6 PWM carrier frequency .....	70
5.1.7 Stop operation selection .....	71
5.1.8 Forward/reverse rotate prevent function .....	72
5.1.9 Operation mode selection.....	72
5.1.10 Control mode selection .....	73
5.1.11 Motor control mode selection.....	74
5.1.12 Motor types selection .....	75
5.1.13 50/60Hz switch selection .....	75
5.1.14 Parameter mode setting .....	76
5.1.15 Frequency mode setting .....	76
5.1.16 Expansion card type display .....	76
5.2 Basic parameter group 01.....	78
5.2.1 Limiting the output frequency .....	80
5.2.2 Base frequency, base voltage.....	80
5.2.3 Acceleration/deceleration time setting.....	81
5.2.4 Torque boost <b>V/F</b> .....	83
5.2.5 Starting frequency.....	84
5.2.6 Load pattern selection <b>V/F</b> .....	84
5.2.7 JOG run .....	87
5.2.8 Output frequency filter time .....	87
5.2.9 Frequency jump.....	88

5.2.10 Second function .....	89
5.2.11 Middle frequency, output voltage of middle frequency V/F .....	90
5.2.12 S pattern time .....	90
5.2.13 Remote Control Frequency Acc/Dec Time Selection .....	92
5.3 Analog input and output parameter group 02 .....	93
5.3.1 Analog input terminals and M2 terminal function selection .....	98
5.3.2 Analog output terminals AM function selection .....	99
5.3.3 Proportional linkage gain .....	100
5.3.4 Auxiliary frequency .....	101
5.3.5 Terminal 2-5 signal selection and processing .....	101
5.3.6 Terminal 4-5 signal selection and processing .....	107
5.3.7 Terminal HDI signal selection and processing .....	109
5.3.8 Terminal HDO clock multiplier factor .....	110
5.3.9 Terminal FM analog output function selection.....	111
5.3.10 Terminal AM signal selection and processing .....	111
5.3.11 Maximum analog output reference .....	113
5.3.12 Terminal AM/FM fixed output level .....	113
5.3.13 PT100 level setting.....	113
5.3.14 FM calibration parameter.....	114
5.4 Digital input/ output parameter group 03 .....	115
5.4.1 Digital input terminals function selection .....	119
5.4.2 Digital output terminals function selection.....	126
5.4.3 Terminal logic selection .....	127
5.4.4 Digital output signal delay.....	128



---

5.4.5 Digital input signal filter .....	128
5.4.6 Digital input terminal enable when power on .....	128
5.4.7 Output frequency detection .....	129
5.4.8 Zero current detection .....	130
5.4.9 Expanded digital input terminals function selection .....	130
5.4.10 Expanded digital input terminal logic selection .....	131
5.4.11 Expanded digital output terminal function selection .....	131
5.4.12 Digital input / output terminal monitor .....	132
5.5 Multi-speed parameter group 04 .....	133
5.5.1 16 steps speed .....	135
5.5.2 Programmed operation mode .....	137
5.6 Motor parameter group 05 .....	140
5.6.1 Motor parameter automatic measurement .....	142
5.6.2 Motor parameter .....	145
5.6.3 Automatic measurement of motor inertia .....	147
5.6.4 Second motor parameter .....	148
5.7 Protection parameter group 06 .....	150
5.7.1 Electronic thermal relay capacity .....	153
5.7.2 Current stalling protection .....	154
5.7.3 Regenerative brake .....	156
5.7.4 Decrease carrier protection setting .....	156
5.7.5 Over torque detection .....	158
5.7.6 Stall level when restart .....	159
5.7.7 Cooling fan operation .....	159

5.7.8 Input phase loss protection .....	160
5.7.9 Output short circuit protection function .....	160
5.7.10 PTC protection selection .....	160
5.7.11 Maintenance alarm function .....	161
5.7.12 Short circuit to ground protection .....	161
5.7.13 Output phase loss protection .....	162
5.7.14 Low voltage protection .....	162
5.7.15 Regenerative brake operation level .....	162
5.7.16 Voltage stall level .....	163
5.7.17 Capacitor lifetime detection .....	163
5.7.18 Time record function .....	164
5.7.19 Output power calculation .....	164
5.7.20 Alarm query function .....	165
5.7.21 Alarm code query .....	166
5.7.22 Latest alarm message (E1) .....	167
5.7.23 The second alarm message (E2) .....	167
5.8 Communication parameter group 07 .....	168
5.8.1 Shihlin protocol and Modbus protocol .....	171
5.8.2 Communication EEPROM write selection .....	187
5.8.3 CANopen protocol .....	188
5.8.4 Communication card version .....	188
5.8.5 Ethernet communication .....	189
5.9 PID parameter group 08 .....	190
5.9.1 PID function selection .....	192

---

5.9.2 PID parameter group 1.....	192
5.9.3 PID parameter group 2.....	197
5.9.4 PID filter setting.....	198
5.9.5 PID deviation control limit.....	198
5.9.6 PID integral property.....	199
5.9.7 PID differential limit.....	199
5.9.8 PID output deviation limit.....	199
5.9.9 PID parameter switchover.....	200
5.9.10 PID action when error occurs.....	200
5.9.11 PID reverse run operation selection.....	201
5.9.12 Pressure unit (Bar) setting.....	201
5.9.13 PID feedback disconnection detection function.....	202
5.10 PG feedback parameter group 09.....	203
5.10.1 PG type selection.....	204
5.10.2 PG1 parameter.....	205
5.10.3 PG error detection.....	206
5.10.4 PG2 parameter.....	207
5.10.5 Dividing frequency output function.....	208
5.10.6 Electronic gear ratio.....	208
5.10.7 Reverse spin detection.....	208
5.10.8 Expansion card version information.....	209
5.10.9 PG card Z phase correction margin Z.....	209
5.10.10 DV1/DV2 alarm of PG card Z phase.....	209
5.10.11 Encoder installation transmission ratio.....	210

5.11 Application parameter group 10.....	211
5.11.1 DC injection brake .....	215
5.11.2 Zero-speed/zero-servo control.....	216
5.11.3 DC injection brake before start .....	217
5.11.4 Restart mode selection .....	218
5.11.5 Remote setting function selection .....	220
5.11.6 Auto reset function.....	222
5.11.7 Forward and reverse rotation dead time .....	223
5.11.8 Energy-saving function <b>V/F</b> .....	223
5.11.9 Dwell function <b>V/F</b> .....	224
5.11.10 Triangular wave function <b>V/F</b> .....	225
5.11.11 Switch to commercial power supply function .....	226
5.11.12 When input power fail stop function.....	229
5.11.13 VF complete separation.....	231
5.11.14 Regeneration and avoidance function.....	232
5.11.15 Over excitation deceleration function .....	233
5.11.16 Short-circuit brake function at PM motor start.....	233
5.11.17 Built-in PLC.....	234
5.12 Speed and torque control parameter group 11 .....	235
5.12.1 Control parameter.....	237
5.12.2 IM motor estimated speed filtering time .....	238
5.12.3 PM motor setting.....	238
5.12.4 Torque control parameter .....	239
5.12.5 Torque limit.....	241

---

5.12.6	Second motor control parameter	242
5.12.7	Second PM motor setting	243
5.12.8	PM motor speed estimation observer parameters	243
5.12.9	PM Motor current loop controller parameters	244
5.12.10	Velocity loop output low-pass filter time constant	244
5.12.11	PM motor id given low-pass filter time constant	244
5.13	Position control parameter 12	245
5.13.1	Homing mode	247
5.13.2	Position control parameter	250
5.13.3	Zero servo	252
5.13.4	Single point positioning function	252
5.13.5	Position command	253
5.14	Special adjustment parameter group 13	256
5.14.1	Slip compensation <b>V/F</b>	256
5.14.2	Modulation coefficient	256
5.14.3	Vibration inhibition	257
5.14.4	Acceleration torque boost	257
5.15	Tension control parameter group 14	258
5.15.1	Tension control mode selection	260
5.15.2	Tension setting	261
5.15.3	Curling radius calculation	262
5.15.4	Linear speed input	265
5.15.5	Tension compensation	266
5.15.6	Material outage detection	267

5.15.7 Pre-drive control.....	268
5.15.8 Constant linear speed mode .....	270
5.15.9 Tension closed-loop limiter.....	270
5.16 User parameter group 15.....	271
5.16.1 User registered parameter .....	271
6. INSPECTION AND MAINTENANCE.....	273
6.1 Inspection item.....	273
6.1.1 Daily inspection item.....	273
6.1.2 Periodical inspection items .....	273
6.1.3 Diodes and IGBT check.....	274
6.1.4 Cleaning .....	274
6.1.5 Replacement parts.....	275
6.2 Ways to measure voltage, current, power on main circuit.....	276
6.2.1 Measurement instruments choosing .....	276
6.2.2 Measurement of voltages .....	276
6.2.3 Measurement of currents.....	276
6.2.4 Measurement of power .....	277
6.2.5 Measurement of frequency.....	277
6.2.6 Measurement of insulation resistance .....	277
6.2.7 Hi-pot test.....	277
7. APPENDIX .....	278
7.1 Appendix 1 Parameter table.....	278
7.1.1 P parameter mode.....	278
7.1.2 Group mode.....	315

---

7.2 Appendix 2 Alarm code list .....	351
7.3 Appendix 3 Warning Code List .....	357
7.4 Appendix 4 Troubles and solutions .....	358
7.5 Appendix 5 Optional equipment.....	359
7.5.1 Communication card.....	359
7.5.2 I/O card .....	363
7.5.3 PG card .....	365
7.5.4 Keypad.....	368
7.5.5 Data transmission line .....	369
7.5.6 BKU Brake unit.....	370
7.5.7 Expansion card mounting base .....	371
7.6 Appendix 6 European Specification Compatibility Description.....	372
8. REVISION RECORD .....	375

## 1.3 Definitions of terminologies

### ✓ Output frequency, target frequency, steady output frequency

- The actual output current frequency of inverter is called “output frequency.”
- The frequency set by user (via keypad, multi-speed terminals, voltage signal, and current signal or communication settings) is called “target frequency.”
- When motor starts running, inverter output frequency will gradually accelerate to target frequency before it finally runs steadily at the target frequency. This output frequency is called “steady output frequency.”

### ✓ Parameter settings

- Detail explanation on parameter settings are provided in Chapter 5. For users who are not familiar with these settings, arbitrary adjustment of the parameter may result in abnormal operations. All parameters can be reset to their default values by the parameter of 00-02=3(P.998=1). For setting procedures of this parameter, please refer to 00-02=3(P.998=1) in Section 5.1.2.

### ✓ The “operation mode” and “working mode” of the keypad

- Target frequency command source and start signal source depend on inverter operation mode. There are nine operating modes in Shihlin inverter. Please refer to Section 4.3 for details
- The parameter unit is used mainly for monitoring the numeric values, setting parameters and target frequency. There are a total of four working modes on the Shihlin parameter unit. Please refer to Section 4.2 for details.

### ✓ The difference between “terminal name” and “function name”:

- Printed letters can be found near the terminals on control board and main board. They are used to distinguish each terminal and are called “terminal name.”
- For “multi-function control terminal” and “multi-function output terminal,” besides the terminal name, it is also necessary to define the “function name.” The function name indicates the actual functions of the terminal.
- When explaining the function for a terminal, the name used is its “function name”

### ✓ The difference between “on” and “turn on”:

- When explaining the function for the “multi-function digital input terminal”, two words “on” and “turn on” are often used:
- The word “on” is used to indicate that the external switch of the terminal is in close state, and thus it belongs to the description of the state.
- The word “turn on” is used to describe the action that the external switch of the terminal is shut from the open state to the close state, and thus belongs to the description of action. Similarly, the words “off” and “turn off” belong to the above-mentioned states and actions.



## 2. DELIVERY CHECK

Each SE3 inverter has been checked thoroughly before delivery, and is carefully packed to prevent any mechanical damage. Please check for the following when opening the package.

- Check whether the product was damaged during transportation.
- Whether the model of inverter is the same with what is shown on the package.

### 2.1 Nameplate instruction

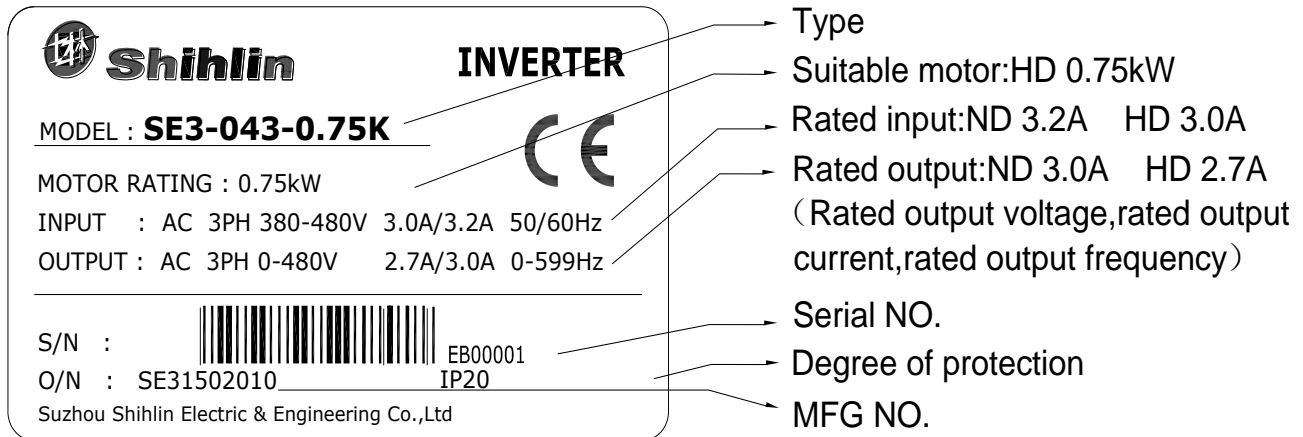

### 2.2 Type instruction

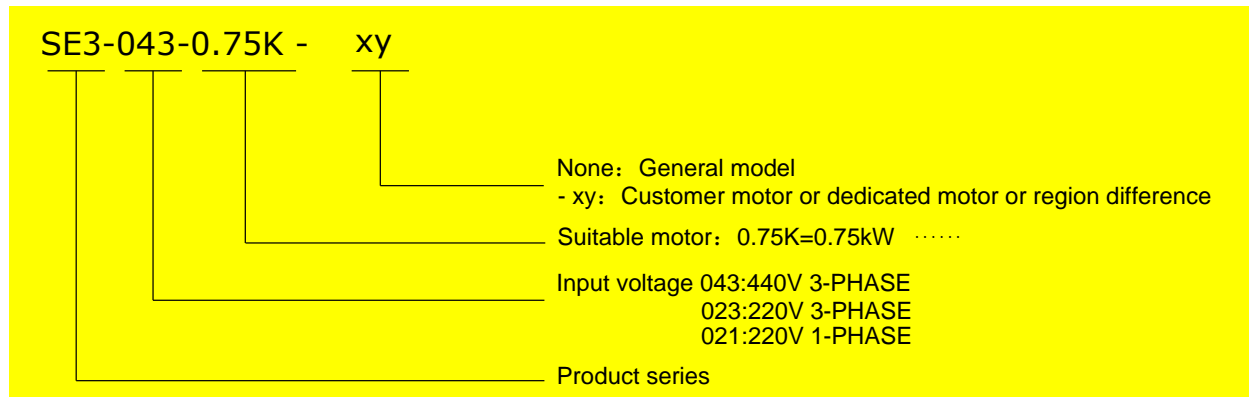

### 2.3 Order code description

Example:

Inverter specification	Specification description	Order code
SE3-043-1.5K	SE3 series 440V 1.5KW inverter	SNKSE30431R5K
SE3-043-7.5K	SE3 series 440V 7.5KW inverter	SNKSE30437R5K
SE3-043-15K	SE3 series 440V 15KW inverter	SNKSE304315K

## 3. INVERTER INTRODUCTION

### 3.1 Electric specification

#### 3.1.1 440V series three-phase

frame		A			B		C			D			
Model SE3-043-【】-xy		0.4K	0.75K	1.5K	2.2K	3.7 K	5.5 K	7.5 K	11 K	15K	18.5K	22K	
Inverter Output	HD	Rated output capacity (kVA)	1	2	3	4.6	6.9	10	14	18	25	29	34
		Rated output current (A)	1.5	2.7	4.2	6	9	12	17	24	32	38	45
		Applicable motor capacity (HP)	0.5	1	2	3	5	7.5	10	15	20	25	30
		Applicable motor capacity (kW)	0.4	0.75	1.5	2.2	3.7	5.5	7.5	11	15	18.5	22
		Overload current rating	150% 60 seconds, 200% 3 seconds (inverse-time characteristics)										
		Carrier frequency (kHz)	1~15KHz										
	ND	Rated output capacity (kVA)	1.4	2.3	3.5	5	8	12	15.6	21.3	27.4	31.6	37.3
		Rated output current (A)	1.8	3	4.6	6.5	10.5	15.7	20.5	28	36	41.5	49
		Applicable motor capacity (HP)	0.5	1	2	3	5	7.5	10	15	20	25	30
		Applicable motor capacity (kW)	0.4	0.75	1.5	2.2	3.7	5.5	7.5	11	15	18.5	22
		Overload current rating	120% 60 seconds (inverse-time characteristics)										
		Carrier frequency (kHz)	1 ~ 15KHz										
	Maximum output voltage		3 phase 380-480V										
	Power Supply	Rated input AC voltage/ frequency		3 phase 380-480V 50Hz / 60Hz									
Permissible AC voltage fluctuation		3 phase 323-528V 50Hz / 60Hz											
Permissible frequency fluctuation		±5%											
Power supply capacity (kVA)		1.5	2.5	4.5	6.9	10.4	11.5	16	20	27	32	41	
Rated input current (A) *Note 1		HD	2.1	3.7	5.8	6.5	9.9	14.3	18.7	27.5	35.2	41.8	48.5
	ND	2.5	4.2	6.4	7.2	11.6	17.3	22.6	30.8	39.6	47.7	53.9	
Cooling method		Self cooling	Fan cooling										
Weight (kg)		1.0	1.0	1.0	1.5	1.5	3.9	4.0	4.0	5.7	5.8	5.8	

Note 1: The value indicates the current at rated output. The rated input current value is not only affected by power transformer, input side reactor, wiring condition, but also fluctuates with the impedance of the power supply side.

Note:

- The value of rated output current is not only affected by the power transformer, input-side reactor, wiring conditions, but also fluctuates with the impedance on the power side.
- The test conditions for rated output current, rated output capacity, inverter power consumption are: carrier frequency (P.72) set default; inverter output voltage 440V; output frequency 60Hz, ambient temperature 40°C.

## 3.1.2 220V series one-phase

Frame		A		B		
Model SE3-021- <b>【】</b> - xy		0.4K	0.75K	1.5K	2.2K	
Inverter Output	HD	Rated output capacity (kVA)	1	1.5	3.2	4.2
		Rated output current (A)	2.7	4.5	8	11
		Applicable motor capacity (HP)	0.5	1	2	3
		Applicable motor capacity (kW)	0.4	0.75	1.5	2.2
		Overload current rating	150% 60 seconds, 200% 3 seconds (inverse-time characteristics)			
		Carrier frequency (kHz)	1~15KHz			
	ND	Rated output capacity (kVA)	1.2	2	3.4	4.8
		Rated output current (A)	3	5	8.5	12.5
		Applicable motor capacity (HP)	0.5	1	2	3
		Applicable motor capacity (kW)	0.4	0.75	1.5	2.2
		Overload current rating	120% 60 seconds (inverse-time characteristics)			
		Carrier frequency (kHz)	1~15KHz			
	Maximum output voltage		3 phase 200-240V			
	Power Supply	Rated input AC voltage/ frequency		Single phase 200-240V 50Hz / 60Hz		
Permissible AC voltage fluctuation		Single phase 170-264V 50Hz / 60Hz				
Permissible frequency fluctuation		±5%				
Power supply capacity (kVA)		1.5	2.5	4.5	6.9	
Rated input current (A) *Note 1		HD	5.9	9.7	14.8	23.1
		ND	6.7	10.5	17.9	26.3
Cooling method		Self cooling	Fan cooling			
Weight (kg)		1.0	1.0	1.5	1.5	

Note 1: The value indicates the current at rated output. The rated input current value is not only affected by power transformer, input side reactor, wiring condition, but also fluctuates with the impedance of the power supply side.

3.1.3 220V series three-phase

Frame		A			B		C		D			
Model SE3-023- <b>[ ]</b> -xy		0.4K	0.75K	1.5K	2.2K	3.7 K	5.5 K	7.5K	11K	15K		
Inverter Output	H	Rated output capacity (kVA)	1.2	2	3.2	4.2	6.7	9.5	12.5	18.3	24.7	
		Rated output current (A)	3	5	8	11	17.5	25	33	49	65	
		Applicable motor capacity (HP)	0.5	1	2	3	5	7.5	10	15	20	
		Applicable motor capacity (kW)	0.4	0.75	1.5	2.2	3.7	5.5	7.5	11	15	
		Overload current rating	150% 60 seconds, 200% 3 seconds (inverse-time characteristics)									
		Carrier frequency (kHz)	1~15kHz									
	N	D	Rated output capacity (kVA)	1.3	2.1	3.4	4.8	7.4	10.3	13.7	19.4	26.3
			Rated output current (A)	3.2	5.5	8.5	12.5	19.5	27	36	51	69
			Applicable motor capacity (HP)	0.5	1	2	3	5	7.5	10	15	20
			Applicable motor capacity (kW)	0.4	0.75	1.5	2.2	3.7	5.5	7.5	11	15
			Overload current rating	120% 60 seconds (inverse-time characteristics)								
			Carrier frequency (kHz)	1~15kHz								
	Maximum output voltage		3 phase 200-240V									
	Power Supply	Rated input AC voltage/ frequency		3 phase 200-240V 50Hz / 60Hz								
Permissible AC voltage fluctuation		3 phase 170-264V 50Hz / 60Hz										
Permissible frequency fluctuation		±5%										
Power supply capacity (kVA)		1.5	2.5	4.5	6.4	10	12	17	20	28		
Rated input current (A) *Note 1		HD	3.5	6.0	9.6	13.2	20.4	30	39.6	58.8	78	
	ND	3.8	6.6	10.2	15	23.4	32.4	43.2	61.2	82.8		
Cooling method		Self cooling	Fan cooling									
Weight (kg)		1.0	1.0	1.0	1.5	1.5	4.0	4.1	5.7	5.8		

Note 1: The value indicates the current at rated output. The rated input current value is not only affected by power transformer, input side reactor, wiring condition, but also fluctuates with the impedance of the power supply side.

Note:

- The value of rated output current is not only affected by the power transformer, input-side reactor, wiring conditions, but also fluctuates with the impedance on the power side.
- The test conditions for rated output current, rated output capacity, inverter power consumption are: carrier frequency (P.72) set default; inverter output voltage 440V; output frequency 60Hz, ambient temperature 40°C.

## 3.2 General specification

Control method		SVPWM control, V/F control, close-loop V/F control (VF+PG), general flux vector control, sensorless vector control (SVC), close-loop vector control (FOC+PG), torque control (TQC+PG).
Output frequency range		0~599Hz (*1)
Frequency setting resolution	Digital setting	The resolution is 0.01Hz.
	Analog setting	0.01Hz/60Hz(terminal 2: -10 ~ +10V / 13bit) 0.15Hz/60Hz(terminal 2: 0 ~ ±10V / 12bit) 0.03Hz/60Hz(terminal 2: 0 ~ 5V / 11bit) 0.06Hz/60Hz(terminal 4: 0~10V, 4-20mA / 12bit) 0.12Hz/60Hz(terminal 4: 0 ~ 5V / 11bit)
Output frequency accuracy	Digital setting	Maximum target frequency±0.01%.
	Analog setting	Maximum target frequency±0.1%.
Speed control range		IM: When SVC, 1:200; when FOC+PG, 1:1000. PM: When SVC, 1:20; when FOC+PG, 1:1000.
Start torque		200% / 0.5 Hz
V/F characteristics		Constant torque curve, variable torque curve, five-point curve, VF separation
Acceleration / deceleration curve characteristics		Linear acceleration /deceleration curve, S shape acceleration /deceleration curve 1 & 2 & 3
Drive motor		Induction motor(IM), permanent magnet motor(SPM, IPM)
Stalling protection		The stalling protection level can be set to 0~250%
Target frequency setting		Keypad setting, DC 0~5V/10V signal, DC -10~+10V signal, DC 4~20 mA signal, multiple speed stage level setting, communication setting, HDI setting.
PID control		Please refer to parameter description
Built-in simple PLC		Supports 21 basic instructions and 12 application instructions, including PC editing software;
Parameter unit	Operation monitoring	Output frequency, output current, output voltage, PN voltage, output torque, electronic thermal accumulation rate, temperature rising accumulation rate, output power, Analog value input signal, digital input and output terminal status...; alarm signal and alarm history 12 groups at most
	LED indicator (7)	Forward rotation indicator, reverse rotation indicator, frequency monitoring indicator, mode switch indicator ,PU control indicator, PLC indicator and run indicator
Communication function		Built-in Shihlin/Modbus communication protocol, can select MODBUS TCP , CANopen、Profibus、DeviceNet、 EtherCAT card
Protection mechanism / alarm function		Output short circuit protection, over-current protection, over-voltage protection, under-voltage protection, motor over-heat protection, IGBT module over-heat protection, communication abnormality protection, PU communication port abnormality protection, memory abnormality protection, PID abnormality protection, CPU abnormality protection, stall prevention protection, short circuit over-current protection, module over-heat protection, over-torque abnormality protection, input power abnormality protection, terminal 4-5 abnormality protection, PG card miscommunication protection, encoder mode abnormality protection, PG card feedback signal abnormality protection, ground current leakage protection, hardware inspection circuit abnormality protection, three-phase current sampling abnormality protection, expansion card abnormality protection

## General specification

Environment	Ambient temperature	Heavy load : -10 ~ +50°C (non-freezing) , Light load : -10 ~ +40°C (non-freezing), please refer to 3.4.2 Class of protection and operation temperature for details.
	Ambient humidity	Below 90%Rh (non-condensing).
	Storage temperature	-20 ~ +65°C.
	Surrounding environment	Indoor, no corrosive gas, no flammable gas, no flammable powder.
	Altitude	Altitude below 2000 meters, when altitude is above 1,000 m, derate the rated current 2% per 100 m
	Vibration	Vibration below 5.9m/s <sup>2</sup> (0.6G).
	Grade of protection	IP20
	The degree of environmental pollution	2
	Class of protection	Class I
International certification	CE	

\*1: Even if the frequency related parameter setting is greater than 599Hz, the actual output frequency upper limit is still 599Hz.

### 3.3 Appearance and dimensions

#### 3.3.1 Frame A

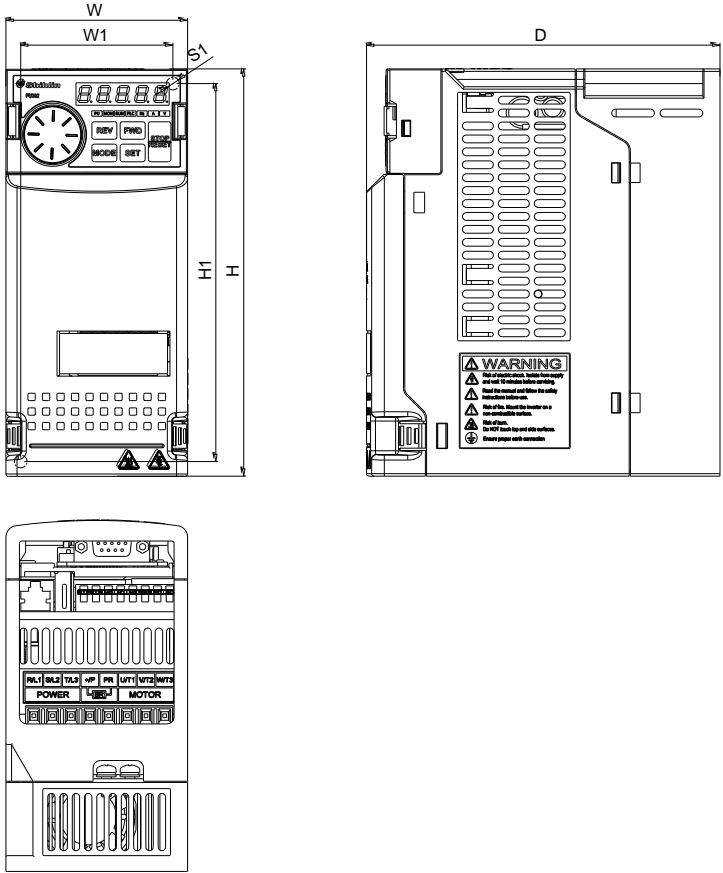

Unit: mm

Model	W	W1	H	H1	D	S1
SE3-043-0.4~1.5K	74.0	62.0	167.0	155.0	144.0	5.2
SE3-023-0.4~1.5K						
SE3-021-0.4~0.75K						

3.3.2 Frame B

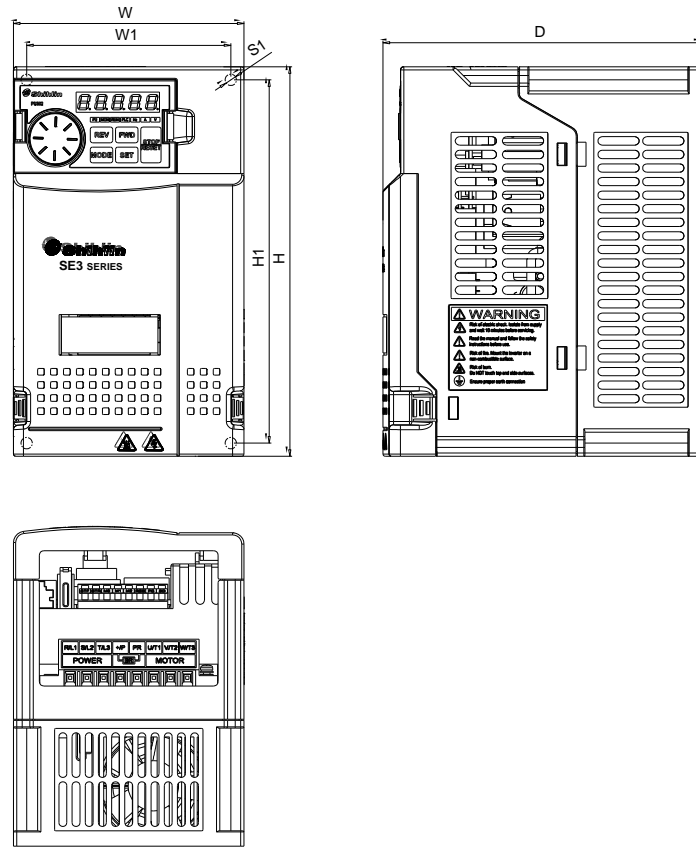

Unit: mm

Model	W	W1	H	H1	D	S1
SE3-043-2.2~3.7K	105.0	93.0	178.0	166.0	146.0	5.2
SE3-023-2.2~3.7K						
SE3-021-1.5~2.2K						



3.3.3 Frame C

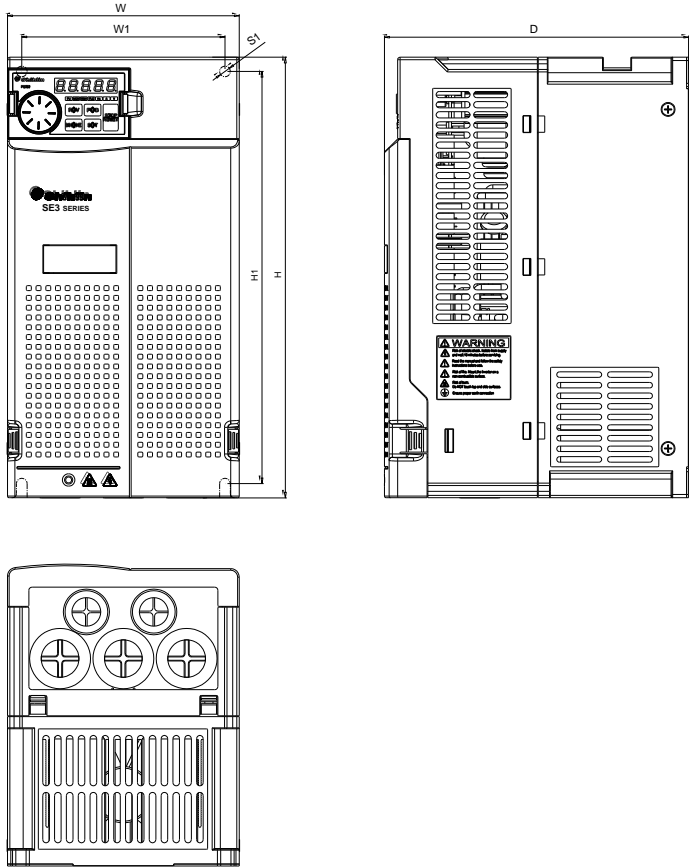

Unit: mm

Model	W	W1	H	H1	D	S1
SE3-043-5.5~11K	141.0	123.6	270.0	252.6	185.0	6.5
SE3-023-5.5~7.5K						

3.3.4 Frame D

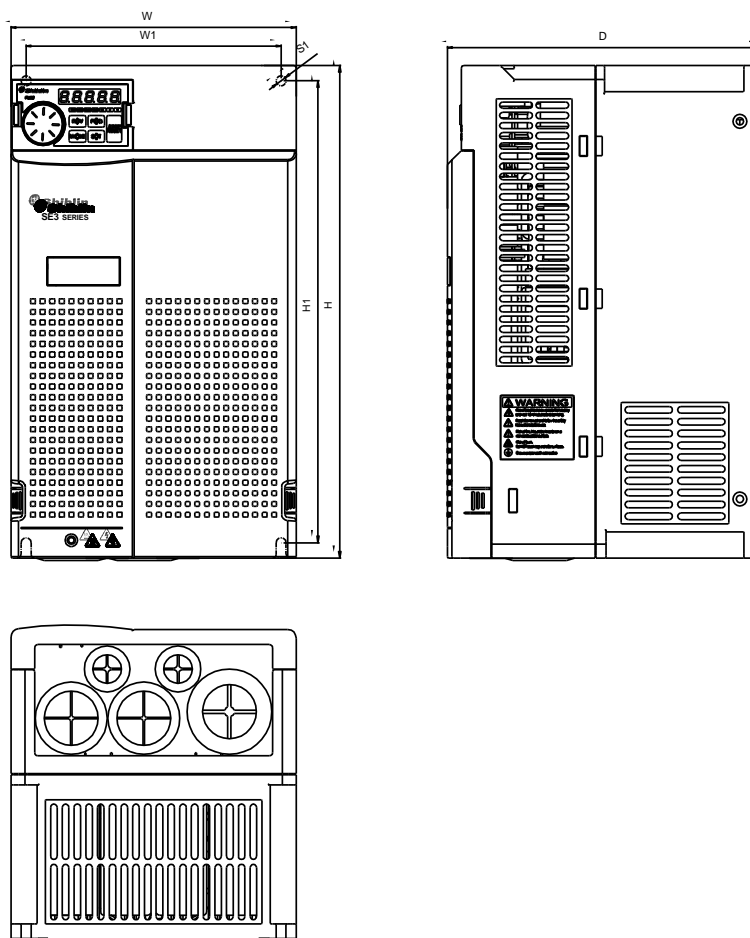

Unit: mm

Model	W	W1	H	H1	D	S1
SE3-043-15~22K	175.0	156.4	300.0	281.4	191.8	6.2
SE3-023-11~15K						

## 3.4 Name of each component

### 3.4.1 Frame A/B/C/D

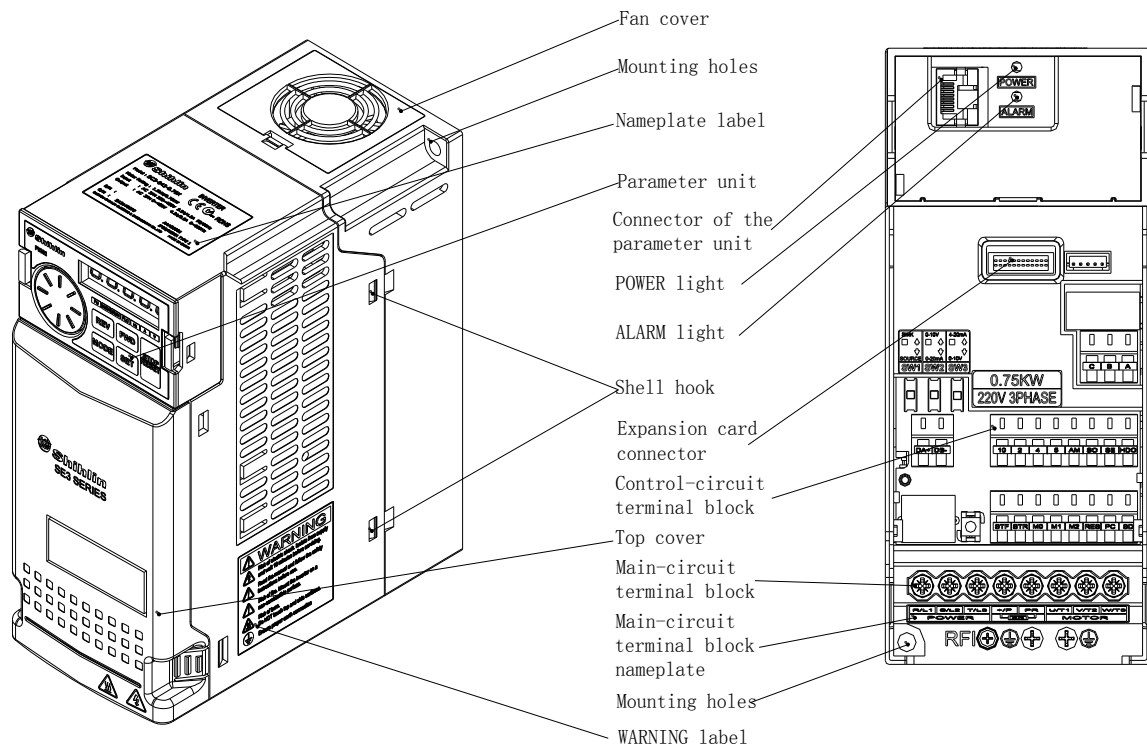

### 3.4.2 Protection level and operation temperature

Frame	NEMA 1 sticker	Conduit box	Protection level	Operation temperature
A/B	--	--	IP20/NEMA TYPE 1	-10 ~ +40°C
C/D	Standard with NEMA 1 sticker	Installation	IP20/NEMA TYPE 1	10 ~ +40°C
	NEMA 1 sticker removed	No installation	IP20/NEMA OPEN TYPE	-10 ~ +50°C

\* 1. Frame A: SE3-043-0.4 ~ 1.5K, SE3-023-0.4 ~ 1.5K, SE3-021-0.4 ~ 0.75K

\* 2. Frame B: SE3-043-2.2 ~ 3.7K, SE3-023-2.2 ~ 3.7K, SE3-021-1.5 ~ 2.2K

\* 3. Frame C: SE3-043-5.5 ~ 11K, SE3-023-5.5 ~ 7.5K

\* 4. Frame D: SE3-043-15 ~ 22K, SE3-023-11 ~ 15K

## 3.5 Installation and wiring

### 3.5.1 Transportation

Hold the body when carrying and don't only hold the cover or any part of the inverter, otherwise it may drop down.

### 3.5.2 Stockpile

The product must be placed in the packaging box before installation. In order to make the product conform to the scope of warranty of the company and facilitate maintenance in the future, please pay attention to the following matters when storing if the inverter will not be used temporarily:

1. Must be placed in dry places without dirt and dust.
2. The environment temperature for storage place must range from -20°C to +65°C.
3. The relative humidity for storage place must range from 0% to 90%, and no condensation.
4. Avoid storing in the environment containing corrosive gas or liquid.
5. It's better to be packed properly and kept on shelf or table.

Note: 1. Even if the storing place humidity meets the standard requirements, icing and condensation can also occur if the temperature changes rapidly, thus should be avoided.

2. Don't place it on the ground, it should be placed on a shelf. If the environment is bad, put desiccant in the packaging bag.

3. If the storage period is more than 3 months, the storing temperature should not be higher than 30°C. Considering that capacitors will easily degrade in high temperature without being powered on.

4. If the inverter is installed in a machine or control panel when not in use (especially in construction site or humid and dusty places), the inverter should be removed and put in suitable environment according to the above storage conditions.

5. If the inverter isn't power on for a long time, the capacitors will degrade. Do not place it for more than one year without being powered on.

### 3.5.3 Installation notice

**When installing, it is recommended to place the inverter away from heat sources, radiation sources and other equipment that can damage the inverter.**

✓ Before installing, please confirm whether meet the conditions listed in the table below:

Ambient temperature	Heavy load : -10 ~ +50°C (non-freezing) , Light load : -10 ~ +40°C (non-freezing), please refer to 3.4.2 Class of protection and operation temperature for details.
Ambient humidity	Below 90%Rh (non-condensing).
Storage temperature	-20 ~ +65°C.
Surrounding environment	Indoor, no corrosive gas, no flammable gas, no flammable powder.
Altitude	Altitude below 2000 meters, when altitude is above 1,000 m, derate the rated current 2% per 100 m
Vibration	Vibration below 5.9m/s <sup>2</sup> (0.6G).
Grade of protection	IP20 / NEMA TYPE 1
The degree of environmental pollution	2
Class of protection	Class I

✓ Please install the inverter vertically in order not to reduce the heat dissipation effect:

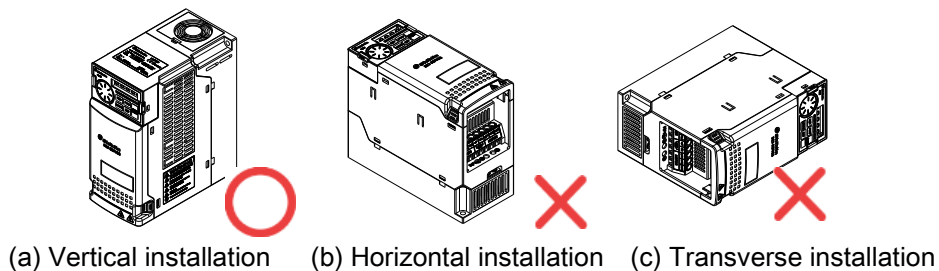

✓ Please follow the installation restrictions shown below to ensure enough ventilation space for inverter cooling and wiring space:

• Arrangement of single or paralleling inverter:

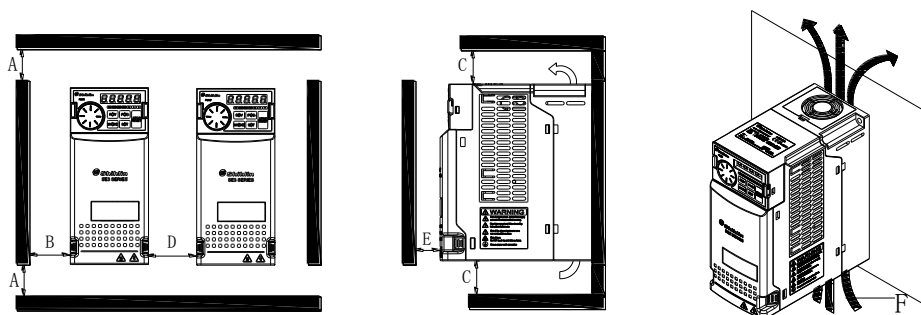

Unit: mm

Size	Frame A~B	Frame C~D
A	50	50
B	10	50
C	100	100
D	10	50
E	10	50
F	Ventilation direction	

• Arrangement of multiple inverters:

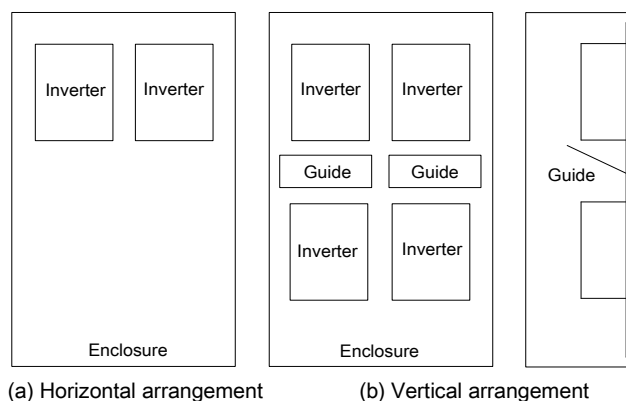

Note: 1. When installing the inverters of different sizes in parallel, please align the top of all inverters before installation, for easier fan replacement.  
 2. When it is inevitable to arrange inverters vertically to minimize space, install guides since heat from the bottom inverters can increase the temperature on the top inverters, causing inverter failures.

### 3.5.4 EMC installation instructions

Just as other electrical and electronic equipments, an inverter is the source of electromagnetic interference and an electromagnetic receiver when working with a power system. The amount of electromagnetic interference and noise is determined by the working principles of an inverter. In order to guarantee the inverter working reliably in the electromagnetic environment, it must have a certain ability of anti-electromagnetic interference in design. In order to make the drive system work normally, please meet the following several aspects requirements in installation:

✓ **Field wiring**

Power line supply electric independently from power transformer, five or four core line are generally used, null line and ground sharing a single line is forbidden.

Commonly signal wire (weak) and power wire (heavy) are in control cabinet, for the inverter, power wire is divided into input line and output line. Signal wire is easily interfered by power wire, so that causing the misoperation of the device. When wiring, signal wire and power wire should be distributed in different areas, parallel lines and interlaced lines are forbidden at close range(within 20cm), and especially don't bundle up the two lines. If the signal cables must pass via the power lines, the two should keep 90 degree Angle. Interlace lines and banding together is also forbidden for the input and output line of power wire, especially on the occasions which noise filter is installed. It will cause the coupling of electromagnetic noise via the distributed capacitance of the input and output lines, thus the noise filter will out of action.

Generally a control cabinet has different electric equipments such as inverter, filter, PLC, measurement instrument, their ability of emitting and bearing electromagnetic noise are diverse from each other, and this requires classifying these equipments. The classification can be divided into strong noise equipment and noise sensitive equipment, Install the similar equipments in the same area and, and keep a distance more than 20cm among inhomogeneous equipments.

✓ **Input noise filter, input and output magnet ring (Zero phase reactor)**

Adding noise filter to the input terminal, the inverter will be isolated from the other equipments, and its ability of conduction and radiation will be reduced effectively. The better EMI suppression effect will be obtained by installing the input reactor recommended by this manual. By adding winding ferrite bead to the input and output terminal and coordinating with internal filter, the inverters will have a better effect.

✓ **Shielding**

Good shielding and grounding can greatly reduce the interference of inverter, and can improve the anti-interference ability of the inverter. Sealing off the inverter with the good conductive sheet metal and connecting the sheet metal to ground, the radiation interference will be reduced effectively. To reduce the interference of inverter and improve the anti-interference ability, cable with shielding layer should be used in input and output and the both ends of it should be connected to ground. Shielding cable is suggested to be used in control connecting and communication connecting of the inverter external terminals under bad electromagnetic environment. Generally, the both ends of shielding layer should be connected to the control /communication ground, and they can also be connected to ground.

✓ **Grounding**

The inverter must be connected to the ground safely and reliably. Grounding is not only for equipment and personal safety, but also the simplest, the most efficient and the lowest cost method to solving the EMC problem, so it should be prioritized. Please refer to the section of "3.7 Terminal wire arrangement".

✓ **Carrier wave**

The leakage current contains the leakage current from line to line or over the ground. It depends on the size of the distributed capacitance when wiring and the carrier frequency of the frequency. The higher the carrier frequency, the longer the motor cable, and the larger the cable cross-sectional area is, the larger the leakage current is. Reducing the carrier frequency can effectively reduce the leakage current. When the motor line is long (50m above), the output side should be installed with ac reactor or sine wave filter, when the motor line is longer, a reactor should be installed every other distance. At the same time, reducing carrier frequency can effectively reduce the conduction and radiation interference.

### 3.5.5 Removing front cover

#### ✓ Frame A/B

\* 1. Frame A: SE3-043-0.4 ~ 1.5K, SE3-023-0.4 ~ 1.5K, SE3-021-0.4 ~ 0.75K

\* 2. Frame B: SE3-043-2.2 ~ 3.7K, SE3-023-2.2 ~ 3.7K, SE3-021-1.5 ~ 2.2K

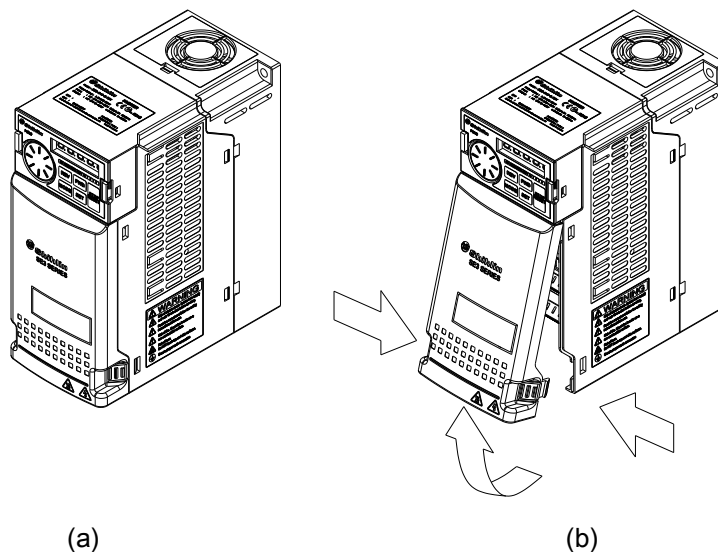

(a) Loosen the screws on the wiring front cover.

(b) While holding the areas around the installation hooks on the sides of the wiring front cover, pull out the wiring front cover using its upper side as a support.

#### ✓ Frame C/D

\* 1. Frame C: SE3-043-5.5 ~ 11K, SE3-023-5.5 ~ 7.5K

\* 2. Frame D: SE3-043-15 ~ 22K, SE3-023-11 ~ 15K

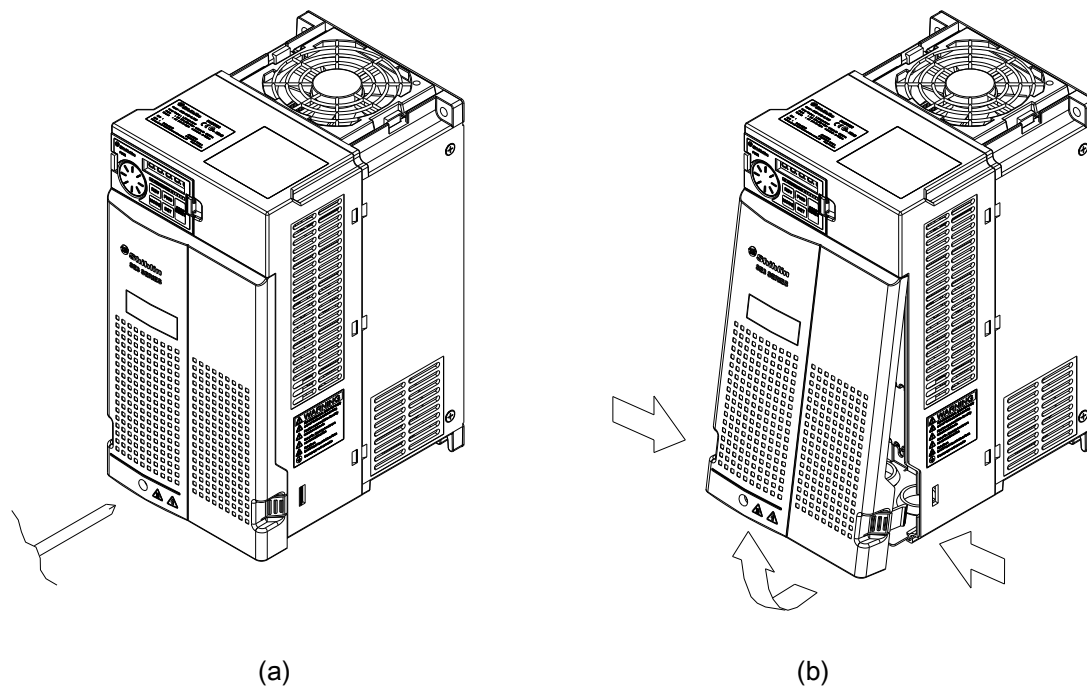

(a) Loosen the screws on the wiring front cover.

(b) While holding the areas around the installation hooks on the sides of the wiring front cover, pull out the wiring front cover using its upper side as a support.

### 3.6 Peripheral devices

#### 3.6.1 System Wire Arrangement

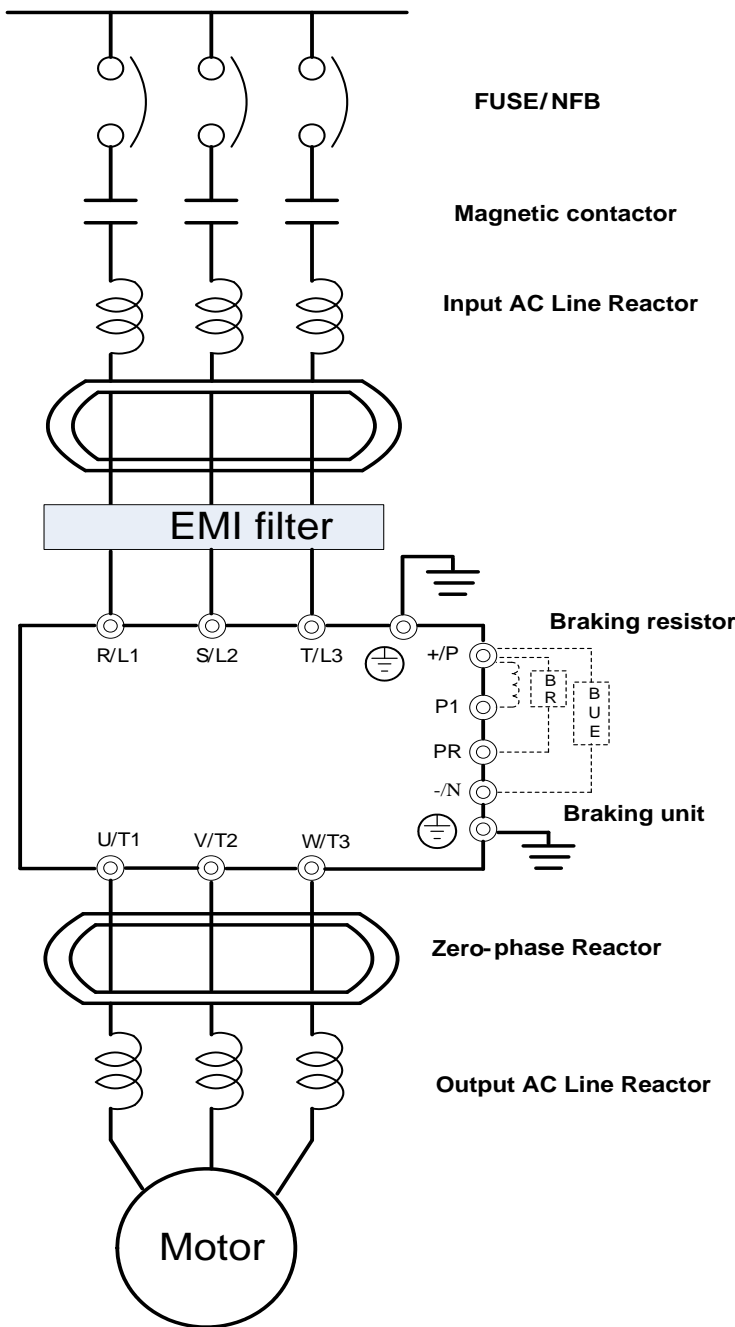

Power supply	Please follow the specific power supply requirement shown in this manual.
Fuse/NFB	There may be an inrush current during power up. Please refer to 3.7.1 and select the correct fuse /NFB.
Magnetic contactor	Please do not use a Magnetic contactor as the I/O switch of the inverter, as it will reduce the operating life cycle of the inverter.
Input AC Line Reactor	AC line reactor should be installed to improve the input power factor. The wiring distance should be less than 10m. Please refer to 3.7.6.
Zero-phase Reactor	Zero-phase reactors are used to reduce radio noise especially when audio equipment installed near the inverter. Effective for noise reduction on both the input and output sides. The frequency band effective range is from 1MHz to 10 MHz. Please refer to 3.7.5.
EMI filter	Used to reduce electromagnetic interference.
Braking unit	Used to reduce stopping time of the motor.
Output AC Line Reactor	Motor surge voltage amplitudes depending on motor cable length. The output AC line reactor is necessary to install on the inverter output side. Please refer to 3.7.6.



## 3.6.2 No-fuse breaker and magnetic contactor

Inverter model	Motor capacity	Power source capacity	Applicable no-fuse switch (NFB/MCCB) type (Shihlin Electric)	Applicable electromagnetic contactor (MC) type (Shihlin Electric)
SE3-043-0.4K	440V 0.5HP	1 kVA	BM30SN3P3A	S-P11
SE3-043-0.75K	440V 1HP	2.5 kVA	BM30SN3P5A	S-P11
SE3-043-1.5K	440V 2HP	4.8kVA	BM30SN3P10A	S-P11
SE3-043-2.2K	440V 3HP	6.9kVA	BM30SN3P15A	S-P21
SE3-043-3.7K	440V 5HP	10.4kVA	BM30SN3P20A	S-P21
SE3-043-5.5K	440V 7.5HP	11.5 kVA	BM30SN3P30A	S-P21
SE3-043-7.5K	440V 10HP	16 kVA	BM30SN3P30A	S-P21
SE3-043-11K	440V 15HP	20 kVA	BM60SN3P50A	S-P30T
SE3-043-15K	440V 20HP	27 kVA	BM60SN3P60A	S-P40T
SE3-043-18.5KF	440V 25HP	32 kVA	BM100SN3P75A	S-P40T
SE3-043-22K	440V 30HP	41 kVA	BM100SN3P100A	S-P50T
SE3-023-0.4K	220V 0.5HP	0.5kVA	BM30SN3P5A	S-P11
SE3-023-0.75K	220V 1HP	2.5kVA	BM30SN3P10A	S-P11
SE3-023-1.5K	220V 2HP	4.5kVA	BM30SN3P15A	S-P11
SE3-023-2.2K	220V 3HP	6.4kVA	BM30SN3P20A	S-P11/S-P12
SE3-023-3.7K	220V 5HP	10kVA	BM30SN3P30A	S-P21
SE3-023-5.5K	220V 7.5HP	12kVA	BM60SN3P50A	S-P25
SE3-023-7.5K	220V 15HP	20 kVA	BM100SN3P100A	S-P35T
SE3-023-11K	220V 20HP	28 kVA	BM160SN3P125A	S-P50T
SE3-023-15K	220V 25HP	34 kVA	BM160SN3P160A	S-P60T
SE3-021-0.4K	220V 0.5HP	1 kVA	BM30SN3P3A	S-P11
SE3-021-0.75K	220V 1HP	2.5kVA	BM30SN3P10A	S-P11
SE3-021-1.5K	220V 2HP	4.5kVA	BM30SN3P15A	S-P11
SE3-021-2.2K	220V 3HP	6.9kVA	BM30SN3P15A	S-P11/S-P12

## 3.6.3 Regenerative Brake Resistor

Voltage	Motor (kW)	Braking Resistor (10%ED , Braking Torque 125%)	Maximum braking torque limit		
		Resistor specifications	Minimum resistance value( $\Omega$ )	Highest total braking current(A)	Maximum peak power(kW)
021	0.4	40W 375 $\Omega$	220	2	0.6
	0.75	75W 200 $\Omega$	120	3	1.1
	1.5	150W 100 $\Omega$	60	6	2.2
	2.2	220W 68.2 $\Omega$	60	6	2.2
023	0.4	40W 375 $\Omega$	220	2	0.6
	0.75	75W 200 $\Omega$	120	3	1.1
	1.5	150W 100 $\Omega$	60	6	2.2
	2.2	220W 68.2 $\Omega$	60	6	2.2
	3.7	370W 40.5 $\Omega$	40	9	3.2
	5.5	550W 27.3 $\Omega$	30	12	4.3
	7.5	750W 20 $\Omega$	20	18	6.5
	11	1100W 13.6 $\Omega$	13.6	26	9.5
043	0.4	40W 1500 $\Omega$	1000	1	0.5
	0.75	75W 800 $\Omega$	800	1	0.7
	1.5	150W 400 $\Omega$	320	2	1.6
	2.2	220W 272.8 $\Omega$	160	5	3.2
043	3.7	370W 162.2 $\Omega$	120	6	4.3
	5.5	550W 109.1 $\Omega$	75	10	6.9
	7.5	750W 80 $\Omega$	75	10	6.9
	11	1100W 54.6 $\Omega$	50	14	10.4
	15	1500W 40 $\Omega$	40	18	13.0
	18.5	1850W 32.4 $\Omega$	32	23	16.2
	22	2200W 27.3 $\Omega$	27.2	26	19.1

Note: 1.The resistance of brake resistors for built in braking unit is based on 10% regenerative brake duty (when used for 5 seconds, the machine has to be stopped for another 45 seconds for heat dissipation). For models without a built-in brake unit, the resistance of brake resistors is based on the brake duty of the selected brake unit. The regenerative brake resistor wattage can be reduced according to the user's application (quantity of heat) and the regenerative brake duty. But the resistance must be larger than the value (ohms) listed in the above table (otherwise the inverter will be damaged).

2. In case frequent start and stop operations are required, a larger regenerative brake duty should be set. Meanwhile, a large brake resistor should be used correspondingly. Please feel free to contact us if there is any problem regarding the selection of brake resistors.

In order to prevent the braking resistor from overheating or burning out when the regenerative braking transistor is damaged, it is recommended to use the sequential control program shown in the figure below.

Example 1 :

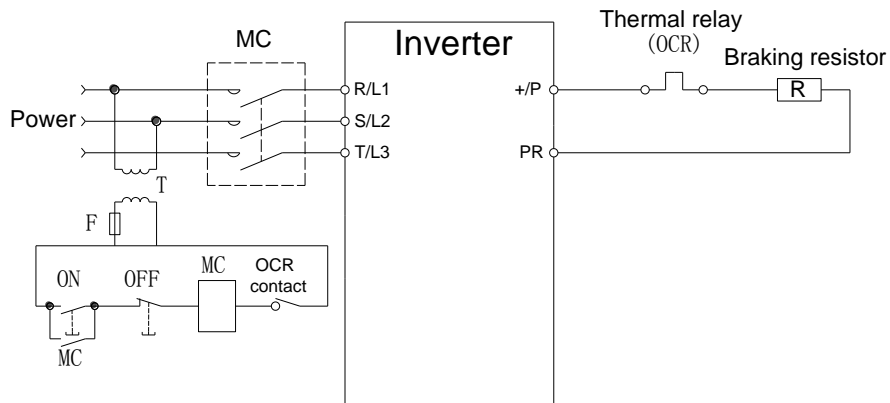

Example 2 :

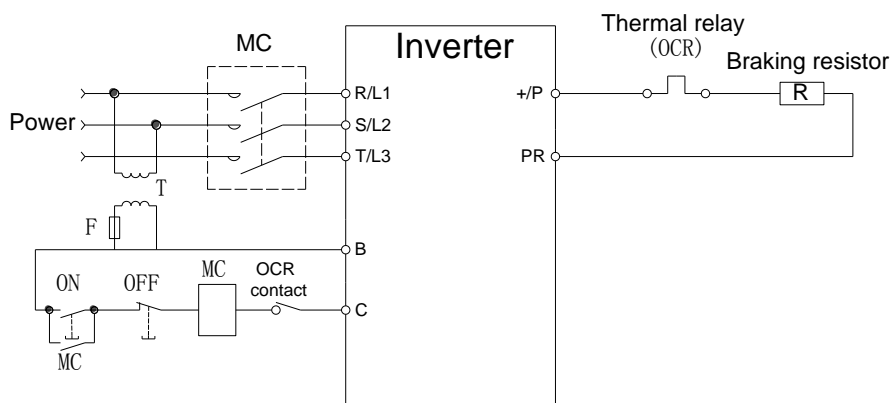

## 3.6.4 Reactor

## ✓ AC input reactor

Inverter model	Recommended Reactor		
	Shihlin type	Rated current (A)	Inductance (mH)
SE3-043-0.4K	SH-ACL-0004-05350	4	5.35
SE3-043-0.75K	SH-ACL-0004-05350	4	5.35
SE3-043-1.5K	SH-ACL-0004-05350	4	5.35
SE3-043-2.2K	SH-ACL-0006-03710	6	3.71
SE3-043-3.7K	SH-ACL-0010-02260	10	2.26
SE3-043-5.5K	SH-ACL-0013-01540	13	1.54
SE3-043-7.5K	SH-ACL-0019-01150	19	1.15
SE3-043-11K	SH-ACL-0026-00790	26	0.79
SE3-043-15K	SH-ACL-0034-00590	34	0.59
SE3-043-18.5K	SH-ACL-0043-00480	43	0.48
SE3-043-22K	SH-ACL-0048-00400	48	0.4
SE3-023-0.4K	SH-ACL-0004-05350	4	5.35
SE3-023-0.75K	SH-ACL-0004-05350	4	5.35
SE3-023-1.5K	SH-ACL-0007-01340	7	1.340
SE3-023-2.2K	SH-ACL-0009-00930	9	0.930
SE3-023-3.7K	SH-ACL-0016-00570	16	0.570
SE3-023-5.5K	SH-ACL-0022-00380	22	0.380
SE3-023-7.5K	SH-ACL-0030-00290	30	0.290
SE3-023-11K	SH-ACL-0043-00200	43	0.200
SE3-023-15K	SH-ACL-0059-00150	59	0.150
SE3-021-0.4K	SH-ACL-0004-05350	4	5.35
SE3-021-0.75K	SH-ACL-0004-05350	4	5.35
SE3-021-1.5K	SH-ACL-0007-01340	7	1.340
SE3-021-2.2K	SH-ACL-0009-00930	9	0.930

## AC output reactor

Inverter model	Recommended reactor		
	Shihlin Type	Rated current (A)	Inductance(mH)
SE3-043-0.4K	SH-OCL-0005-01394	5	1.394
SE3-043-0.75K	SH-OCL-0005-01394	5	1.394
SE3-043-1.5K	SH-OCL-0005-01394	5	1.394
SE3-043-2.2K	SH-OCL-0007-01000	7	1.000
SE3-043-3.7K	SH-OCL-0010-00700	10	0.700
SE3-043-5.5K	SH-OCL-0015-00470	15	0.465
SE3-043-7.5K	SH-OCL-0020-00350	20	0.350
SE3-043-11K	SH-OCL-0030-00230	30	0.230
SE3-043-15K	SH-OCL-0040-00180	40	0.180
SE3-043-18.5K	SH-OCL-0050-00140	50	0.140
SE3-043-22K	SH-OCL-0060-00120	60	0.120
SE3-023-0.4K	SH-OCL-0005-01394	5	1.394
SE3-023-0.75K	SH-OCL-0005-01394	5	1.394
SE3-023-1.5K	SH-OCL-0007-01000	7	1.000
SE3-023-2.2K	SH-OCL-0015-00470	15	0.465
SE3-023-3.7K	SH-OCL-0020-00350	20	0.35
SE3-023-5.5K	SH-OCL-0030-00230	30	0.23
SE3-023-7.5K	SH-OCL-0040-00180	40	0.18
SE3-023-11K	SH-OCL-0060-00120	60	0.12
SE3-023-15K	SH-OCL-0080-00087	80	0.087
SE3-021-0.4K	SH-OCL-0005-01394	5	1.394
SE3-021-0.75K	SH-OCL-0005-01394	5	1.394
SE3-021-1.5K	SH-OCL-0007-01000	7	1.000
SE3-021-2.2K	SH-OCL-0015-00470	15	0.465

## ✓ DC reactor

Inverter model	Recommended reactor		
	Shihlin Type	Rated current (A)	Inductance(mH)
SE3-043-5.5K	SH-DCL-0014-03450	14.0	3.45
SE3-043-7.5K	SH-DCL-0020-02380	20.4	2.38
SE3-043-11K	SH-DCL-0027-01770	27.5	1.77
SE3-043-15K	SH-DCL-0034-01440	33.9	1.44
SE3-043-18.5K	SH-DCL-0040-01210	40.3	1.21
SE3-043-22K	SH-DCL-0055-00900	55.0	0.90
SE3-023-5.5K	SH-DCL-0033-00860	33.4	0.86
SE3-023-7.5K	SH-DCL-0048-00600	48.1	0.60
SE3-023-11K	SH-DCL-0065-00450	64.7	0.45
SE3-023-15K	SH-DCL-0080-00360	79.9	0.36

## 3.6.5 Filter

Inverter model	kW	HP	Rated Amps of reactor	Types of filter
SE3-043-0.4K	0.4	0.5	1.8	NF311A5/01
SE3-043-0.75K	0.75	1	3.0	NF311A5/01
SE3-043-1.5K	1.5	2	4.2	NF311A10/01
SE3-043-2.2K	2.2	3	6	NF311A10/01
SE3-043-3.7K	3.7	5	9	NF311A20/05
SE3-043-5.5K	5.5	7.5	12	NF311A20/05
SE3-043-7.5K	7.5	10	17	NF311A30/05
SE3-043-11K	11	15	24	NF311A50/05
SE3-043-15K	15	20	32	NF311A50/05
SE3-043-18.5K	18.5	25	38	NF311A50/05
SE3-043-22K	22	30	45	NF311A80/05
SE3-023-0.4K	0.4	0.5	3	NF311A10/01
SE3-023-0.75K	0.75	1	5	NF311A10/01
SE3-023-1.5K	1.5	2	8	NF311A20/05
SE3-023-2.2K	2.2	3	11	NF311A20/05
SE3-023-3.7K	3.7	5	17.5	NF311A30/05
SE3-023-5.5K	5.5	7.5	25	NF311A50/05
SE3-023-7.5K	7.5	10	33	NF311A50/05
SE3-023-11K	11	15	49	NF311A80/05
SE3-021-0.4K	0.4	0.5	3	NF311A10/01
SE3-021-0.75K	0.75	1	5	NF311A10/01
SE3-021-1.5K	1.5	2	8	NF311A20/05
SE3-021-2.2K	2.2	3	11	NF311A20/05

Note: Products of CHANGZHOU DUOJI EME TECHNICAL CO., LTD are recommended for the filter used here.

### 3.7 Terminal wire arrangement

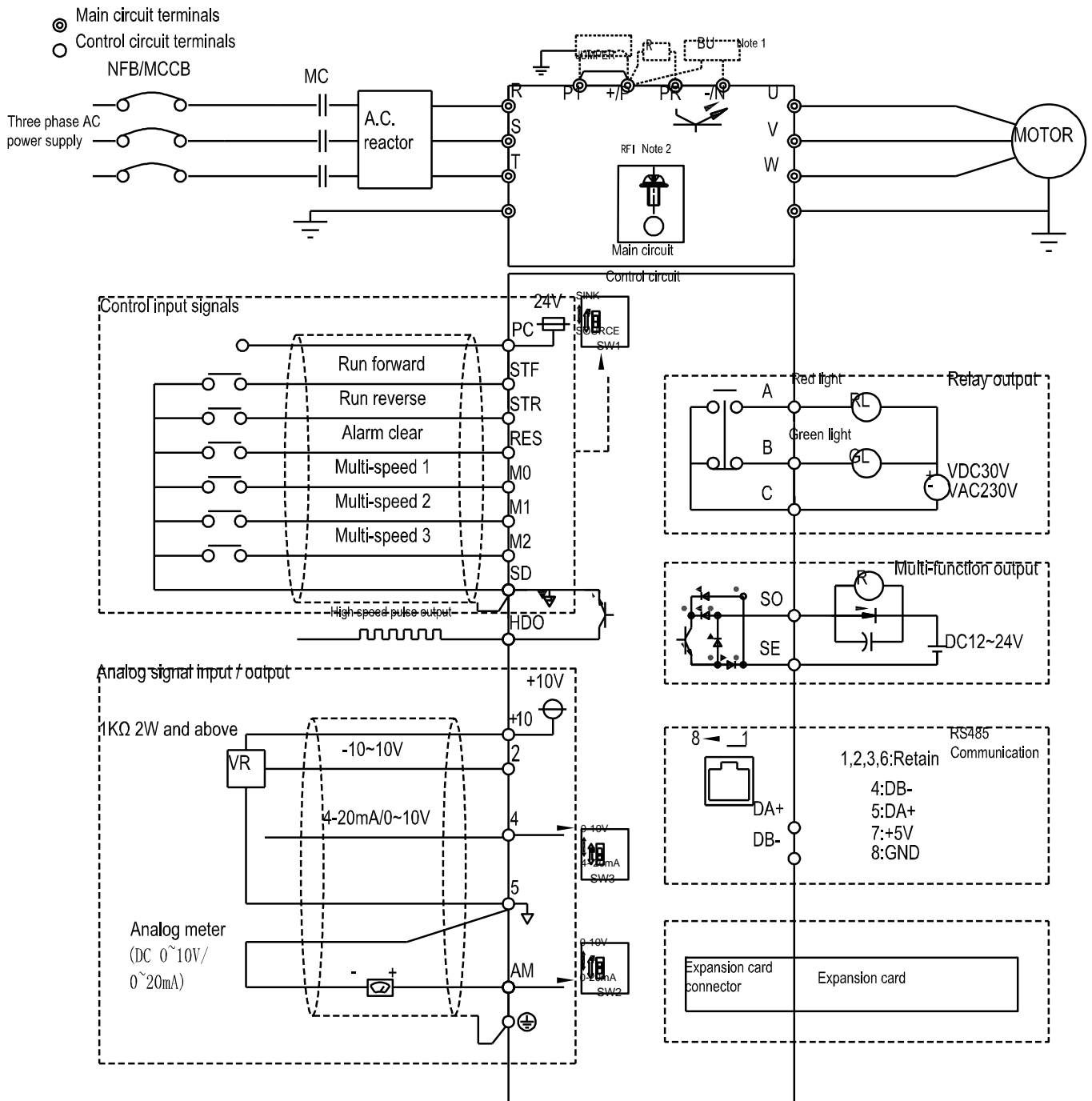

- Note: 1: All series includes built-in braking units, please connect braking resistor between + / P, PR.
- 2: All series includes built-in RFI filters to suppress electromagnetic interference, but if you need to comply with CE regulations, please refer to the relevant instructions in the manual for installation.
- 3: In order to improve the braking ability during deceleration, the frame C / D external braking unit can be connected between (+ / P)-(-N). For details, please refer to Section 3.7.1.
- 4: When adding a DC reactor on C / D frame inverter, jumper between + / P and P1 must be removed. For the selection of reactor, refer to section 3.6.4.
- 5: Do not short the 10, SD, SE, 5, and PC terminals to each other.
- 6: Please refer to section 5.3.9 for HDO wiring.

### 3.7.1 Main circuit Terminals

#### ✓ Description

Terminal symbol	Description
R/L1-S/L2-T/L3	Connect to commercial power supply
U/T1-V/T2-W/T3	Connect to three-phase induction motor.
P1-(+/P)	Connect to DC reactor. (AB frame without P1 terminal)
(+/P)-PR	Connect to brake resistor
(+/P)-(-/N)	Connect to brake unit or input DC voltage(AB frame without -/N terminal)

Note: 1. For SE3 series inverters, brake resistor is not included. For information related to braking resistor, please refer to Section 3.6.3 and 3.7.1.

2. For information related to regenerative voltage, please refer to 06-05 (P.30) and 06-06 (P.70) in Section 5.7.3.

3. +/P and -/N are the positive and negative terminals of the internal DC voltage of the inverter. In order to strengthen the braking capacity during deceleration, it is suggested to purchase the optional "brake unit" which is mounted between the terminals +/P and -/N. The "brake unit" can effectively dissipate the feedback energy from the motor to the inverter when decelerating.

4. In case there is any problem on purchasing "brake unit," please feel free to contact us.

#### ✓ Terminal layout of the main circuit terminals

##### • Frame A

SE3-043-0.4~1.5K, SE3-023-0.4~1.5K, SE3-021-0.4~0.75K

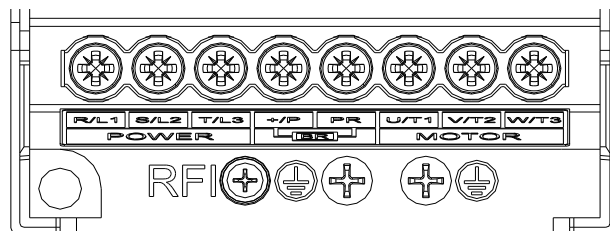

##### • Frame B

SE3-043-2.2~3.7K, SE3-023-2.2~3.7K, SE3-021-1.5~2.2K

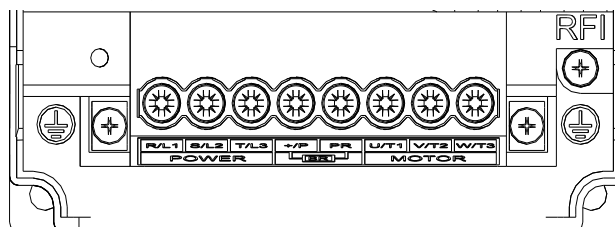

##### • Frame C

SE3-043-5.5~11K, SE3-023-5.5~7.5K

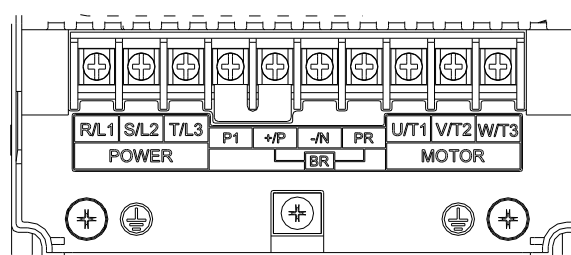

## Terminal wire arrangement

- Frame D

SE3-043-15~22K, SE3-023-11~15K

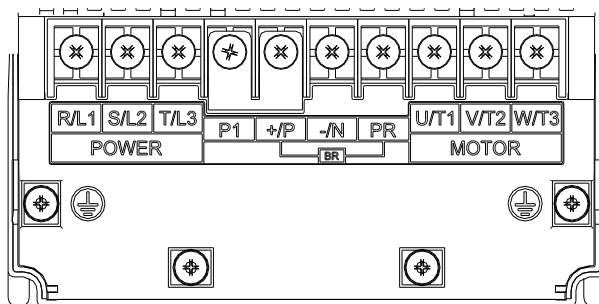

- ✓ DC reactor connection

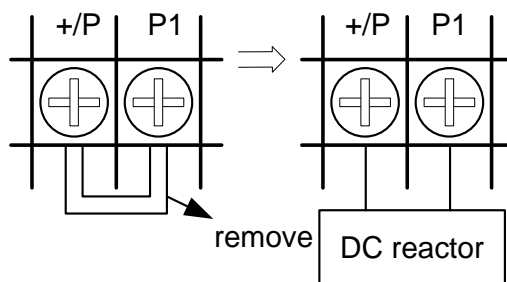

- ✓ Brake unit connection

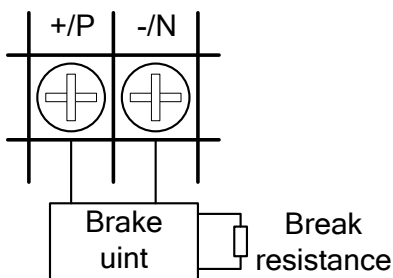

Note: BKU brake unit and brake resistance are optional for frame C and D. See details in 7.5.6. Refer to section 3.3 for a description of the framework.

\* 1. Frame C: SE3-043-5.5 ~ 11K, SE3-023-5.5 ~ 7.5K

\* 2. Frame D: SE3-043-15 ~ 22K, SE3-023-11 ~ 15K

- ✓ Brake resistor connection

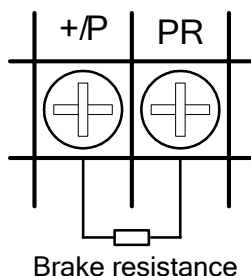

Note: For frame A, B, C and D inverters. Please refer to Section 3.3 for instruction on the frames.



## 3.7.2 Main circuit wiring and terminal specification

Inverter model	Terminal screw specifications	Tightening torque (Kgf.cm)	Recommended wiring specification (mm <sup>2</sup> )				Recommended wiring specification (AWG)			
			R,S,T	U,V,W	+/P,P1	Grounding Cable	R,S,T	U,V,W	+/P,P1	Grounding Cable
SE3-021-0.4k	M3	6~8	2.5	2.5	2.5	2.5	14	14	14	14
SE3-021-0.75k			2.5	2.5	2.5	2.5	14	14	14	14
SE3-023-0.4k			2.5	2.5	2.5	2.5	14	14	14	14
SE3-023-0.75k			2.5	2.5	2.5	2.5	14	14	14	14
SE3-023-1.5k			2.5	2.5	2.5	2.5	14	14	14	14
SE3-043-0.4K			2.5	2.5	2.5	2.5	14	14	14	14
SE3-043-0.75K			2.5	2.5	2.5	2.5	14	14	14	14
SE3-043-1.5K			2.5	2.5	2.5	2.5	14	14	14	14
SE3-021-1.5k			6	6	6	6	10	10	10	10
SE3-021-2.2k			6	6	6	6	10	10	10	10
SE3-023-2.2k			4	4	4	4	12	12	12	12
SE3-023-3.7K			6	6	6	6	10	10	10	10
SE3-043-2.2K			2.5	2.5	2.5	2.5	14	14	14	14
SE3-043-3.7K			2.5	2.5	2.5	2.5	14	14	14	14
SE3-023-5.5k			M4	15~18	10	10	10	10	8	8
SE3-023-7.5k	10	10			10	10	8	8	8	8
SE3-043-5.5K	6	6			6	6	10	10	10	10
SE3-043-7.5K	6	6			6	6	10	10	10	10
SE3-043-11K	10	10			10	10	8	8	8	8
SE3-023-11k	M5	18~20	25	25	25	25	4	4	4	4
SE3-023-15k			25	25	25	25	4	4	4	4
SE3-043-15K			10	10	10	10	8	8	8	8
SE3-043-18.5K			16	16	16	16	6	6	6	6
SE3-043-22K			25	25	25	25	4	4	4	4

Note: 1. Do not connect power wire to motor terminals (U/T1) - (V/T2) - (W/T3) on inverter, otherwise it will cause damage.

2. Do not add phase capacitor, surge absorber or magnetic contactor on the output of the inverter.

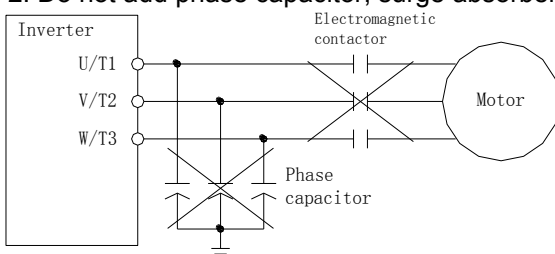

3. Do not use the "magnetic contactor" or "no fuse switch" to start and stop the motor.

4. Please do grounding for the inverter and motor to avoid electric shock.

5. For specifications of no-fuse breaker and magnetic contactor, please refer to section 3.6.2.

6. If the distance between the inverter and motor is long, please use thick wires, make sure wire voltage drop is under 2V (wire length below 500 meters).

7. Use "insulation crimp sleeve" for power supply side and load side connection.

8. After cutting off terminal power, high voltage still exist between (+/P) and (-/N) in short period of time. Within 10 minutes, do not touch terminals to avoid electric shock.

### 3.7.3 Ground

For safety and to reduce noise, the grounding  $\oplus$  of the inverter must be well grounded. To avoid electric shocks and fire accident, the external metal ground wire of the equipment should be short and thick, and should be connected to specific grounding terminals on the inverter. If several inverters are placed together, all inverters must be connected to the common ground. Please refer to the following diagrams and ensure that no loop is formed between grounding terminals.

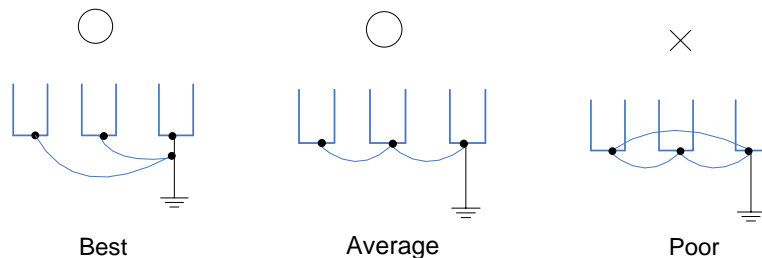

### 3.7.4 RFI filter

SE3 series inverters are equipped with built-in RFI filters. These filters are effective in reducing electromagnetic interference, but to meet CE standard, please refer to section 3.5.4 for installation and wiring.

#### ✓ Frame A/B

- ✓ \*1. Frame A : SE3-043-0.4~1.5K, SE3-023-0.4~1.5K, SE3-021-0.4~0.75K
- ✓ \*2. Frame B : SE3-043-2.2~3.7K, SE3-023-2.2~3.7K, SE3-021-1.5~2.2K

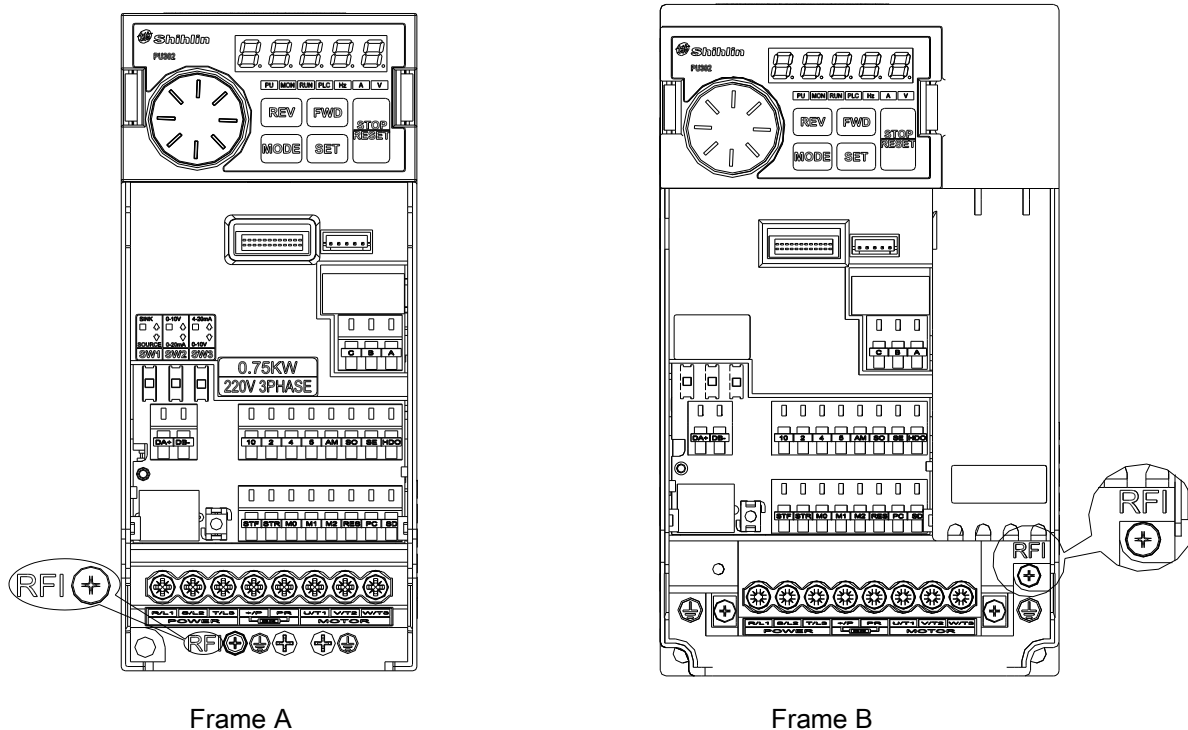

#### ✓ Frame C/D

- ✓ \*1. Frame C : SE3-043-5.5~11K, SE3-023-5.5~7.5K
- ✓ \*2. Frame D : SE3-043-15~22K, SE3-023-11~15K

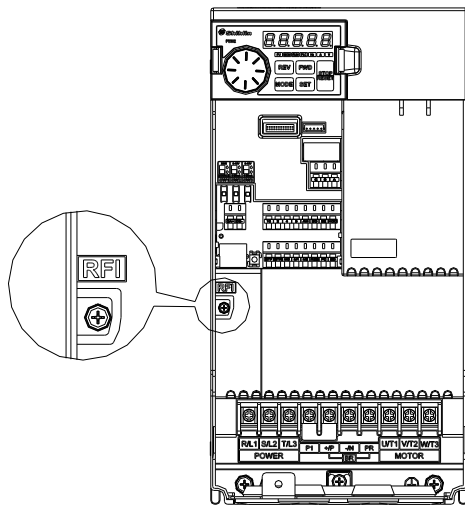

Frame C/D

RFI filter ON: screw is fastened (default status)

RFI filter OFF: screw is loosened

Note: 1. When the main power supply is switched on, DO NOT switch the status of the RFI filter. Confirm that the main power supply has been switched off before switching status of the RFI filter.

2. Electrical conductivity of the capacitor will be cut off by switching off the RFI filter. Moreover, the electromagnetic capacitance of the inverter will be reduced by switching off the RFI filter.

3. When one grounded power system is taken as the main power supply, DO NOT switch on the RFI filter. To prevent machine from damage, the RFI filter shall be cut off if the inverter is installed on an ungrounded power system, a high resistance-grounded (over 30 ohms) power system, or a corner grounded TN system.

4. DO NOT cut off the RFI filter during the high-voltage test.

5. When the RFI filter is ON, it can effectively suppress electromagnetic interference, but it also increases leakage current.

### 3.7.5 Control circuit

#### ✓ Control terminal name

Terminal type	Terminal name	Function instructions	Terminal specifications
Switch signal input	STF	These are multi-function control terminals, which can be switched between SINK/SOURCE mode.	Input impedance: 4.7kΩ Action current: 5mA(24VDC) Voltage range: 10~28VDC Maximum frequency: 1kHz
	STR		
	RES		
	M0	These are multi-function control terminals, which can be switched between SINK/SOURCE mode.	Maximum frequency: 33kHz
	M1		
	M2	This is a multi-function control terminal which can be switched between SINK/SOURCE mode. Compatible HDI function	Maximum frequency: 100kHz
Analog signal input	10	+10.5±0.5V	Maximum current:10mA
	2	-10~+10V、0~5V	Input impedance:10kΩ
	4	4~20mA/0~10V	When apply current the input impedance is 235Ω. When apply voltage the input impedance is 24kΩ.

## Terminal wire arrangement

Terminal type	Terminal name	Function instructions	Terminal specifications
Relay output	A	Multi-function relay output terminals. A-C is normal open contact, B-C is normal close contact, C is common terminal.	Maximum voltage: 30VDC or 250VAC Maximum current: Resistor load 5A NO/3A NC Inductance load 2A NO/1.2A NC ( $\cos\Phi=0.4$ )
	B		
	C		
Open collector output	SO	Multi-function open collector output terminal	Maximum voltage: 48VDC Maximum current: 50mA
	SE		
Analog signal output	AM	0~10V/0~20mA/4~20mA	Output voltage: 0~10VDC Maximum current: 3mA; Output current: 0~20mA Maximum load: 500Ω
Pulse output	HDO	Multi-function pulse output terminal, FM and 10X are compatible.	Minimum load:4.7kΩ Maximum current: 50mA Maximum voltage: 48VDC Maximum frequency: 100kHz
Communication terminal	DA+, DB-	RS485	Highest rate: 115200bps Longest distance: 500m
	RJ45		
Common terminal	SD	COM terminal for STF, STR, RES, M0, M1, M2,HDO (SINK).	---
	PC	COM terminal for STF, STR, RES, M0, M1, M2, HDO(SOURCE).	Output voltage: 24VDC±20% Maximum current: 200mA
	5	COM terminal for 10、2、4、AM	---

### ✓ Control logic (SINK/SOURCE) change

The multi-function digital input terminals on SE3 series inverter can be switched between sink and source by the toggle switch SW1. The diagram is as follows:



No matter which mode the multi-function digital input terminal is in, all of them can be considered as a simple switch. If the switch is “on”, the control signal will be applied into the terminal. If the switch is “off”, the control signal is shut off.

If “Sink Input” mode is selected, when the multi-function digital input terminal is short-circuited to SD or connected to an external PLC, the function of this terminal is valid. In this mode, the current flows from the corresponding terminal when it is short. Terminal “SD” is common terminal of the contact input signals. When the output transistor is powered by an external power supply, use PC terminal as a common terminal to prevent malfunction due to leakage current.

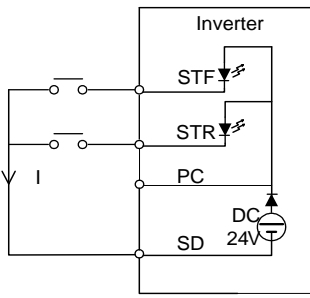

Sink Input: the multi-function control terminal is shorted directly with SD

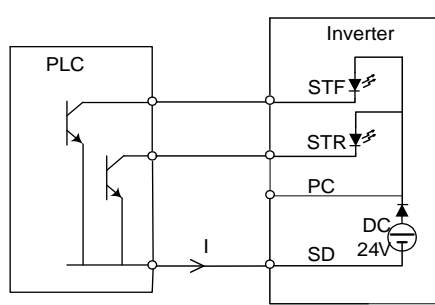

Sink Input: the multi-function control terminal is connected directly with open-collector PLC

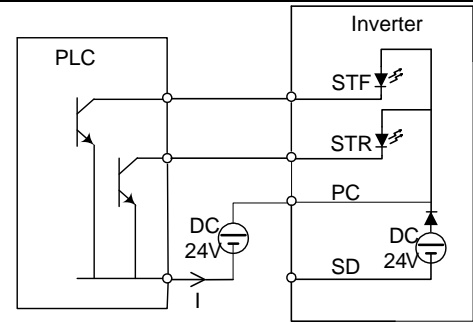

Sink Input: the multi-function control terminal is connected with open-collector PLC and external power supply

If "Source Input" mode is selected, when the multi-function digital input terminal is short-circuited to PC or connected to an external PLC, the function of this terminal is valid. In this mode, the current flows into the corresponding terminal when it is short. Terminal "PC" is common terminal of the contact input signals. When the output transistor is powered by an external power supply, use SD terminal as a common terminal to prevent malfunction due to leakage current.

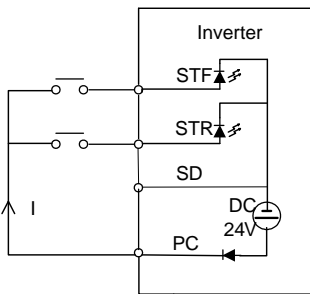

Source Input: the multi-function control terminal is shorted directly with PC

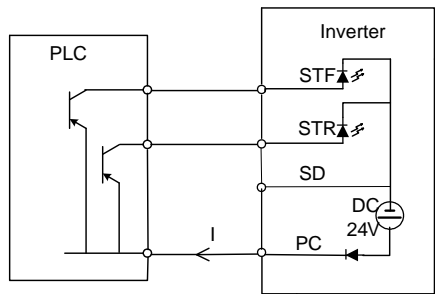

Source Input: the multi-function control terminal is connected directly with open-emitter PLC

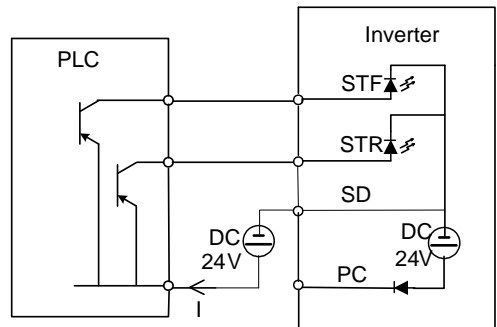

Source Input: the multi-function control terminal is connected with open-emitter PLC and external power supply

### ✓ Arrangement of control terminal

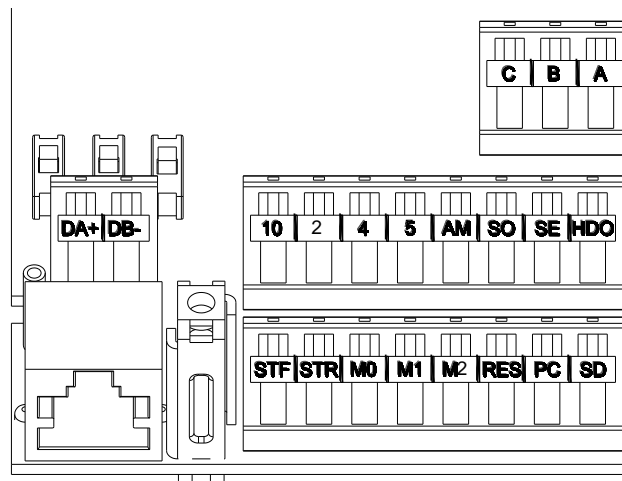

### ● Wires connection

For the control circuit wiring, strip off the sheath of a cable, and use it with a blade terminal. For a single wire, strip off the sheath of the wire and apply directly.

- (1) Strip off the sheath for the below length. If the length of the sheath peeled is too long, a short circuit may occur with neighboring wires. If the length is too short, wires might come off.

Wire the stripped cable after twisting it to prevent it from becoming loose. In addition, do not solder it.



## Terminal wire arrangement

### (2) Crimp the blade terminal.

Insert wires to a blade terminal, and check that the wires come out for about 0 to 0.5 mm from a sleeve.

Check the condition of the blade terminal after crimping. Do not use a blade terminal of which the crimping is inappropriate, or the face is damaged.

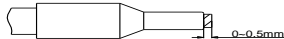

- Please do use blade terminals with insulation sleeve. Blade terminals commercially available:

Cable gauge (mm <sup>2</sup> )	Blade terminals model	L (mm)	d1 (mm)	d2 (mm)	Manufacturer	Crimping tool product number
0.3	AI 0,25-6 WH	10.5	0.8	2	Phoenix Contact Co., Ltd.	CRIMPFOX 6
0.5	AI 0,5-6 WH	12	1.1	2.5		
0.75	AI 0,75-6 GY	12	1.3	2.8		
0.75 (for two wires)	AI-TWIN 2×0,75-6 GY	12	1.3	2.8		

Note:1. Please Use a small flathead screwdriver (tip thickness: 0.6mm, width: 3.0mm). If a flathead screwdriver with a narrow tip is used, terminal block maybe damaged.

2. Tightening torque is 2.12~3.18 kgf.cm, too large tightening torque can cause screw slippage, too little tightening torque can cause a short circuit or malfunction.

- Wiring installation

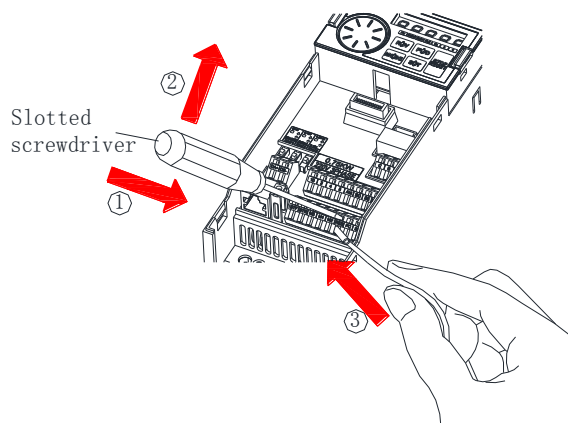

First insert slotted screwdriver with terminal blocks, pressing terminal blocks down, and then insert the electric wires.

- Wiring demounting

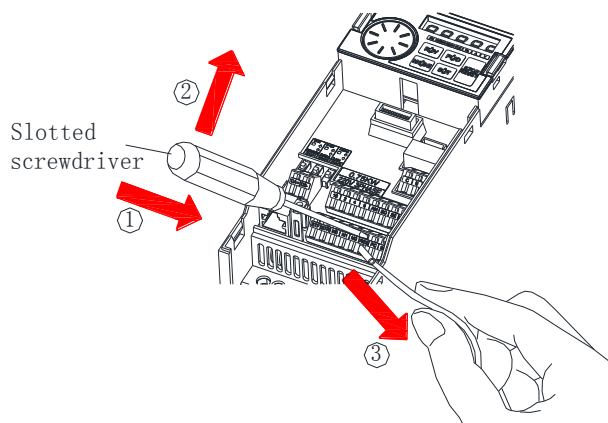





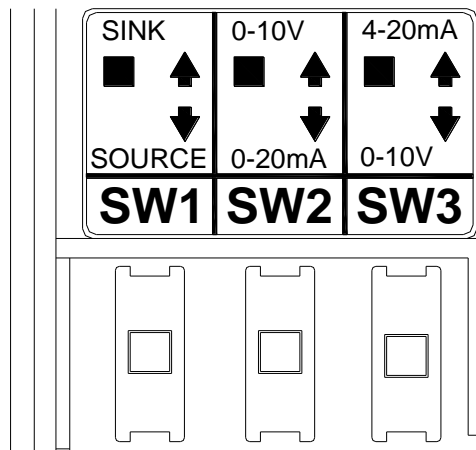

First insert slotted screwdriver with terminal blocks, and pressing terminal blocks down, and then pull out the wire.

Note: 1. Screwdriver, use small slotted screwdriver (the tip thickness: 0.4mm/tip width: 2.5mm).  
 2. If the screwdriver tip width is too narrow, it may cause terminal damage.  
 3. Please alignment terminals by pressing down with the slotted screwdriver, head sliding may cause damage or injury accident inverter.  
 4. Installation, wire arrangement, dismantling and maintenance can only be done by qualified electrical professional personnel.  
 5. Please follow the wire arrangement notice. If installation is not done by above steps, and inverter is damaged, our company will not undertake any legal responsibility. In case there is any question on the wire arrangement, please feel free to contact us.

✓ Toggle switch



Switch number	Switch state	Explanation	Remarks
SW1	 *	Select sink input mode	Please refer to section 3.7.5 control logic switch.
		Select source input mode	
SW2	 *	Output 0~10V voltage from terminal AM	Also requires setting 02-45, please refer to section 5.3.10.
		Output 0~20mA/4~20mA current from terminal AM	
SW3	 *	Input 4~20mA current signal into terminal 4-5	Also requires setting 02-20, please refer to section 5.3.6.
		Input 0~10V voltage signal into terminal 4-5	

Note: 1. The state with “\*” is the default state of switch.  
 2. The parts in black stand for switch handle.

### 3.8 Replacement procedure of fan

#### 3.8.1 Frame A/B

Frame A : SE3-043-0.4~1.5K, SE3-023-0.4~1.5K, SE3-021-0.4~0.75K

Frame B : SE3-043-2.2~3.7K, SE3-023-2.2~3.7K, SE3-021-1.5~2.2K

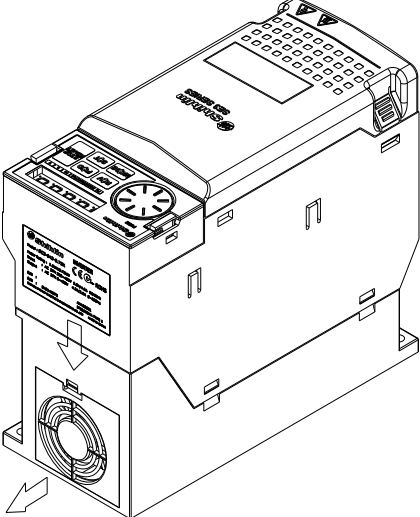
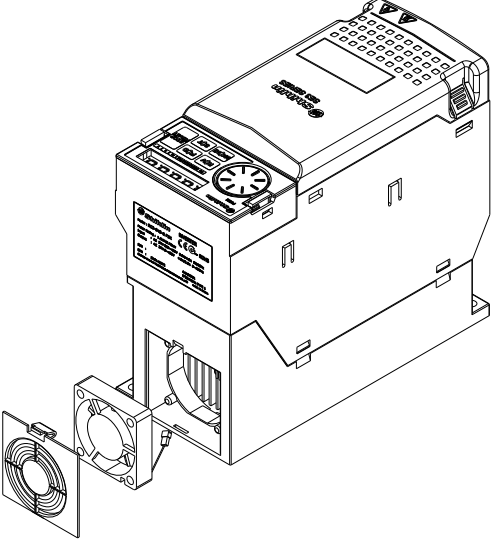
<p>1. Press the hooks on both side of the fan to remove the fan. (As shown below.)</p>	<p>2. Disconnect the power connector, and then remove the fan. (As shown below.)</p>
	

#### 3.8.2 Frame C/D

Frame C : SE3-043-5.5~11K, SE3-023-5.5~7.5K

Frame D : SE3-043-15~22K, SE3-023-11~15K

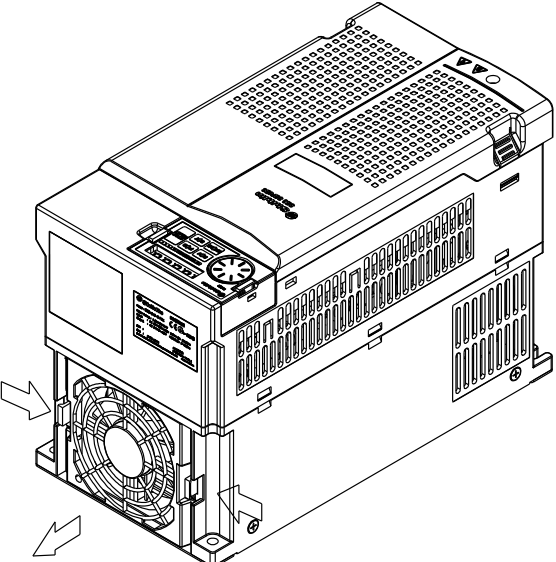
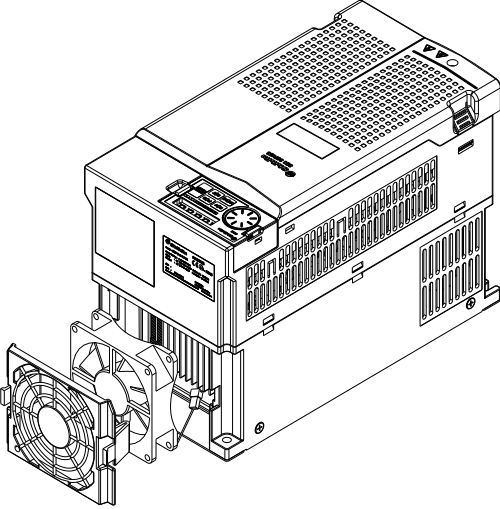
<p>1. Press the hooks on both side of the fan to remove the fan. (As shown below.)</p>	<p>2. Disconnect the power connector, and then remove the fan. (As shown below.)</p>
	



## 4. BASIC OPERATION

### 4.1 Component name of keypad (PU302)

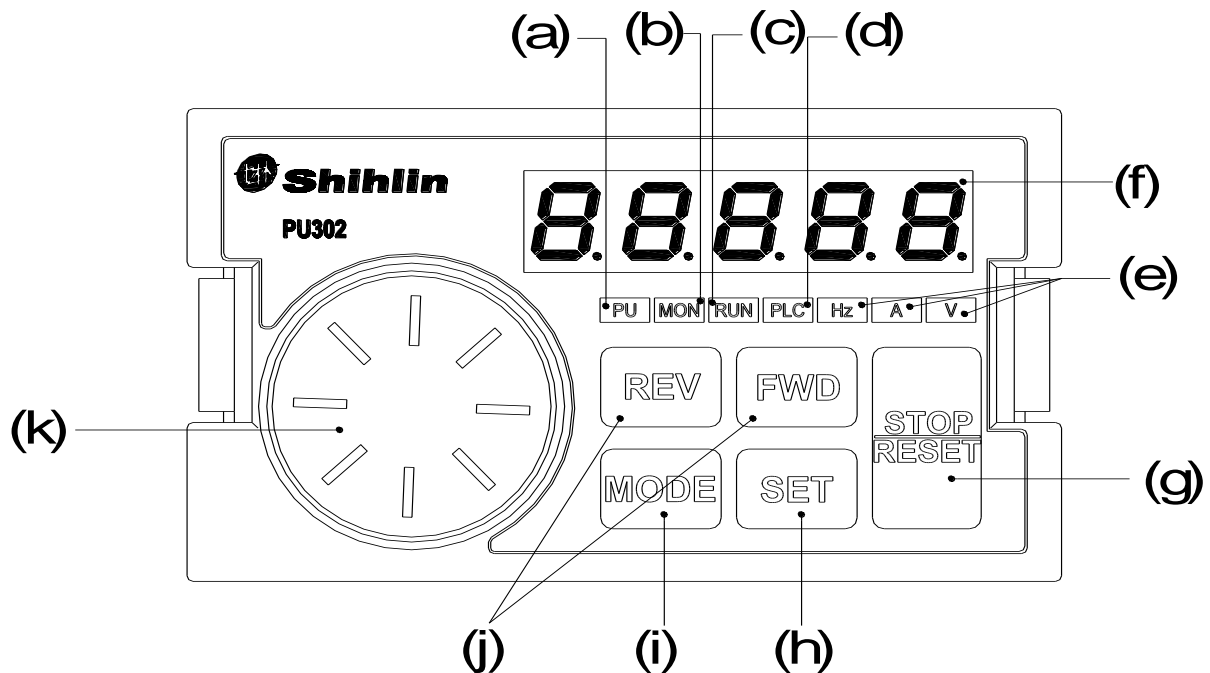

NO.	Operation parts	Name	Content
(a)		Operation mode indicator	PU: On when in PU and JOG operation mode, flickers in H1~H5 operation mode.
(b)		Keypad status indicator	MON: On to indicate the monitoring mode
(c)		RUN indicator	On when running
(d)		PLC function indicator	On when in PLC mode
(e)		Monitoring indicator	Hz: On when monitoring frequency. A: On when monitoring output current. V: On when monitoring output voltage by default. Can be set by 00-07 ( P.161 ) to monitor different values.
(f)		Monitor (5-digit LED)	Shows the frequency, parameter number, and parameter value, etc.
(g)		STOP/RESET button	Stops the operation. Resets the inverter when alarm.
(h)		SET button	Long press writes parameter value, frequency, etc. Press to read the parameter. Enter into the next menu.
(i)		MODE button	Switches to different modes
(j)		REV button    FWD button	REV: Starts reverse rotation. FWD: Starts forward rotation.
(k)		M Setting dial	Clockwise rotation increase values or can switch options Counter clockwise rotation decrease value or can switch options

Component name of keypad (PU302)

Note:

The HELP mode menu enter by pressing MODE button is shown as the table below:

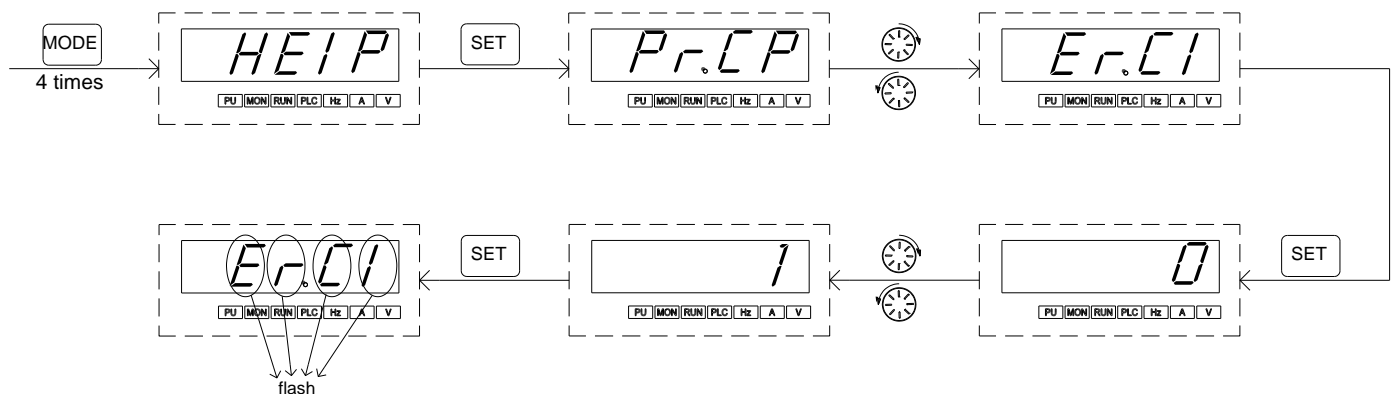

Menu	Name	Press SET button to enter into next function description
<i>P r . C P</i>	Parameter copy	0: Off 1: Copy the inverter parameter values into the keypad.
<i>P r . C A</i>	Parameter paste	0: Off 1: Paste the copied parameter values in keypad into the inverter (Please first set the inverter parameters to default, and then paste the parameter. This only works with same series same types inverter.)
<i>E r . C L</i>	Alarm clear	0: Off. 1: Clear all alarm and alarm information.
<i>r E S T</i>	Inverter reset	0: Off 1: Reset the inverter.
<i>A L L C</i>	Parameter set to default setting	0: Off 1: Part of inverter parameters are reset to default.
<i>P r . C r</i>	Part of parameters set to default	0: Off 1: Part of inverter parameters reset to default. 2: Inverter parameters reset to default + user parameters ( 15-00(P.900 ) ~15-19 (P.919) ) are not reset to default 3: Part of inverter parameters reset to default + user parameters ( 15-00(P.900) ~15-19(P.919) ) are not reset to default
<i>P r G r</i>	Parameter mode	0: P parameter mode 1: Parameter group mode
<i>P U _ F</i>	Auto write frequency selection	0: After changing frequency, the value will not write into the inverter automatically. 1: After changing frequency, the value will write into the inverter RAM after 0.5s and write into the inverter EEPROM after 10s automatically. 2: After changing frequency, the value will write into the inverter RAM after 0.5s and write into the inverter EEPROM after 30s automatically. 3: After changing frequency, the value will only write into the inverter RAM after 0.5s automatically.
<i>E . H I S</i>	Alarm record	Display the recent four alarm codes. (Read only)
<i>S n</i>	Inverter version	Display the version number of the inverter. (Read only)
<i>P U S n</i>	Keypad version	Display the version number of PU302. (Read only)

For example: Press MODE button to enter into HELP menu to Alarm clear *E r . C L*, the operation flow chart is as follows:



## 4.2 Operation modes of inverter

- Operation modes are related to signal source for the target frequency and signal source for motor starting. In Shihlin SE3 inverter there are ten kinds of operation modes, "PU mode  $PU$ ", "JOG mode  $JOG$ ", "external mode  $OPnd$ ", "communication mode  $CU$ ", "combined mode  $1H1$ ", "combined mode  $2H2$ ", "combined mode  $3H3$ ", "combined mode  $4H4$ " and "combined mode  $5H5$ " and second operation mode
- Use keypad to monitor output frequency, output voltage and output current, and view alarm message, set parameter and frequency. In keypad there are five work modes, "operation mode", "monitoring mode", "frequency setting mode" and "parameter setting mode" and "HELP mode".

Related parameters	Value	Operation mode	Signal source for target frequency	Signal source for motor starting	Remarks
Operation mode selection 00-16(P.79)	0	PU mode ( $PU$ )	 on keypad	FWD or REV button on keypad	"PU mode", "JOG mode" and "external mode" are interchangeable.
		JOG mode ( $JOG$ )	Set value of 01-13(P.15)	FWD or REV button on keypad	
		External mode ( $OPnd$ )	"External voltage/current signal", "multi-speed terminal" and external JOG (01-13(P.15)) Pulse input (03-05(P.82)) PG card A2 B2 (09-07(P.356))	External forward and reverse terminals	
			Frequency of each section in the programmed operation mode (04-19~04-26 / (P.131~P.138))	External STF terminal	
	1	PU mode ( $PU$ )	Equals to "PU mode" when 00-16(P.79) = 0		"PU mode" and "JOG mode" are interchangeable.
		JOG mode ( $JOG$ )	Equals to "JOG mode" when 00-16(P.79) = 0		
	2	External mode ( $OPnd$ )	Equals to "External mode" when 00-16(P.79) = 0		
	3	Communication mode ( $CU$ )	Communication		
	4	Combined mode 1 ( $H1$ )	 on keypad	External forward and reverse terminals	
	5	Combined mode 2 ( $H2$ )	"External voltage / current signal", "multi-speed terminals", frequency given by pulse (03-05 (P.82)), PG card A2/B2 (09-07(P.356))	FWD or REV button for PU parameter unit	
6	Combined mode 3 ( $H3$ )	Communication, "combination of multi-speed stage levels" and External JOG (01-13(P.15))	External forward and reverse terminals		
7	Combined mode 4 ( $H4$ )	"External voltage / current signal", "combination of multi-speed stage levels", frequency given by pulse (03-05(P.82))	Communication		
8	Combined mode 5 ( $H5$ )	 on keypad, "combination of multi-speed stage levels" and External JOG (01-13(P.15))	External forward and reverse terminals		
99999	Second operation mode ( $refe$ )	Set by 00-17(P.97)	Sets by 00-18(P.109)		

- When 00-16(P.79) = 0, the external mode ( $OPnd$ ) is the default mode after inverter is turned on. Use 00-16(P.79) to switch the operation mode.

### 4.2.1 Flow chart for switching operation mode

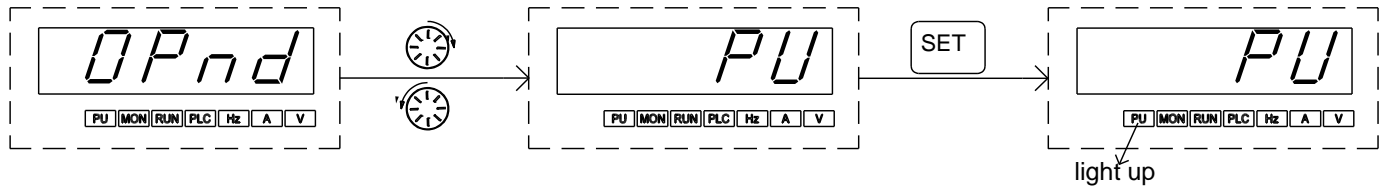

- Note: 1. In “PU mode”, keypad screen displays *PU*, and the indicator in **PU** will light up.  
 2. In “external mode”, keypad screen displays *OPnd*,  
 3. In “combined mode 1, 2, 3, 4, or 5”, the indicator in **PU** will flash on the keypad screen.  
 4. In “JOG mode”, the indicator in **PU** will light up.  
 5. No flow chart when 00-16(P.79) is set to =2, 3, 4, 5, 6, 7 or 8 because the operation mode will not switch

### 4.2.2 Flow chart for switching working mode with PU302 keypad

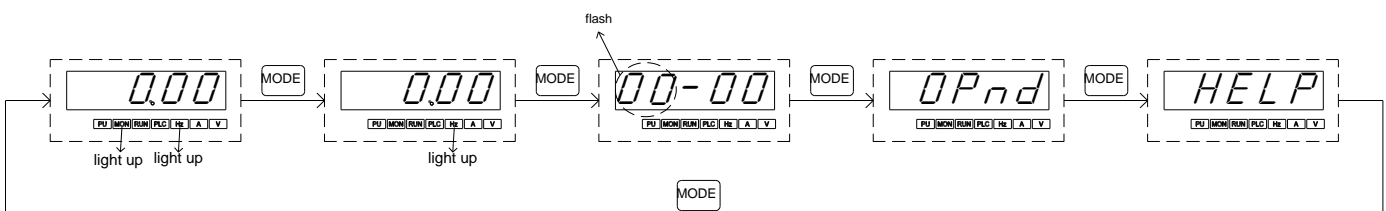

- Note: 1. Please refer to section 4.2.3 for detailed operation steps under monitoring mode.  
 2. Please refer to section 4.2.4 for detailed operation steps under frequency setting mode.  
 3. Please refer to section 4.2.5 for detailed operation steps under parameter setting mode.  
 4. Please refer to Section 4.2.1 for detailed operation steps under switching operation mode.

### 4.2.3 Operation flow charts for monitoring mode with PU302 keypad

•Take PU mode for example:

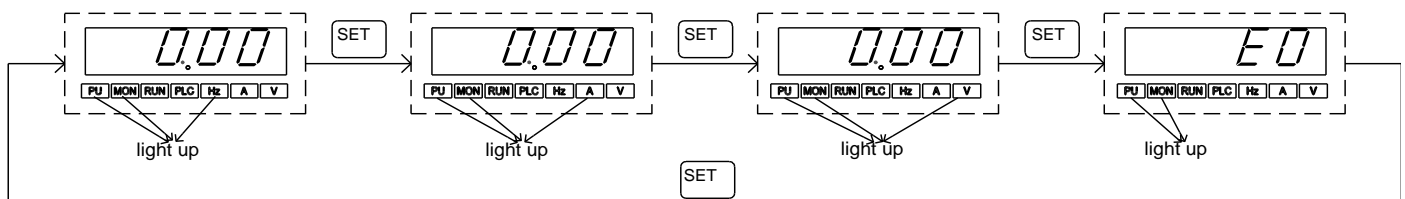

- Note: 1. In “monitoring output frequency” mode, indicator in **MON** and **Hz** will light up, and the screen will display current output frequency.  
 2. In “monitoring output voltage” mode, indicator in **MON** and **V** will light up, and the screen will display current output voltage.  
 3. In “monitoring output current” mode, indicator in **MON** and **A** will light up, and the screen will display current output current.  
 4. When in “browsing alarm record” mode, indicator in **MON** will light up, and the screen will display current alarm code.  
 5. For alarm codes, please refer to Appendix 2.

#### 4.2.4 Operation flow charts for frequency setting mode with PU302

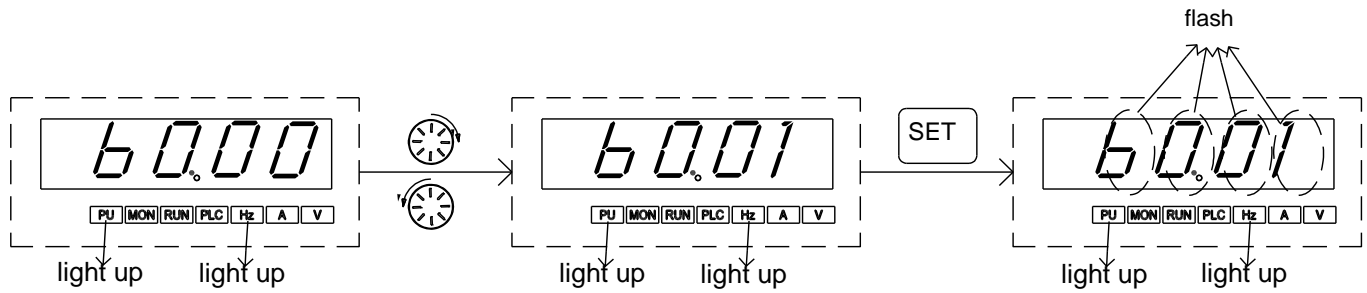

Note: 1. Use  to change the frequency when the inverter is running.  
 2. Under frequency setting mode, indicator in **Hz** will light up, but **MON** will NOT light up.  
 3. When setting frequency under PU mode, the set value cannot exceed the upper frequency. When high frequency is needed, the upper frequency should be changed first.

#### 4.2.5 Operation flow charts for parameter setting mode with PU302

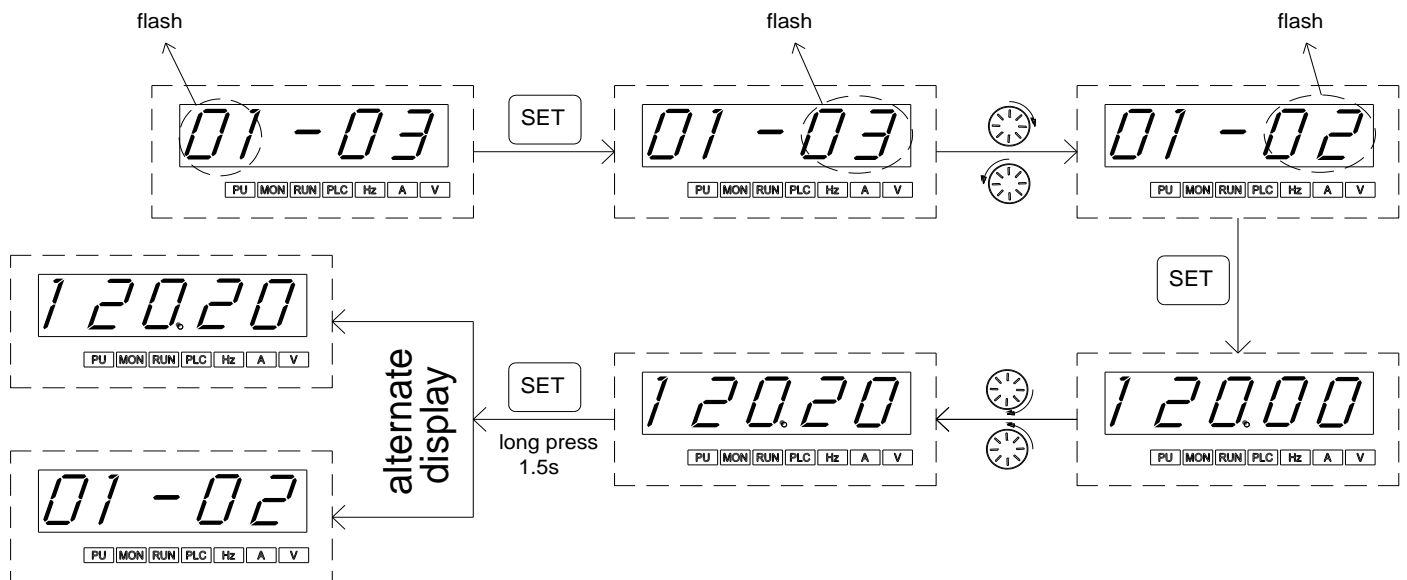

Note: Indicator in **Hz** and **MON** will NOT light up under parameter setting mode. Be sure to hold **SET** key and keep it above 1.5s

### 4.3 Basic operation steps for different modes

#### 4.3.1 Basic operation steps for PU mode (00-16(P.79) = 0 or 1)

Step	Description
1	<ul style="list-style-type: none"> <li>Switch operation mode to PU mode, and indicator in <b>PU</b> will light up.</li> </ul> <p>Note: 1. When 00-16(P.79) =0, the inverter will first be in external mode after power on or reset. 2. For selecting and switching operation mode, please refer to section 4.2.</p>
2	<ul style="list-style-type: none"> <li>Enter frequency setting mode and write target frequency into memory.</li> </ul> <p>Note: For detailed setting procedures, please refer to section 4.2.4.</p>
3	<ul style="list-style-type: none"> <li>Press <b>FWD</b> or <b>REV</b> to run the motor. At this point, indicator in <b>RUN</b> will flash to indicate that the motor is running. The keypad will automatically switch to monitor mode and display the current output frequency.</li> </ul> <p>Note: 1. For detailed operation steps for monitoring mode, please refer to section 4.2.3. 2. While the motor is running, the user can enter frequency setting mode to change target frequency for regulating the motor speed.</p>
4	<ul style="list-style-type: none"> <li>Press <b>STOP/RESET</b> and the motor will begin to decelerate until it comes to a full stop.</li> <li>Indicator in <b>RUN</b> will not turn off until the inverter stops outputting voltage</li> </ul>

#### 4.3.2 Basic operation steps for external mode (00-16(P.79) = 0 or 2)

Step	Description
1	<ul style="list-style-type: none"> <li>Switch operation mode to external mode, screen will display <b>SPnd</b></li> </ul> <p>Note: 1. When 00-16(P.79) =0, after power on or reset, press <b>MODE</b> to switch to operation mode, inverter will first switch to external mode, then use  to switch to PU mode;. 2. When 00-16(P.79) =2, inverter will always be in external mode ; 3. For selecting and switching operation mode, please refer to section 4.2.</p>
2	<ul style="list-style-type: none"> <li>Target frequency is set by external terminals (default priority from high to low):</li> <li>If program operating mode is chosen, please refer to section 5.4.1 function selection of digital input and 5.5.2 programmed operation mode.</li> <li>If target frequency is set by multi-speed stage levels, please refer to <a href="#">section 5.5.1 16 speed stage levels</a>.</li> <li>If target frequency is set by PG card A2/B2, please refer to <a href="#">section 5.10.4 PG2 parameters</a></li> <li>If target frequency is set by PWM pulse input, please refer to <a href="#">section 5.4.1 function selection of digital input</a>.</li> <li>If target frequency is set by input signal across terminal 2-5, please refer to <a href="#">section 5.3.5 input selection and operation across terminal 2-5</a></li> <li>If target frequency is set by input signal across terminal 4-5, please refer to <a href="#">section 5.3.6 input selection and operation across terminal 4-5</a></li> <li>If target frequency is set by high-speed pulse input across terminal M2, please refer to <a href="#">section 5.3.7 HDI input selection and processing</a></li> </ul>
3	<ul style="list-style-type: none"> <li>Turn on STF or STR to run the motor.</li> <li>At this point, indicator in <b>RUN</b> will flash, indicating that the motor is running.</li> </ul> <p>Note: 1. For setting up the starting terminals STF and STR, please refer to <a href="#">section 5.1.8 prevention selection of forward/reverse rotation</a> and 5.4.1 function selection of digital input. 2. For detailed operation steps for the monitor mode, please refer to section 4.2.3. 3. If programmed operation mode is chosen, then STF and STR will become the starting signal and the pause signal, instead of being forward or reverse terminals.</p>
4	<ul style="list-style-type: none"> <li>Turn off STF or STR to decelerate the motor until it comes to a full stop.</li> <li>Indicator in <b>RUN</b> will not turn off until the inverter stops outputting voltage.</li> </ul>

## 4.3.3 Basic operation steps for JOG mode (00-16(P.79) = 0 or 1)

Step	Description
1	<ul style="list-style-type: none"> <li>Switch operation mode to JOG mode and indicator in <b>PU</b> will light up, the display shows <math>\frac{1}{00}</math>.</li> </ul> <p>Note: 1. For detailed operating procedures for the monitor mode, please refer to section 4.2.</p>
2	<ul style="list-style-type: none"> <li>Press <b>FWD</b> or <b>REV</b> to run the motor. At this point, indicator in <b>RUN</b> will glitter, indicating that the motor is running.</li> <li>Release <b>FWD</b> or <b>REV</b> to decelerate the motor until it comes to a full stop. Indicator in <b>RUN</b> will not turn off until the inverter stops the output.</li> </ul> <p>Note: 1. For detailed operating procedures for monitor mode, please refer to section 4.2.3. 2. In JOG mode, target frequency is the value of 01-13(P.15), and the acceleration / deceleration time is the value of 01-14(P.16). Please refer to <b>section 5.2.7 JOG operation</b></p>

## 4.3.4 Basic operation steps for communication mode (00-16(P.79) = 3)

- ◆ In communication mode, user can set parameters and run/stop or reset inverters by communication. Please refer to Communication function related parameters for details.

## 4.3.5 Basic operation steps for combined mode 1 (00-16(P.79) = 4)

Step	Description
1	<ul style="list-style-type: none"> <li>In Combined Mode 1, indicator <b>PU</b> will light up.</li> </ul> <p>Note: 1. For detailed operation procedures for monitor mode, please refer to section 4.2.</p>
2	<ul style="list-style-type: none"> <li>Enter frequency setting mode and write target frequency into memory.</li> </ul> <p>Note: For setting details, please refer to section 4.2.4.</p>
3	<ul style="list-style-type: none"> <li>Set target frequency by PU302 keypad and start the inverter by digital input terminals.</li> <li>At this point, indicator in <b>RUN</b> will flash, indicating that the motor is running.</li> </ul> <p>Note: For detailed operation procedures for monitor mode, please refer to section 4.2.3.</p>
4	<ul style="list-style-type: none"> <li>When digital input terminals output stop signals, motor will decelerate until it comes to a full stop.</li> <li>Indicator in <b>RUN</b> will not turn off until the inverter stops outputting.</li> </ul>

#### 4.3.6 Basic operation steps for combined mode 2 (00-16(P.79) = 5)

Step	Description
1	<ul style="list-style-type: none"> <li>In Combined Mode 2, indicating lamp <input type="checkbox"/> PU will light up.</li> </ul> <p>Note: For selecting and switching the operation mode, please refer to Section 4.2.</p>
2	<ul style="list-style-type: none"> <li>Target frequency is set by external terminals (default priority from high to low):</li> <li>If the programmable operating mode is chosen, please refer to section 5.4.1 function selection of digital input and 5.5.2 programmed operation mode.</li> <li>If target frequency is set by multi-speed stage levels, please refer to <a href="#">section 5.5.1 16 speed stage levels</a>.</li> <li>If target frequency is set by pulse signal across terminal A2/B2 on PG card, please refer to <a href="#">section 5.10.4 PG2 parameters</a>.</li> <li>If target frequency is set by PWM input pulse, please refer to <a href="#">section 5.4.1 function selection of digital input</a>.</li> <li>If target frequency is set by the input signal across terminal 2-5, please refer to <a href="#">section 5.3.5 input selection and operation across terminal 2-5</a>.</li> <li>If target frequency is set by the input signal across terminal 4-5, please refer to <a href="#">section 5.3.6 input selection and operation across terminal 4-5</a>.</li> <li>If target frequency is set by high-speed pulse input across terminal M2, please refer to <a href="#">section 5.3.7 HDI input selection and processing</a>.</li> </ul>
3	<ul style="list-style-type: none"> <li>Press <input type="checkbox"/> FWD or <input type="checkbox"/> REV on keypad to run the motor. At this point, indicator <input type="checkbox"/> RUN will flash, indicating that the motor is running.</li> </ul> <p>Note: 1. For detailed operation procedures for monitoring mode, please refer to section 4.2.3. 2. While the motor is running, user can enter frequency setting mode to change the target frequency for regulating motor speed.</p>
4	<ul style="list-style-type: none"> <li>Press <input type="checkbox"/> STOP RESET and the motor will begin to decelerate until it comes to a full stop.</li> <li>Indicator <input type="checkbox"/> RUN will not turn off until the inverter stops outputting.</li> </ul>

#### 4.3.7 Basic operation steps for combined mode 3(00-16(P.79) = 6)

Step	Description
1	<ul style="list-style-type: none"> <li>In Combined Mode 3, indicator in <input type="checkbox"/> PU will flash.</li> </ul> <p>Note: 1. For detailed operation procedures for monitor mode, please refer to section 4.2.</p>
2	<ul style="list-style-type: none"> <li>The default priority is from high to low:</li> <li>When external JOG is "on", target frequency is determined by 01-13(P.15). Acceleration / deceleration time is set by the value of 01-14(P.16).</li> <li>When M0, M1, M2 and REX of multi-speed stage levels are "on", target frequency is determined by combination of multi-speed stage levels (Please refer to section 5.5.1 16 speed stage levels)</li> <li>Target frequency is determined by communication:</li> </ul>
3	<ul style="list-style-type: none"> <li>The inverter starting is activated by the external STF/STR terminals. At this point, indicator <input type="checkbox"/> RUN will flash, indicating that the motor is running.</li> <li>Functions of 00-02(P.996~P.999) can be accomplished by communication.</li> </ul> <p>Note: For detailed operation procedures for the monitor mode, please refer to Section 4.2.3.</p>
4	<ul style="list-style-type: none"> <li>When the digital input terminals STF STR turn off, motor will decelerate until it comes to a full stop.</li> <li>Indicator <input type="checkbox"/> RUN will not turn off until the inverter stops outputting.</li> </ul>



## 4.3.8 Basic operation steps for combined mode 4(00-16(P.79) = 7)

Step	Description
1	<ul style="list-style-type: none"> <li>In Combined Mode 4, indicator in <input type="checkbox"/> PU will flash.</li> </ul> <p>Note: 1. For detailed operation procedures for monitor mode, please refer to Section 4.2.</p>
2	<ul style="list-style-type: none"> <li>Target frequency is set by the external terminals (the default priority is from high to low)</li> <li>If the programmable operating mode is chosen, please refer to section 5.4.1 function selection of digital input and 5.5.2 programmed operation mode.</li> <li>If target frequency is set by multi-speed stage levels, please refer to section 5.5.1 16 speed stage levels.</li> <li>If target frequency is set by pulse signal across terminal A2/B2 on PG card, please refer to section 5.10.4 PG2 parameters.</li> <li>If target frequency is set by PWM input pulse, please refer to section 5.4.1 function selection of digital input.</li> <li>If target frequency is set by the input signal across terminal 2-5, please refer to section 5.3.5 input selection and operation across terminal 2-5.</li> <li>If target frequency is set by the input signal across terminal 4-5, please refer to section 5.3.6 input selection and operation across terminal 4-5.</li> <li>If target frequency is set by high-speed pulse input across terminal M2, please refer to section 5.3.7 HDI input selection and processing.</li> </ul>
3	<ul style="list-style-type: none"> <li>Inverter starting is activated by communication (including "Reset"). At this point, indicator <input type="checkbox"/> RUN will flash indicating that the motor is running.</li> </ul> <p>Note: 1. For detailed operation procedures for the monitoring mode, please refer to Section 4.2.3. 2. While the motor is running, user can enter into frequency setting mode to change the target frequency for regulating motor speed.</p>
4	<ul style="list-style-type: none"> <li>When communication sends stop command, the motor will decelerate until it comes to a full stop.</li> <li>Indicator <input type="checkbox"/> RUN will not turn off until the inverter stops the output.</li> </ul>

## 4.3.9 Basic operation steps for combined mode 5(00-16(P.79) = 8)

Step	Description
1	<ul style="list-style-type: none"> <li>In Combined Mode 5, indicator <input type="checkbox"/> PU will light up.</li> </ul> <p>Note: For detailed operating procedures for monitor mode, please refer to Section 4.2.</p>
2	<ul style="list-style-type: none"> <li>Default priority is from high to low</li> <li>When external JOG is "on", target frequency is determined by the value in 01-13(P.15). Acceleration / deceleration time is set by the value in 01-14(P.16).</li> <li>When M0, M1, M2 and REX for multi-speed stage levels are "on", target frequency is determined by the combination of multi-speed stage levels (please refer to section 5.5.1 16 speed stage levels).</li> <li>Target frequency of the inverter is set by keypad PU302</li> </ul>
3	<ul style="list-style-type: none"> <li>Inverter starting is triggered by external STF or STR terminals.</li> </ul> <p>Note: 1. For detailed operation procedures for the monitoring mode, please refer to section 4.2.3. 2. While the motor is running, the user can enter frequency setting mode to change the target frequency for regulating motor speed.</p>
4	<ul style="list-style-type: none"> <li>When the digital input terminals STF STR turn off, motor will decelerate until it comes to a full stop.</li> <li>Indicator <input type="checkbox"/> RUN will not turn off until inverter stops output.</li> </ul>

## 4.3.10 Basic operation procedures for the second operation mode(00-16(P.79) = 99999)

- ◆ In second operation mode, target frequency is determined by 00-17(P.97), and the run command is determined by 00-18(P.109), please refer to Section 5.1.9 Operation mode selection for related description and Section 4.3.1~4.3.5 for related operation method.

## 4.4 Operation

### 4.4.1 Check and preparation before running

Before running, the following shall be checked:

1. Check if the wiring is correct. Inverter output terminals (U/T1, V/T2, W/T3) cannot be connected to the power. Confirm that grounding terminal (⊕) is well grounded.
2. Confirm that there is no short circuit or short circuit to ground between the terminals or each exposed live part.
3. Confirm all terminal connections, and check if plug connectors (optional) and screws are all fastened.
4. Confirm that the motor is not connected to any load or mechanism.
5. All external switches are in off state before the power is turned on. When the power is turned on, the inverter will not start and no abnormal action will occur.
6. Turn on the power only after the cover is well placed.
7. Do not touch the switch with wet hands.
8. Make sure the following after power on:

No alarm on PU302 keypad, both indicator in  and  will light up.

### 4.4.2 Running methods

For every running method, please refer to basic operation procedures in chapter 4 and parameter description in chapter 5. Select the most appropriate operation methods according to the application requirements and regulations. The most commonly used operation methods are shown below:

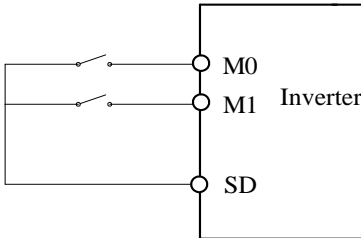
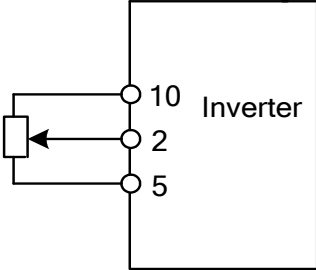



Operation method	Source of the target frequency	Source of the operating signal
keypad operation		<input type="text" value="FWD"/> or <input type="text" value="REV"/>
External terminal signal operation	 <p style="text-align: right;">Inverter</p> <p>Parameter Setting : 04-01(P.5)=30 04-02(P.6)=10</p>	Input by digital input terminal: STF-SD STR-SD
	 <p style="text-align: right;">Inverter</p> <p style="text-align: center;">2-5 terminal input</p>	

### 4.4.3 Test run

Check cables and abnormalities before the test run. After power on, the inverter is in external mode.

1. After power on, no alarm on PU302 keypad, make sure power indicator and  is on.
2. Connect a switch between STF and SD or STR and SD.
3. Connect a potentiometer between 2-5-10 or provide 0~5V dc between 2 and 5.
4. Adjust potentiometer or 0~5V dc to a minimum value (under 1V).
5. If STF is on, forward rotation is activated. If STR is on, reverse rotation is activated. Turn off STF or STR to decelerate the motor until it stops completely.
6. Check the following:
  - 1). Whether the direction of motor rotation is correct.
  - 2). Whether the rotation is smooth (check for noise and vibration).
  - 3). Whether the acceleration / deceleration is smooth.

If there is an optional keypad, do the following:

1. Make sure the keypad is connected to the inverter properly.
2. Change the operation mode to PU mode after power on, and the screen will display 50/60Hz.
3. Press  button to set the target frequency at about 5Hz.
4. Press  for forward rotation and  for reverse rotation. Press  to decelerate the motor until it stops completely.
5. Check the following:
  - 1) Whether the direction of motor rotation is correct.
  - 2) Whether the rotation is smooth (check for noise and vibration).
  - 3) Whether the acceleration / deceleration is smooth.

If it runs successfully, continue the test run by increasing the frequency and go through the above procedure.

After confirming that there are no abnormalities, it can be put into operation.

Note: If the operation of the inverter and motor is abnormal, stop the operation immediately and check the cause of the abnormality according to "Troubleshooting". After the inverter stops outputting, **if** the main circuit power terminals R/L1, S/L2, T/L3 are not disconnected, if the inverter's output terminals U/T1, V/T2, W/T3 are touched, it may cause an electric shock. In addition, even if the main loop power supply is turned off, it takes a certain time for the capacitor to discharge. After the main circuit power is cut off, wait until the power indicator is off, and measure the DC circuit voltage with a voltmeter to confirm that it has drop below the safe voltage level before touching the internal circuit of the inverter.

## 5. PARAMETER DESCRIPTION

### 5.1 System parameter group 00

Group	Parameter Number	Name	Setting Range	Default	Page
00-00	P.90	Inverter model	Read only	Read only	<a href="#">62</a>
00-01	P.188	Firmware version	Read only	Read only	<a href="#">62</a>
00-02	P.996 ~ P.999	Parameter restoration	0: Off	0	<a href="#">63</a>
			1: Clear alarm history (P.996=1)		
			2: Reset inverter (P.997=1)		
			3: Restore all parameters to default (P.998=1)		
			4: Restore some parameters to default 1 (P.999=1)		
			5: Restore some parameters to default 2 (P.999=2)		
6: Restore some parameters to default 3 (P.999=3)					
00-03	P.77	Selection of parameters write protection	0: Parameters can be written only when the motor stops.	0	<a href="#">65</a>
			1: Parameters cannot be written.		
			2: Parameters can also be written when the motor is running.		
3: Parameters cannot be read when in password protection.					
00-04	P.294	Password parameter	0~65535	0	<a href="#">65</a>
00-05	P.295	Password setup	2~65535	0	<a href="#">65</a>
00-06	P.110	Keypad monitor selection	X0: When inverter starts, keypad enters monitor mode automatically, screen displays output frequency.	1	<a href="#">69</a>
			X1: When inverter starts, screen displays steady state frequency.		
			X2: When inverter starts, keypad enters monitor mode automatically, screen displays current pressure and feedback pressure of the constant pressure system in percentage		
			X5 : When inverter starts, keypad enters monitor mode automatically, screen displays current pressure and feedback pressure of the constant pressure system		
			0X : Boot screen monitors output frequency		
			1X : Boot screen is in target frequency setting mode		
			2X : Boot screen monitors output current		
			3X : Boot screen monitors output voltage		
00-07	P.161	Multi-function display	0: Output AC voltage (V)	0	<a href="#">69</a>
			1: Voltage between (+/P) and (-/N) terminals. (V)		
			2: Inverter temperature rising accumulation rate (%)		
			3: Target pressure of the constant pressure system (%)		
			4: Feedback pressure of the constant pressure system (%)		

Group	Parameter Number	Name	Setting Range	Default	Page
00-07	P.161	Multi-function display	5: Running frequency (Hz)	0	69
			6: Electronic thermal accumulation rate (%)		
			7: Signal value (V) of 2-5 input terminals.		
			8: Signal value (mA) of 4-5 input terminals (mA/V).		
			9: Output power (kW).		
			10: PG card feedback rotation speed. (Hz)		
			11: Forward reverse rotation signal. 1: forward rotation 2: reverse rotation 0: stop.		
			12: NTC temperature (°C)		
			13: Motor electronic thermal accumulation rate (%)		
			14: Reserved.		
			15: Input frequency of terminal M2. (kHz)		
			16: Real-time roll diameter. (mm)		
			17: Real-time line speed. (m/min)		
			18: Output torque of inverter (%) (Valid only when 00-21 (P. 300) or 00-22 (P. 370) is set to 3 ~ 6 )		
			19: Digital terminal input state		
			20: Digital terminal output state		
			21: Actual working carrier frequency		
			22: Reserved		
			23: Synchronous motor rotor pole position ( Show motor rotor magnetic pole position from encoder feedback, valid when 00-21 (P. 300) = 5)		
			24: Current target frequency		
			25: PTC input percentage		
			26: Target pressure and feedback pressure from the constant pressure system		
			27: Motor rotation speed		
28: Power factor					
29: Power accumulation rate (kWh)					
30: PG feedback rotation speed					
31: Motor rotor position (Z pulse as 0)					
32: PG card feedback A1 B1 pulse count					
33: PG card feedback A2 B2 pulse count					
00-08	P.37	Speed display	0: Display output frequency(not mechanical speed)	0.0	70
			1~50000		
			1~9999		
00-09	P.259	Multi-function display unit selection	X0: Speed display unit is 1	1	70
			X1: Speed display unit is 0.1		
			0X: Power accumulation rate unit is 1		
			1X: Power accumulation rate unit is 0.1		
			2X: Power accumulation rate unit is 0.01		
00-11	P.72	Carrier frequency	1~15KHz	5 kHz	70
00-12	P.31	Soft-PWM carrier function selection	0: Off	0	70
			1: When 00-11(P.72)< 5, Soft-PWM is on (only apply to V/F control )		
00-13	P.71	Idling brake / DC brake	0: Idling brake	1	71
			1: DC brake		

System parameter group 00

Group	Parameter Number	Name	Setting Range	Default	Page
00-14	P.75	Stop function selection	0: Press STOP button and inverter stop running in PU and H2 mode	1	<u>71</u>
			1: Press STOP button and inverter stop running in all mode.		
00-15	P.78	Prevent forward/reverse rotation selection	0: Forward/reverse rotation are both permitted.	0	<u>72</u>
			1: Prevent reverse rotation (Giving reverse signal decelerates and stops the motor).		
			2: Prevent forward rotation (Giving forward signal decelerates and stops the motor).		
00-16	P.79	Operation mode selection	0: "PU mode", "external mode" and "Jog mode" are interchangeable.	0	<u>72</u>
			1: "PU mode" and "JOG mode" are interchangeable.		
			2: "External mode" only		
			3: "Communication mode" only		
			4: "Combined mode 1"		
			5: "Combined mode 2"		
			6: "Combined mode 3"		
			7: "Combined mode 4"		
			8: "Combined mode 5"		
99999: Second operation mode, run command is set by 00-18(P.109), target frequency is set by 00-17(P.97)					
00-17	P.97	Second target frequency selection	0: Frequency set by keypad	0	<u>73</u>
			1: Frequency set by RS485 communication		
			2: Frequency set by analog input		
			3: Frequency set by communication expansion card		
			4: Frequency set by PG card A2 B2		
5: Frequency set by HDI pulse					
00-18	P.109	Second start signal selection	0: Start signal set by keypad	0	<u>73</u>
			1: Start signal set by digital input terminal		
			2: Start signal set by RS485 communication		
			3: Start signal set by communication expansion card		
00-19	P.35	Communication mode selection	0: In communication mode, run signal and frequency is given by communication.	0	<u>73</u>
			1: In communication mode, run signal and frequency is given by external signal.		
00-20	P.400	Control mode selection	0: Speed control	0	<u>73</u>
			1: Torque control		
			2: Position control		
00-21	P.300	Motor control mode selection	0: Induction motor V/F control	0	<u>74</u>
			1: Induction motor closed-loop V/F control (VF + PG)		
			2: Induction motor simple vector control		
			3: Induction motor sensorless vector control		
			4: Induction motor PG vector control		
			5: Synchronous motor PG vector control		
6: Synchronous motor vector control without PG					

Group	Parameter Number	Name	Setting Range	Default	Page
00-22	P.370	Second motor control mode selection	0: Induction motor V/F control	99999	<u>74</u>
			1: Induction motor close-loop V/F control (VF+PG)		
			2: Induction motor simple vector control		
			3: Induction motor sensorless vector control		
			4: Induction motor PG vector control		
			5: Synchronous motor PG vector control		
			6: Synchronous motor vector control without PG		
	99999: Off				
00-23	P.186	Motor types selection	0: Normal Duty (ND), on fan and pump duty type.	1	<u>75</u>
			1: Heavy Duty (HD), apply to other duties.		
00-24	P.189	50Hz/60Hz switch selection	0: Frequency related parameter default value is 60Hz.	0	<u>75</u>
			1: Frequency related parameter default value is 50Hz.	1	
00-25	P.990	Parameter display mode setting	0: Parameter is displayed in "group mode"	0	<u>76</u>
			1: Parameter is displayed in "P parameter mode"		
00-26	P.125	Expansion card type	Read only	Read only	<u>76</u>
00-27	P.991	Frequency mode setting	0: Normal mode	0	<u>76</u>
			1: High speed mode		

5.1.1 Inverter information

➤ For checking inverter model, control board firmware version, and the connected expansion card, etc.

Parameter	Name	Default	Setting Range	Content
00-00 P.90	Inverter model	Read only	Read only	---
00-01 P.188	Firmware version	Read only	Read only	Inverter control board firmware version

◆ Inverter model

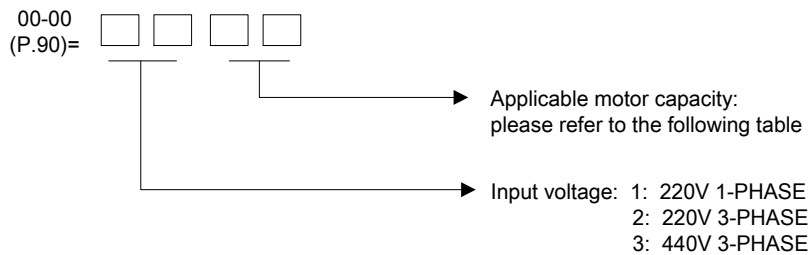

Read Applicable motor capacity:

Value(value of the two low-order bits of 00-00(P.90))	Capacity (kW)
2	0.4
3	0.75
4	1.5
5	2.2
6	3.7
7	5.5
8	7.5
9	11
10	15
11	18.5
12	22

Note: The parameters above are read only, not for write.



## 5.1.2 Parameter restoration

➤ Set parameters back to default.

Parameter	Name	Default	Setting Range	Content
00-02(P.996~P.999)	Parameter restoration	0	0	Off
			1	Clear alarm history (P.996=1)
			2	Reset inverter (P.997=1)
			3	All parameters restore to default (P.998=1)
			4	Some parameters restore to default 1 (P.999=1)
			5	Some parameters restore to default 2 (P.999=2)
			6	Some parameters restore to default 3 (P.999=3)

Setting Parameter restoration

- ◆ 1: When 00-02(P.996~P.999) is set to 1, screen will flash *Er.LL*, the alarm record will be erased after writing, and 00-02(P.996~P.999) is reset to 0.
- ◆ 2: When 00-02(P.996~P.999) is set to 1, screen will flash *rEST* and inverter will be reset, then 00-02(P.996~P.999) is reset to 0. After resetting the inverter, the accumulated values in “electronic thermal relay” and “IGBT module thermal relay” will be set to zero.
- ◆ 3: When 00-02(P.996~P.999) is set to 3, screen will flash *ALLC*, all the parameters will be restored to the default values except the parameters in table 1 below. After parameters are restored, 00-02(P.996~P.999) is reset to 0.
- ◆ **Exception** The parameters in table 1 below will not be restored to the default values:

Group	No.	Name
00-00	P.90	Inverter model
00-01	P.188	Firmware version
00-24	P.189	50Hz/60Hz switch selection
00-25	P.990	Parameter mode setting
00-26	P.125	Expansion card type
00-27	P.991	Frequency mode setting
01-08	P.21	Acceleration/deceleration time increments
03-59	P.585	Monitor inverter digital input terminal state
03-60	P.586	Monitor inverter and expanded digital output terminal state
03-61	P.587	Monitor expanded digital input terminal state
06-27	P.292	Total inverter operation time (minutes)
06-28	P.293	Total inverter operation time (minutes)
06-29	P.296	Total inverter power on time (minutes)
06-30	P.297	Total inverter power on time (days)
06-31	P.298	Output power(low 16 position)

Group	No.	Name
06-32	P.299	Output power(high 16 position)
06-44	P.740	E1
06-45	P.741	E2
06-46	P.742	E3
06-47	P.743	E4
06-48	P.744	E5
06-49	P.745	E6
06-50	P.746	E7
06-52	P.748	E9
06-53	P.749	E10
06-54	P.750	E11
06-55	P.751	E12
06-56	P.752	E1 alarm output frequency
06-57	P.753	E1 alarm output current
06-58	P.754	E1 alarm output voltage
06-59	P.755	E1 alarm the temperature rising accumulation rate
06-60	P.756	E1 alarm PN voltage
06-61	P.757	E1 alarm the time of the inverter has run

## System parameter group 00

Group	No.	Name	Group	No.	Name
06-62	P.758	E1 alarm the inverter operation status code	06-75	P.771	E2 alarm the time of inverter has run
06-63	P.759	E1 alarm(years/months)	06-76	P.772	E2 alarm the inverter operation status code
06-65	P.761	E1 alarm (minutes/seconds)	06-77	P.773	E2 alarm (years/months)
06-70	P.766	E2 alarm output frequency	06-78	P.774	E2 alarm (days/hours)
06-71	P.767	E2 alarm output current	06-79	P.775	E2 alarm (minutes/seconds)
06-72	P.768	E2 alarm output voltage	07-44	P.829	EP301 communication expansion card version number
06-73	P.769	E2 alarm the temperature rising accumulation rate	09-13	P.124	Expansion card version
06-74	P.770	E2 alarm PN voltage	13-02	P.285	Low frequency vibration inhibition factor

◆ 4: : When 00-02(P.996~P.999) is set to 4, screen will flash *P.r.t.r*, all the parameters will be restored to the default values except the parameters in table 1 and table 2 below after writing. After parameters are restored, 00-02(P.996~P.999) is reset to 0.

◆ **Exception** The parameters in table 2 below and table 1 will not be restored to default values:

Group	No.	Name
00-21	P.300	Motor control mode selection
02-12	P.192	Terminal 2-5 minimum input positive voltage
02-13	P.193	Terminal 2-5 maximum input positive voltage
02-14	P.194	Percentage corresponds to terminal 2-5 minimum positive voltage
02-15	P.195	Percentage corresponds to terminal 2-5 maximum positive voltage
02-16	P.512	Terminal 2-5 minimum input negative voltage
02-17	P.513	Terminal 2-5 maximum input negative voltage
02-18	P.510	Percentage corresponds to terminal 2-5 minimum negative voltage
02-19	P.511	Percentage corresponds to terminal 2-5 maximum negative voltage
02-25	P.198	Terminal 4-5 minimum input current/ voltage
02-26	P.199	Terminal 4-5 maximum input current/ voltage
02-27	P.196	Percentage corresponds to terminal 4-5 minimum input current/ voltage
02-28	P.197	Percentage corresponds to terminal 4-5 maximum input current/ voltage
02-39	P.524	Terminal HDI minimum input frequency
02-40	P.525	Terminal HDI maximum input frequency
02-41	P.522	Percentage corresponds to terminal HDI minimum input frequency
02-42	P.523	Percentage corresponds to terminal HDI maximum input frequency
02-46	P.191	AM output gain

Group	No.	Name
02-47	P.190	AM output bias
02-59	P.187	FM calibration parameter
05-00	P.301	Motor parameter auto-tuning function selection
05-01	P.302	Motor rated power
05-02	P.303	Motor poles
05-03	P.304	Motor rated voltage
05-04	P.305	Motor rated frequency
05-05	P.306	Motor rated current
05-06	P.307	Motor rated rotation speed
05-07	P.308	Motor excitation current
05-08	P.309	IM motor stator resistance
05-09	P.310	IM motor rotor resistance
05-10	P.311	IM motor leakage inductance
05-11	P.312	IM motor mutual inductance
05-12	P.313	PM motor stator resistance
05-17	P.318	Rotation inertia
05-18	P.319	Load inertia ratio
11-00	P.320	Speed control proportion coefficient 1
11-01	P.321	Speed control integral time 1
11-01	P.321	Speed control integral time 1
11-02	P.322	PI coefficient switching frequency 1
11-03	P.323	Speed control proportion coefficient 2
11-04	P.324	Speed control integral time 2

- ◆ 5: User registered parameter 15-00(P.900)~15-19(P.919) and the parameters set in 15-00(P.900)~15-19(P.919) and the parameters in table 1 above will not be restored to default values. After parameters are restored, 00-02(P.996~P.999) is reset to 0.
- ◆ 6: User registered parameter 15-00~15-19 and the parameters set in 15-00(P.900)~15-19(P.919) and the parameters in table 1 above will not be restored to default values. After parameters are restored, 00-02(P.996~P.999) is reset to 0

Note: When the parameter is restored to default value or some of the parameters are restored to default value, be sure to wait for the screen to display **End**, which means that it's complete, and then perform other operations.

### 5.1.3 Parameter protection

- It is used to select whether parameters can be written to prevent changing parameter values due to misoperation.

Parameter	Name	Default	Setting Range	Content
00-03 P.77	Selection of parameters write protection	0	0	Parameters can be written only when the motor stops.
			1	Parameters cannot be written.
			2	Parameters can also be written when the motor is running.
			3	Parameters cannot be read when in password protection.
00-04 P.294	Password parameter	0	0~65535	Write the registered password to decrypt parameter protection.
00-05 P.295	Password setup	0	0~65535	Register password for parameter protection setting.

Setting Selection of parameters write protection

- ◆ Write parameters only during stop (00-03(P.77) = "0" initial value)

**Exception** When running, the parameters below can still be written:

Group	No.	Name	Group	No.	Name
00-03	P.77	Selection of parameters write protection	02-25	P.198	The minimum input current/voltage of 4-5
00-07	P.161	Multi-function display	02-26	P.199	The maximum input current/voltage of 4-5
02-04	P.54	Function of terminal AM output	02-27	P.196	The percentage corresponding to the minimum input current/voltage of 4-5
02-12	P.192	The minimum input positive voltage of 2-5	02-28	P.197	The percentage corresponding to the maximum input current/voltage of 4-5
02-13	P.193	The maximum input positive voltage of 2-5	02-39	P.524	HDI input minimum frequency
02-14	P.194	The percentage corresponding to the minimum positive voltage of terminal 2-5	02-40	P.525	HDI input maximum frequency
02-15	P.195	The percentage corresponding to the maximum positive voltage of terminal 2-5	02-41	P.522	The percentage corresponding to HDI input minimum frequency
02-16	P.512	The minimum input negative voltage of 2-5	02-42	P.523	The percentage corresponding to HDI input maximum frequency
02-17	P.513	The maximum input negative voltage of 2-5			
02-18	P.510	The percentage corresponding to the minimum negative voltage of terminal 2-5			
02-19	P.511	The percentage corresponding to the maximum negative voltage of terminal 2-5			

System parameter group 00

Group	No.	Name	Group	No.	Name
02-44	P.543	FM output function selection	04-21	P.133	Programmed operation mode speed 3
02-45	P.64	AM output signal selection	04-22	P.134	Programmed operation mode speed 4
02-46	P.191	AM output gain	04-23	P.135	Programmed operation mode speed 5
02-47	P.190	AM output bias	04-24	P.136	Programmed operation mode speed 6
02-51	P.55	Frequency display reference when in the analog output	04-25	P.137	Programmed operation mode speed 7
02-52	P.56	Current monitoring reference when in the analog output	04-26	P.138	Programmed operation mode speed 8
02-55	P.592	PT100 voltage level 1	06-17	P.261	Maintenance alarm function
02-56	P.593	PT100 voltage level 2	06-40	P.288	Alarm code query
02-59	P.187	FM calibration parameter	06-42	P.290	Alarm message query
03-14	P.87	Multifunctional digital input terminal positive/negative logic	08-03	P.225	PID target value panel reference
04-00	P.4	Speed1(high speed)	10-19	P.230	Dwell frequency at acceleration
04-01	P.5	Speed2(mediumspeed)	10-21	P.232	Dwell frequency at deceleration
04-02	P.6	Speed3(low speed)	10-45	P.267	Regeneration and avoidance operation selection
04-03	P.24	Speed4	10-46	P.268	Regeneration and avoidance DC bus voltage level
04-04	P.25	Speed5	10-47	P.269	DC bus voltage detection sensitivity at deceleration
04-05	P.26	Speed6	10-48	P.270	Regeneration and avoidance frequency compensation value
04-06	P.27	Speed7	10-49	P.271	Regeneration avoidance voltage gain coefficient
04-07	P.142	Speed8	10-50	P.272	Regeneration avoidance frequency gain coefficient
04-08	P.143	Speed9	10-55	P.780	PLC action selection
04-09	P.144	Speed10	10-56	P.781	PLC operation
04-10	P.145	Speed11	10-58	P.783	PLC component monitoring selection
04-11	P.146	Speed12	11-12	P.401	Torque reference
04-12	P.147	Speed13	14-05	P.605	Tension setting
04-13	P.148	Speed14	14-45	P.657	Line speed setting
04-14	P.149	Speed15			
04-19	P.131	Programmed operation mode speed 1			
04-20	P.132	Programmed operation mode speed 2			

◆ Most parameters cannot be written. (00-03(P.77) = "1")

◆ **Exception** Parameters below can be written.

Group	No.	Name
00-03	P.77	Selection of parameters write protection

Group	No.	Name
00-16	P.79	Operation mode selection

◆ When running, the parameters below can be written. (00-03(P.77) = "2")

**Exception** When running, the parameters below cannot be written:

Group	No.	Name	Group	No.	Name
00-00	P.90	The inverter model	06-50	P.746	E7
00-01	P.188	Firmware version	06-51	P.747	E8
00-11	P.72	Carrier frequency	06-52	P.748	E9
00-15	P.78	Forward/reverse rotation prevention selection	06-53	P.749	E10
00-16	P.79	Operation mode selection	06-54	P.750	E11
00-26	P.125	Expansion card type	06-55	P.751	E12
03-59	P.585	Monitor inverter digital input terminal state	06-56	P.752	E1 alarm output frequency
03-60	P.586	Monitor inverter and expanded digital output terminal state	06-57	P.753	E1 alarm output current
03-61	P.587	Monitor expanded digital input terminal state	06-58	P.754	E1 alarm output voltage
06-01	P.22	Stall prevention operation level	06-59	P.755	E1 alarm the temperature rising accumulation rate
06-08	P.155	Over torque detection level	06-60	P.756	E1 alarm PN voltage
06-11	P.160	Stall level when restart	06-61	P.757	E1 alarm the time of inverter has run
06-21	P.705	Low voltage level	06-62	P.758	E1 alarm inverter operation status code
06-22	P.706	Regenerative brake operation level	06-63	P.759	E1 alarm(years/months)
06-23	P.707	Regenerative brake operation level	06-64	P.760	E1 alarm (days/hours)
06-25	P.709	Electrolytic capacitor life detection level	06-65	P.761	E1 alarm (minutes/seconds)
06-26	P.710	Capacitor lifetime detection level	06-70	P.766	E2 alarm output frequency
06-27	P.292	Accumulative motor operation time(minutes)	06-71	P.767	E2 alarm output current
06-28	P.293	Accumulative motor operation time (days)	06-72	P.768	E2 alarm output voltage
06-29	P.296	Accumulative motor power time (minutes)	06-73	P.769	E2 alarm the temperature rising accumulation rate
06-30	P.297	Accumulative motor power time (days)	06-74	P.770	E2 alarm PN voltage
06-31	P.298	Output power(low 16 position)	06-75	P.771	E2 alarm the time of inverter has run
06-32	P.299	Output power(high 16 position)	06-76	P.772	E2 alarm inverter operation status code
06-41	P.289	Alarm code display	06-77	P.773	E2 alarm (years/months)
06-43	P.291	Alarm message display	06-78	P.774	E2 alarm (days/hours)
06-44	P.740	E1	06-79	P.775	E2 alarm (minutes/seconds)
06-45	P.741	E2	07-17	P.802	CANopen communication status
06-46	P.742	E3	07-18	P.803	CANopen control status
06-47	P.743	E4	09-13	P.124	Expansion card version
06-48	P.744	E5	10-52	P.265	Over excitation current level
06-49	P.745	E6	11-13	P.402	Speed limit
			11-14	P.403	Speed limit bias
			14-20	P.618	Current value of curling radius
			14-32	P.630	Actual line speed

◆ When in password protection, parameters cannot be read. (00-03(P.77) = "3")

**Exception** Parameters below can still be read:

Group	No.	Name
00-00	P.90	The inverter model
00-01	P.188	Firmware version
00-05	P.295	Password setup
00-08	P.37	Speed display

Group	No.	Name
00-16	P.79	Operation mode selection
00-25	P.990	Parameter mode setting
00-26	P.125	Expansion card type
00-27	P.991	Frequency mode setting

## System parameter group 00

Group	No.	Name	Group	No.	Name
01-00	P.1	Maximum frequency	06-58	P.754	E1 alarm output voltage
01-01	P.2	Minimum frequency	06-59	P.755	E1 alarm the temperature rising accumulation rate
03-59	P.585	Monitor inverter digital input terminal state	06-60	P.756	E1 alarm PN voltage
03-60	P.586	Monitor inverter and expanded digital output terminal state	06-61	P.757	E1 alarm the time of inverter has run
03-61	P.587	Monitor expanded digital input terminal state	06-62	P.758	E1 alarm inverter operation status code
06-26	P.710	Capacitor lifetime detection level	06-63	P.759	E1 alarm(years/months)
06-41	P.289	Alarm code display	06-64	P.760	E1 alarm (days/hours)
06-43	P.291	Alarm message display	06-65	P.761	E1 alarm (minutes/seconds)
06-44	P.740	E1	06-70	P.766	E2 alarm output frequency
06-45	P.741	E2	06-71	P.767	E2 alarm output current
06-46	P.742	E3	06-72	P.768	E2 alarm output voltage
06-47	P.743	E4	06-73	P.769	E2 alarm the temperature rising accumulation rate
06-48	P.744	E5	06-74	P.770	E2 alarm PN voltage
06-49	P.745	E6	06-75	P.771	E2 alarm the time of inverter has run
06-50	P.746	E7	06-76	P.772	E2 alarm inverter operation status code
06-51	P.747	E8	06-77	P.773	E2 alarm (years/months)
06-52	P.748	E9	06-78	P.774	E2 alarm (days/hours)
06-53	P.749	E10	06-79	P.775	E2 alarm (minutes/seconds)
06-54	P.750	E11	07-17	P.802	CANopen communication status
06-55	P.751	E12	07-18	P.803	CANopen control status
06-56	P.752	E1 alarm output frequency	09-13	P.124	Expansion card version
06-57	P.753	E1 alarm output current	14-20	P.618	Current value of curling radius
			14-32	P.630	Actual line speed

### Setting Password protection

- ◆ Register a password
  1. Write a number (2 ~ 65535) in 00-05(P.295) as a password, password protection takes effect immediately;
  2. After registering a password, 00-05(P.295)=1;
- ◆ Unlock password protection
  1. Write the correct password in 00-04(P.294), and then password protection will be unlocked;
  2. After unlocking the password, 00-04(P.294)=0, 00-05(P.295)=1;
  3. If turn the power off and then turn on, inverter will still restore to the password protection status.
- ◆ Password all clear
  1. Write the correct password in 00-04(P.294) to unlock the password protection;
  2. Write 0 in 00-05(P.295), password will be all cleared.

Note: If password is forgotten, enter the same incorrect password three times in **00-04(P.294)**, and the interval between two consecutive times is not more than 10s. The password can be cleared and the user parameters will be automatically restored to default.

## 5.1.4 Monitoring function

➤ The item to be displayed on the parameter unit can be selected.

Parameter	Name	Default	Setting Range	Content
00-06 P.110	Keypad monitoring selection	1	X0	X0: When inverter starts, keypad enters monitor mode automatically, screen displays output frequency. (Note 1)
			X1	When inverter starts, screen displays steady state frequency.
			X2	When inverter starts, keypad enters monitor mode automatically, screen displays current pressure and feedback pressure of the constant pressure system in percentage
			X5	When inverter starts, keypad enters monitor mode automatically, screen displays current pressure and feedback pressure of the constant pressure system
			0X	Boot screen monitors output frequency
			1X	Boot screen is in target frequency setting mode
			2X	Boot screen monitors output current
			3X	Boot screen monitors output voltage
00-07 P.161	Multi-function display	0	0	Output AC voltage (V)
			1	Voltage between (+/P) and (-/N) terminals. (V)
			2	Inverter temperature rising accumulation rate (%)
			3	Target pressure of the constant pressure system (%)
			4	Feedback pressure of the constant pressure system (%)
			5	Running frequency (Hz)
			6	Electronic thermal accumulation rate (%)
			7	Signal value (V) of 2-5 input terminals.
			8	Signal value (mA) of 4-5 input terminals (mA/V).
			9	Output power (kW).
			10	PG card feedback rotation speed. (Hz)
			11	Forward reverse rotation signal. 1: forward rotation 2: reverse rotation 0: stop.
			12	NTC temperature (°C)
			13	Motor electronic thermal accumulation rate (%)
			15	Input frequency of terminal HDI. (kHz)
			16	Real-time roll diameter. (mm)
			17	Real-time line speed. (m/min)
			18	Output torque of inverter (%) (Valid only when 00-21 (P. 300) or 00-22 (P. 370) is set to 3 ~ 6 )
			19	Digital terminal input state
			20	Digital terminal output state
			21	Actual working carrier frequency
			23	Synchronous motor rotor pole position ( Show motor rotor magnetic pole position from encoder feedback, valid when 00-21 (P. 300) = 5)
			24	Current target frequency
			25	PTC input percentage
			26	Target pressure and feedback pressure from constant pressure system
			27	Motor rotation speed
28	Power factor			
29	Power accumulation rate (kWh)			
30	PG feedback rotation speed			
31	Motor rotor position (Z pulse as 0)			
32	PG card A1 B1 feedback pulse number			
33	PG card A2 B2 given pulse number			

Note: 1. The "output frequency" here is the value after slip compensation.

- In output frequency setting mode, the screen will be cut to output frequency setting mode when the "FWD" or "REV" or "STOP" button is pressed.
- The target frequency setting mode screen displays the target pressure. If target frequency command comes from keypad, the target pressure can be set directly in the target frequency setting mode.
- The multi-function display function is implemented in the monitor voltage mode. For switching to monitor voltage mode, refer to section 4.2.3.
- Please refer to section 5.4.15 for terminal sequence. The status of the digital input terminal corresponds to 03-59 (P.585), and the status of the digital output terminal corresponds to 03-60 (P.586).

**Display** Keypad monitoring selection

- ◆ Display the target pressure percentage and feedback pressure percentage of the current constant pressure system (00-06(P.110) = "X2").

The screen shows two sections. A decimal point is used to separate the boundaries, on the left is the target pressure of the constant pressure system and on the right is the feedback pressure of the constant pressure system. As shown in this figure , 20 means the target pressure of the constant pressure system is 2.0kg/cm<sup>3</sup>; 30 means the feedback pressure of the constant pressure system is 3.0kg/cm<sup>3</sup>.

**Display** Multi-function display

The display value will show in the monitor voltage mode. Please refer to 4.2.3 for flow chart of monitoring mode.

### 5.1.5 Speed display

- In “monitoring output frequency” mode, the screen displays corresponding machine speed.

Parameter	Name	Default	Setting Range	Content
00-08 P.37	Speed display	0.0	0	0: Display output frequency(not mechanical speed)
			0.1~5000.0	When 00-09(P.259)=1
			1~50000	When 00-09(P.259)=0
00-09 P.259	Speed unit selection	1	X0	Speed display unit is 1
			X1	Speed display unit is 0.1
			0X	Power accumulation rate unit is 1
			1X	Power accumulation rate unit is 0.1
			2X	Power accumulation rate unit is 0.01

**Setting** Speed display

- ◆ The setting value of 00-08(P.37) is the speed of motor when output frequency is 60Hz.

For example:

1. If the transmitting belt speed is 950 m/minute when the inverter output frequency is 60Hz, set 00-08(P.37) = 950.
2. After setting, in the keypad “output frequency monitor mode” , the screen will display the speed of the transmitting belt.

NNote: 1.The machine speed on the screen is the theoretical value calculated proportionately by the inverter output frequency and the setting value of 00-08(P.37). So there's minute discrepancy between the displayed machine speed and the actual one.  
2. The value in 00-09 (P. 259) = 0X, 1X, 2X is only readable in communication mode.

### 5.1.6 PWM carrier frequency

- The motor sound can be changed by adjusting PWM carrier frequency properly.

Parameter	Name	Default	Setting Range	Content
00-11 P.72	Carrier frequency	5kHz	1~15 kHz	---
00-12 P.31	Soft-PWM carrier operation selection	0	0	Off
			1	When 00-11(P.72)< 5, Soft-PWM is valid(only apply to V/F control )



### Setting Carrier frequency

- ◆ The higher the carrier frequency, the lower the motor acoustic noise, but will result in greater leakage current and larger noise generated by the inverter.
- ◆ The higher the carrier frequency, the more energy inverter will consume, and temperature will also be higher.
- ◆ If mechanical resonance occurred in a system, **00-11(P.72)** can also be adjusted to lower the vibration.



Note: The setting value of carrier frequency is best to be 8 times larger than the target frequency.

### Setting Carrier operation selection V/F

- ◆ Soft-PWM control is a control method that changes the motor noise from a metallic sound into an inoffensive, complex tone.
- ◆ Motor noise modulation control is when the inverter changes its carrier frequency from time to time during operation, metal noises generated by the motor will not be in a single frequency, so sharp single frequency noises will be reduced.
- ◆ This function is only usable under V/F control mode; i.e., it is usable when **00-21(P.300)=0**.

## 5.1.7 Stop operation selection

➤ Select the inverter stop method

Parameter	Name	Default	Setting Range	Content
00-13 P.71	Idling brake / DC brake	1	0	Idling brake
			1	DC brake
00-14 P.75	 function selection	1	0	Press  button and inverter stop running in PU and H2(combine mode 2) mode
			1	Press  button and inverter stop running in all mode.

### Setting Idling brake / DC brake

- ◆ Idling brake **(00-13(P.71)="0")**

After receiving stop signal, inverter stops output immediately, and the motor idle freely.

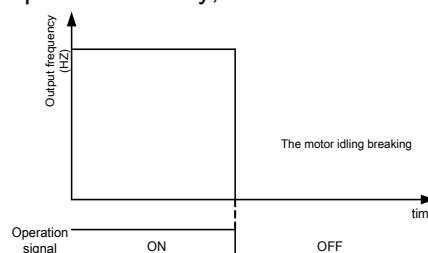

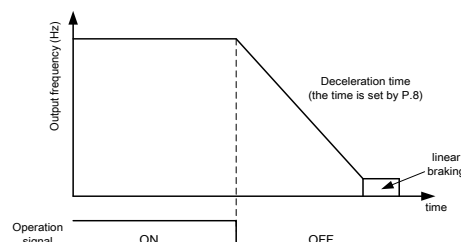

- ◆ DC braking **(00-13(P.71)="1")**

After receiving stop signal, inverter decelerates according to the acceleration/deceleration curve until it stops completely.



## System parameter group 00

Setting  button function selection

◆ Press  button to stop during operation (00-14(P.75)="1")

**Note:** When running in non-PU and H2 modes, pressing the  button will display E0 and lock all functions on the keypad. Please follow the steps below to cancel this state:

1. If the start signal is given from digital input terminal, switch off the signal (Note1);
2. Press  button for over 1.0 second to remove E0 state.

◆ No matter which mode inverter is in, press  button for over 1.0 second will reset the inverter after alarm occurs.

Note: 1. In programmed operation mode, it is not necessary to switch off the start signal. Inverter will run at the section where it stopped after reset.)

2. After resetting, the values of "electronic thermal relay" and "IGBT module thermal relay" will be set to zero.

### 5.1.8 Forward/reverse rotate prevent function

➤ Set this parameter to limit the motor rotation to only one direction, and prevent reverse rotation fault resulting from the incorrect input of the start signal.

Parameter	Name	Default	Setting Range	Content
00-15 P.78	Prevent forward/ reverse rotation selection	0	0	Forward/reverse rotation are both permitted.
			1	Prevent reverse rotation (Giving reverse signal decelerates and stops the motor).
			2	Prevent forward rotation (Giving forward signal decelerates and stops the motor).

Note: It is valid to all start signals.

### 5.1.9 Operation mode selection

➤ Select the operation mode of the inverter, and determine the source of start signal and target frequency.

Parameter	Name	Default	Setting Range	Content
00-16 P.79	Operation mode selection	0	0	"PU mode", "external mode" and "Jog mode" are interchangeable.
			1	"PU mode" and "JOG mode" are interchangeable.
			2	"External mode" only
			3	"Communication mode" only
			4	"Combined mode 1"
			5	"Combined mode 2"
			6	"Combined mode 3"
			7	"Combined mode 4"
			8	"Combined mode 5"
			99999	The second operation mode, operating instruction is set by 00-18(P.109), the target frequency is set by 00-17(P.97)

Parameter	Name	Default	Setting Range	Content
00-17 P.97	Second target frequency selection	0	0	Frequency set by keypad
			1	Frequency set by RS485 communication
			2	Frequency set by analog input
			3	Frequency set by communication expansion card
			4	Frequency set by PG card A2 B2
			5	Frequency set by HDI pulse
00-18 P.109	Second start signal selection	0	0	Start signal set by keypad
			1	Start signal set by digital input terminal
			2	Start signal set by RS485 communication
			3	Start signal set by communication expansion card
00-19 P.35	Communication mode selection	0	0	In communication mode, run signal and frequency is given by communication.
			1	In communication mode, run signal and frequency is given by external signal.

Setting Operation mode selection

- ◆ Please refer to Section 4.3 for detailed setting and usage.

Setting Communication mode instruction selection

- ◆ When 00-16(P.79)=3, select communication mode:
  1. If 00-19(P.35)=0, Start and frequency command is given by communication;
  2. If 00-19(P.35)=1, Start and frequency command is given by external terminals.

### 5.1.10 Control mode selection

- Select the control mode by setting 00-20(P.400).

Parameter	Name	Default	Setting Range	Content
00-20 P.400	Control mode selection	0	0	Speed control
			1	Torque control
			2	Position control

Setting Control mode selection

- ◆ If 00-20(P.400) = 0, torque control is off, and inverter runs speed control in closed-loop vector; 00-20(P.400) = 1, torque control is on, and inverter runs torque control. In torque control, inverter needs to work in closed loop vector control mode, so a speed measuring encoder must be installed.
- ◆ The combination of using 00-20(P.400) control mode selection with digital input function: control mode switch (03-00~03-05(P.80~P.84,P.86)=55/63) is shown as the following sheet.

00-20	Digital input function		Digital input function
	speed/torque switch	speed/torque switch	
0	Terminal function not set	Terminal function not set	Speed control
1	Terminal function not set	Terminal function not set	Torque control
2	Terminal function not set	Terminal function not set	Position control
0	Terminal function set and signal given	---	Torque control
0	Terminal function set and signal not given	---	Speed control
2	---	Terminal function set and signal given	Position control
2	---	Terminal function set and signal not given	Speed control

## 5.1.11 Motor control mode selection

➤ Choose control mode for the AC motor

Parameter	Name	Default	Setting Range	Content
00-21 P.300	Motor control mode selection	0	0	Induction motor V/F control
			1	Induction motor closed-loop V/F control (VF + PG)
			2	Induction motor simple vector control
			3	Induction motor sensorless vector control
			4	Induction motor PG vector control
			5	Synchronous motor PG vector control
			6	Synchronous motor vector control without PG
00-22 P.370	Second motor control mode selection	99999	0	Induction motor V/F control
			1	Induction motor close-loop V/F control (VF+PG)
			2	Induction motor simple vector control
			3	Induction motor sensorless vector control
			4	Induction motor PG vector control
			5	Synchronous motor PG vector control
			6	Synchronous motor vector control without PG
			99999	Off

Setting Motor control mode

- ◆ Induction motor V/F control: user can design proportion of V/F as required and can control multiple motors simultaneously.
- ◆ Induction motor close-loop V/F control (VF + PG): user can use optional PG card with encoder for closed-loop speed control.
- ◆ Induction motor simple vector control: Output voltage is increased to compensate the frequency change when motor load is increased.
- ◆ Induction motor sensorless vector control: Auto-tuning the motor to reach optimal control performance.
- ◆ Induction motor PG vector control: Increases output torque and accuracy of speed control.
- ◆ Synchronous motor PG vector control: Increases output torque and accuracy of speed control.
- ◆ Synchronous motor without PG vector control: get the optimal control by the auto-tuning of motor parameters.

Note: 1. The motor capacity must be the same level or one level lower than the inverter capacity.

2. Sensorless vector control: Control performance can be enhanced by auto-tuning. Before setting 00-21 (P.300) = 3 or 4, please set the motor parameters first, then do auto-tuning to increase the precision of the control.
3. When selecting V/F + PG (set 00-21 (P.300) = 1) control mode, please be sure to set the right motor pole number (05-02(P.303)).
4. When 10-03 (P.151) = 1, the motor performs zero-speed operation under closed-loop vector control; motor performs DC voltage braking under V/F closed-loop control.
5. When 00-22 (P.370) ≠ 99999 and RT signal is given, the second motor parameters 05-22(P.332)~05-38(P.394) are valid, please refer to section 5.2.10 for second function parameter.
6. RT mentioned here is the function name of "multi-function digital input terminal". Please refer to 03-00~03-05(P.80~P.84、P.86), P.86, for the function selection of multi-function digital input terminal; please refer to **section 3.7 terminal wire arrangement**.

### 5.1.12 Motor types selection

- Modify the applicable load type of the inverter.

Parameter	Name	Default	Setting Range	Content
00-23 P.186	Motor types selection	1	0	Normal Duty (ND), on fan and pump duty type.
			1	Heavy Duty (HD), apply to other duties.

Settin Motor types selection

- ◆ In order to switch to heavy duty setting (00-23(P.186)= 0), be sure to perform the following steps. After these steps are completed, the duty type will be successfully switched.

1. Set 00-23(P.186)=0;
2. Set 00-02=3(P.998=1) to set all parameters to default;
3. Set 00-02=2(P.997=1) to reset inverter.

### 5.1.13 50/60Hz switch selection

- Select between 50Hz or 60Hz according to different power source frequency or default motor frequency, this effects all frequency-related parameters.

Parameter	Name	Default	Setting Range	Content
00-24 P.189	50/60 Hz switch selection	0	0	Frequency related parameter default value is 60Hz.
		1	1	Frequency related parameter default value is 50Hz.

Settin 50/60Hz switch selection

- ◆ The following two steps shows how to set frequency related parameter to 60Hz system (00-24(P.189)="0").
1. Set 00-24(P.189)=0;
  2. Set 00-02=3(P.998=1) to set all parameters to default, at this point frequency-related parameters of the inverter will be reset to 60Hz.

- ◆ The following parameters are affected:

Group	No.	Name
01-03	P.3	Base frequency
01-09	P.20	Accelerate/decelerate reference frequency
02-09	P.38	2-5 maximum operation frequency
02-21	P.39	The maximum operation frequency of terminal 4-5
02-30	P.508	Reserve

Group	No.	Name
02-51	P.55	Frequency display reference when in the analog output
05-03	P.304	Motor rated voltage
05-04	P.305	Motor rated frequency
05-06	P.307	Motor rated rotation speed
06-03	P.66	Stall prevention operation reduction starting frequency
10-41	P.701	VF separated voltage digital

### 5.1.14 Parameter mode setting

➤ Select "Parameter P mode" or "group mode" to display parameters.

Parameter	Name	Default	Setting Range	Content
00-25	Parameter display mode setting	0	0	Parameter is displayed in "group mode"
P.990			1	Parameter is displayed in "parameter P mode"

Display Parameter mode setting

◆ "Group mode" displaying

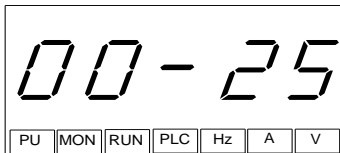

◆ "Parameter P mode" displaying

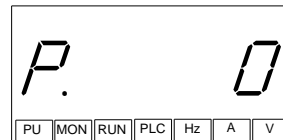

### 5.1.15 Frequency mode setting

Parameter	Name	Default	Setting Range	Content
00-27	Frequency mode setting	0	0-1	Normal mode
P.991				High speed mode

Setting Frequency mode setting

- ◆ After setting frequency mode setting 00-27 (P. 991), please be sure to operate 00-02 = 3(p. 998 = 1) and 00-02 = 2(p. 997=1) to fit the frequency-dependent parameters;
- ◆ Normal mode frequency related parameters range 0 ~ 650.00 Hz, minimum set unit 0.01 Hz;
- ◆ High speed related parameters range 0 ~ 1500.0 Hz, minimum set unit 0.1 Hz;
- ◆ Frequency related parameters refers to parameters with "Hz" as unit, For example, 01-00~01-03(P.1~P.3)、04-00~04-02(P.4~P.6)

### 5.1.16 Expansion card type display

➤ This parameter is used to check the expansion card type, and cannot be modified.

Parameter	Name	Default	Setting Range	Content
00-26	Expansion card type	Read	Read only	It is used to display the current expansion card type, for read only.
P.125				

Read Current expansion card type

- ◆ All bits are 1 when no card insert.
- ◆ The definition of each 00-26 (P.125) bit is as follows:

bit	2 <sup>3</sup>	2 <sup>2</sup>	2 <sup>1</sup>	2 <sup>0</sup>
	bit	bit	bit	bit
	3	2	1	0

◆ The values for all kinds of expansion cards are as the following table :

Expansion card type	Model	Bit value			
Communication Expansion card	PD301	0	1	0	1
	DN301	1	0	0	1
	CP301	1	1	0	1
	EP301	0	0	1	1
	EC301	1	1	0	0
I/O Expansion card	EB362R	1	0	1	0
	EB308R	0	1	1	0
PG Expansion card	PG301C	0	0	0	0
	PG301L	0	0	0	1
	PG302L	0	0	1	0

For example: Insert EP301, the read-out value of 00-26(P.125) is as follows:

$$0 \times 2^3 + 0 \times 2^2 + 1 \times 2^1 + 1 \times 2^0 = 3$$

Note: Inverter will display alarm if the expansion card is loose. Please refer to 7.2 Appendix 2: Alarm code list.

## 5.2 Basic parameter group 01

Group	Parameter Number	Name	Setting Range	Default	Page
01-00	P.1	Maximum frequency	0.00~01-02(P.18)Hz	120.00Hz	<u>80</u>
01-01	P.2	Minimum frequency	0 ~ 120.00Hz	0.00Hz	<u>80</u>
01-02	P.18	High-speed maximum frequency	01-00(P.1) ~ 650.00Hz	120.00Hz	<u>80</u>
01-03	P.3	Base frequency	50Hz system setting: 0 ~ 650.00Hz	50.00Hz	<u>80</u>
			60Hz system setting: 0 ~ 650.00Hz	60.00Hz	
01-04	P.19	Base voltage	0 ~ 1000.0V	99999	<u>80</u>
			99999: Change according to the input voltage		
01-05	P.29	Acceleration/deceleration curve selection	0: Linear acceleration /deceleration curve	0	<u>81</u>
			1: S shape acceleration /deceleration curve 1		
			2: S shape acceleration /deceleration curve 2		
			3: S shape acceleration /deceleration curve 3		
01-06	P.7	Acceleration time	3.7K and below: 0 ~ 360.00s/0 ~ 3600.0s	5.00s	<u>81</u>
			5.5K and above: 0~360.00s/0 ~ 3600.0s	20.00s	
01-07	P.8	Deceleration time	3.7K and below: 0 ~ 360.00s/0 ~ 3600.0s	5.00s	<u>81</u>
			5.5K~7.5K :0 ~ 360.00s/0 ~ 3600.0s	10.00s	
			11K and above:0 ~ 360.00s/0 ~ 3600.0s	30.00s	
01-08	P.21	Acceleration/deceleration time increments	0: Time increment is 0.01s	0	<u>81</u>
			1: Time increment is 0.1s		
01-09	P.20	Acceleration/deceleration reference frequency	50Hz system setting: 1.00 ~ 650.00Hz	50.00Hz	<u>81</u>
			60Hz system setting: 1.00 ~ 650.00Hz	60.00Hz	
01-10	P.0	Torque boost	0.75K and below: 0 ~ 30.0%	6.0%	<u>83</u>
			1.5K ~ 3.7K: 0 ~ 30.0%	4.0%	
			5.5K ~ 7.5K: 0 ~ 30.0%	3.0%	
			11K ~ 22K: 0 ~ 30.0%	2.0%	
01-11	P.13	Starting frequency	0 ~ 60.00Hz	0.50Hz	<u>84</u>
01-12	P.14	Load pattern selection	0: For constant torque loads (conveyor belt,etc.)	0	<u>84</u>
			1: For variable torque loads (fans and pumps, etc.)		
			2~3: For Lifting loads		
			4: Multipoint V/F curve		
			5~13: Special two-point V/F curve		
			14: V/F complete detached mode		
15: V/F semidetached mode					
01-13	P.15	JOG frequency	0 ~ 650.00Hz	5.00Hz	<u>87</u>
01-14	PP.	JOG acceleration/ deceleration time	0 ~ 360.00s/0 ~ 3600.0s	0.50s	<u>87</u>
01-15	P.28	Output frequency filter time	0 ~ 1000ms	0ms	<u>87</u>
01-16	P.91	Frequency jump 1A	0 ~ 650.00Hz	99999	<u>88</u>
			99999: Off		



Group	Parameter Number	Name	Setting Range	Default	Page
01-17	P.92	Frequency jump 1B	0 ~ 650.00Hz 99999: Off	99999	<u>88</u>
01-18	P.93	Frequency jump 2A	0 ~ 650.00Hz 99999: Off	99999	<u>88</u>
01-19	P.94	Frequency jump 2B	0 ~ 650.00Hz 99999: Off	99999	<u>88</u>
01-20	P.95	Frequency jump 3A	0 ~ 650.00Hz 99999: Off	99999	<u>88</u>
01-21	P.96	Frequency jump 3B	0 ~ 650.00Hz 99999: Off	99999	<u>88</u>
01-22	P.44	Second acceleration time	0 ~ 360.00s/0 ~ 3600.0s 99999: Off	99999	<u>89</u>
01-23	P.45	Second deceleration time	0 ~ 360.00s/0 ~ 3600.0s 99999: Off	99999	<u>89</u>
01-24	P.46	Second torque boost	0 ~ 30.0% 99999: Off	99999	<u>89</u>
01-25	P.47	Second base frequency	0 ~ 650.00Hz 99999: Off	99999	<u>89</u>
01-26	P.98	Middle frequency 1	0 ~ 650.00Hz	3.00Hz	<u>90</u>
01-27	P.99	Output voltage 1 of middle frequency	0 ~ 100.0%	10.0%	<u>90</u>
01-28	P.162	Middle frequency 2	0 ~ 650.00Hz 99999: Off	99999	<u>90</u>
01-29	P.163	Output voltage 2 of middle frequency	0 ~ 100.0%	0.0%	<u>90</u>
01-30	P.164	Middle frequency 3	0 ~ 650.00Hz 99999: Off	99999	<u>90</u>
01-31	P.165	Output voltage 3 of middle frequency	0 ~ 100.0%	0.0%	<u>90</u>
01-32	P.166	Middle frequency 4	0 ~ 650.00Hz 99999: Off	99999	<u>90</u>
01-33	P.167	Output voltage 4 of middle frequency	0 ~ 100.0%	0.0%	<u>90</u>
01-34	P.168	Middle frequency 5	0 ~ 650.00Hz 99999: Off	99999	<u>90</u>
01-35	P.169	Output voltage 5 of middle frequency	0 ~ 100.0%	0.0%	<u>90</u>
01-36	P.255	S curve time at the beginning of acceleration	0 ~ 25.00s/0 ~ 250.0s	0.20s	<u>90</u>
01-37	P.256	S curve time at the end of acceleration	0 ~ 25.00s/0 ~ 250.0s 99999: Off	99999	<u>90</u>
01-38	P.257	S curve time at the beginning of deceleration	0 ~ 25.00s/0 ~ 250.0s 99999: Off	99999	<u>90</u>
01-39	P.258	S curve time at the end of deceleration	0 ~ 25.00s/0 ~ 250.0s 99999: Off	99999	<u>90</u>
01-40	P.219	Remote frequency acceleration/deceleration time selection	0: use current acceleration/deceleration time 1: use second acceleration/deceleration time	0	<u>92</u>
01-43	P.215	Second base voltage	0 ~ 1000.0V 99999: fluctuate with input voltage	99999	<u>89</u>

### 5.2.1 Limiting the output frequency

➤ Output frequency can be limited. Fix the output frequency at the upper and lower limits.

Parameter	Name	Default	Setting Range	Content
01-00 P.1	Maximum frequency	120.00Hz	0.00 ~ 01-02(P.18)Hz	Set maximum output frequency
01-01 P.2	Minimum frequency	0.00Hz	0 ~ 120.00Hz	Set minimum output frequency
01-02 P.18	High-speed maximum frequency	120.00Hz	01-00(P.1) ~ 650.00Hz	Set when need inverter to run over 120Hz

**Setting** Maximum frequency, high-speed maximum frequency

- ◆ The “maximum frequency” and the “high-speed maximum frequency” are interrelated:
  1. If the target frequency upper limit is set below 01-00(P.1), use 01-00(P.1) as the maximum frequency;
  2. If the target frequency upper limit is set above 01-00(P.1), use 01-02(P.18) as the maximum frequency.
- ◆ If 01-00(P.1) < 01-01(P.2), the steady output frequency will be fix at 01-00(P.1) value.
- ◆ When setting the target frequency in PU mode, the frequency set value cannot exceed the value of 01-00(P.1).

**Setting** Minimum frequency

- ◆ If the target frequency ≤ 01-01(P.2), the steady output frequency = 01-01(P.2).
- ◆ If 01-01(P.2) < target frequency ≤ 01-00(P.1)/00-02(P.18), the steady output frequency = target frequency.

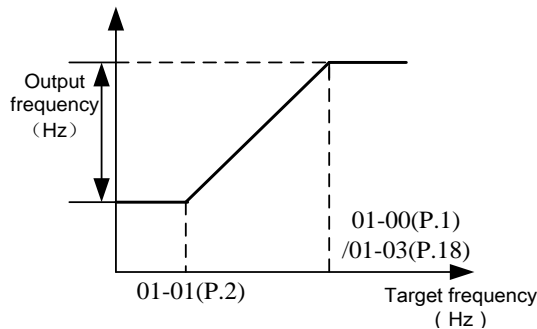

### 5.2.2 Base frequency, base voltage

➤ Use this function to adjust the inverter outputs (voltage, frequency) to match with the motor rating.

Parameter	Name	Default	Setting Range	Content
01-03 P.3	Base frequency	50.00Hz	0.00 ~ 650.00Hz	50Hz system (00-24(P.189)=1)
		60.00Hz		60Hz system (00-24(P.189)=0)
01-04 P.19	Base voltage	99999	0 ~ 1000.0V	Set base voltage according to motor rating.
			99999	Base voltage is equal to power source voltage.

Settin	Base frequency
--------	----------------

- ◆ Generally, 01-03(P.3) is set as the rated frequency of motor.  
When the rated frequency on the motor nameplate is "50 Hz", make sure to set **base frequency** to "50 Hz". If set it to "60 Hz" the voltage will drop too much, causing torque to drop. As a result, the inverter may trip due to overload
- ◆ When running the motor requires switching to the commercial power supply, set the commercial power supply voltage value in 01-03(P.3).

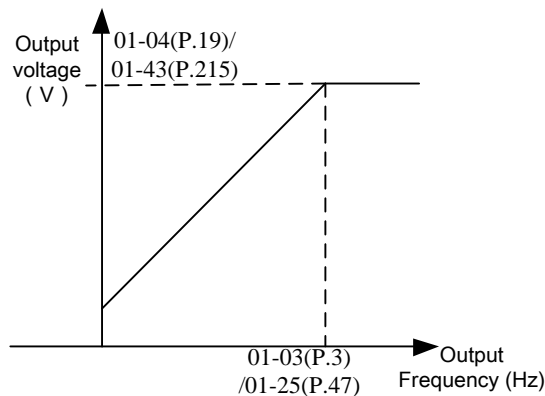

Note: For second base frequency please refer to 5.2.10 the second function.

Settin	Base voltage
--------	--------------

- ◆ When the output frequency is lower than the base frequency, the output voltage of the inverter will increase as the output frequency increases; when the output frequency reaches the base frequency (01-03(P.3)), the output voltage will reach the base voltage. If the output frequency exceeds the base frequency and still rising, the output voltage will be fixed at the base voltage.

### 5.2.3 Acceleration/deceleration time setting

- Use this function to set motor acceleration/deceleration time.

Parameter	Name	Default	Setting Range	Content
01-05 P.29	Acceleration/deceleration curve selection	0	0	Linear acceleration /deceleration curve
			1	S shape acceleration /deceleration curve 1 (Note 1)
			2	S shape acceleration /deceleration curve 2 (Note 2)
			3	S shape acceleration /deceleration curve 3 (Note 3)
01-06 P.7	Acceleration time	5.00s	0 ~ 360.00s	3.7K and types below
		20.00s	0 ~ 3600.0s	5.5K and types above
01-07 P.8	Deceleration time	5.00s	0 ~ 360.00s	3.7K and types below
		10.00s		5.5K ~ 7.5K types
		30.00s		11K and types above
01-08 P.21	Acceleration/deceleration time increments	0	0	Time increment is 0.01s
			1	Time increment is 0.1s
01-09 P.20	Acceleration/deceleration reference frequency	50.00Hz	1.00 ~ 650.00Hz	50Hz system setting (00-24(P.189)=1)
		60.00Hz		60Hz system setting(00-24(P.189)=0)

Setting Acceleration/deceleration curve selection

◆ Linear acceleration /deceleration curve (01-05(P.29)="0")

An acceleration slope is formed by the combination of 01-06(P.7) and 01-09(P.20). A deceleration slope is formed by the combination of 01-07(P.8) and 01-09(P.20).

When the target frequency varies, it increases according to the "acceleration slope" or decreases according to the "deceleration slope" linearly. See the figure below:

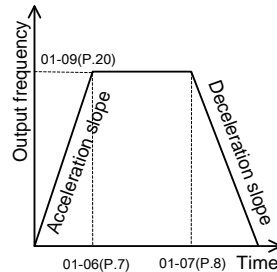

◆ S shape acceleration /deceleration curve 1 (01-05(P.29)="1")

An acceleration slope is formed by the combination of 01-06(P.7) and 01-03(P.3). A deceleration slope is formed by the combination of 01-07(P.8) and 01-03(P.3).

The acceleration / deceleration curve has an S-shape change according to the "acceleration / deceleration slope".

The S-shape equation between 0 and 01-03 (P.3) is:

$$f = [1 - \cos(\frac{90^\circ \times t}{01-06(P.7)})] \times 01-03(P.3)$$

The S-shape equation above 01-03 (P.3) is:

$$t = \frac{4}{9} \times \frac{01-06(P.7)}{01-03(P.3)^2} \times f^2 + \frac{5}{9} \times 01-06(P.7)$$

t = time; f = output frequency

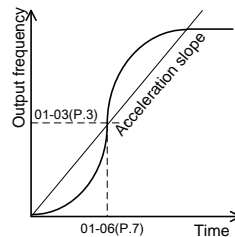

◆ S shape acceleration /deceleration curve 2 (01-05(P.29)="2")

An acceleration slope is formed by the combination of 01-06(P.7) and 01-09(P.20). A deceleration slope is formed by the combination of 01-07(P.8) and 01-09(P.20).

When the target frequency varies, the acceleration increases S-shape according to the "acceleration slope". The deceleration decreases S-shape according to the "deceleration slope". As shown in the figure below, when frequency is adjusted from f0 to f2, it accelerates S-shape once, and the time is 01-06(P.7) × (f2-f0) / 01-09(P.20). Then if the frequency is adjusted from f2 to f3, it accelerates S-shape the second time, and the time is 01-06(P.7) × (f3-f2) / 01-09(P.20)

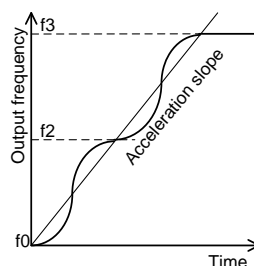

◆ S shape acceleration /deceleration curve 3 (01-05(P.29)="3")

Please refer to 5.2.12 S pattern time setting.

Settin

Acceleration/deceleration time increments

- ◆ When 01-08(P.21)=0, minimum acceleration / deceleration time ((01-06(P.7)、01-07(P.8)、01-14(P.16)、01-22(P.44)、01-23(P.45)、01-36~01-39(P.255~P.258)、04-35~04-42(P.111~P.118)、10-27~10-28(P.238~P.239)、10-36~10-37(P.276~P.277)) increment is 0.01s.
- ◆ When 01-08(P.21)=1, minimum acceleration / deceleration time ((01-06(P.7)、01-07(P.8)、01-14(P.16)、01-22(P.44)、01-23(P.45)、01-36~01-39(P.255~P.258)、04-35~04-42(P.111~P.118)、10-27~10-28(P.238~P.239)、10-36~10-37(P.276~P.277)) increment is 0.1s.

Settin

Acceleration / deceleration reference frequency

- ◆ When the output frequency of the inverter is accelerated from 0Hz to 01-09(P.20), the required time is defined as "acceleration time".
- ◆ When the output frequency of the inverter is decelerated from 0Hz to 01-09(P.20), the required time is defined as "deceleration time".

Note: 1. S shape acceleration /deceleration curve 1 is used when acceleration/deceleration is required in a short time in high-speed area equal to or higher than the base frequency, such as spindle motor.

2. S shape acceleration /deceleration curve 2 can effectively reduce motor vibration during the acceleration / deceleration, and thus prevent the belts and gears from failing.

3. S shape acceleration /deceleration curve 3 is used to start the inverter gradually without impact.

4. Please refer to Section 5.2.10 second function for the second acceleration/deceleration time.

5. When RT is "on", the second function is on. For the operation characteristics of the motor, please refer to Section 5.2.10.RT mentioned in this section is the function name of the "multi-function digital input terminal". Please refer to 03-00~03-05(P.80~P.84、P.86) for function selection and purposes of the multi-function digital input terminal. For related wiring, please refer to Section 3.5.

## 5.2.4 Torque boost V/F

- For an inverter controlled by V/F mode, when the motor starts up, the starting torque is usually insufficient since the output voltage of the inverter is low. In this case, the output voltage can be elevated by setting the torque boost 01-10(P.0) properly, and thus getting a better starting torque.

Parameter	Name	Default	Setting Range	Content
01-10 P.0	Torque boost	6.0%	0 ~ 30.0%	0.75K and below
		4.0%		1.5K ~ 3.7K
		3.0%		5.5K ~ 7.5K
		2.0%		11K ~ 22K

Settin

Torque boost

- ◆ If 01-10(P.0)=6% and 01-04(P.19)=220V, and when output frequency of the inverter is 0.2Hz, the output voltage is:

$$01-04(P.19) \times \left( \frac{100\% - 01-10(P.0)}{01-03(P.3)} \times f + 01-10(P.0) \right) = 220V \times \left( \frac{100\% - 6\%}{50Hz} \times 0.2Hz + 6\% \right) = 14.03V$$

- ◆ If RT is "on," "the second torque boost" on 01-24(P.46) is valid (Note 2).

Note: 1. If the set value of 01-10(P.0) is too high, it will activate over current protection or fail to start.

2. Please refer to Section 5.2.10 Second Function for the second torque boost.

3. RT mentioned in this section is the function name of the "multi-function digital input terminal". Please refer to 03-00~03-05(P.80~P.84、P.86) for function selection of the multi-function digital input terminal. For related wiring, please refer to Section 3.7 Terminal Wire Arrangement.

### 5.2.5 Starting frequency

➤ When the motor starts up, the instantaneous output frequency of the inverter is called “starting frequency”.

Parameter	Name	Default	Setting Range	Content
01-11 P.13	Starting frequency	0.50Hz	0 ~ 60.00Hz	Set the frequency when the starting signal is “ON”

**Settin** Starting frequency

◆ If target frequency of inverter is lower than 01-11(P.13) value, the motor will not run. When given the start signal to motor, the output frequency will go up from the value of 01-11(P.13).

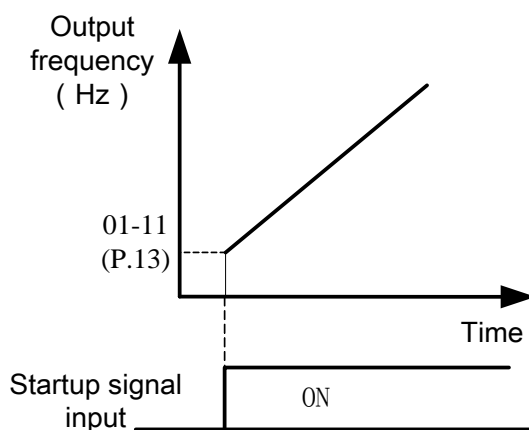

### 5.2.6 Load pattern selectionV/F

➤ In V/F control, you can choose the best output characteristics for different applications and load.

Parameter	Name	Default	Setting Range	Content
01-12 P.14	Load pattern selection	0	0	For constant torque loads (conveyor belt, etc.)
			1	For variable torque loads (fans and pumps, etc.)
			2~3	For Lifting loads
			4	Multipoint V/F curve
			5 ~ 13	Special two-point V/F curve
			14	V/F complete detached mode
			15	V/F semidetached mode

**Settin** Applicable load pattern selection

◆ When **01-12(P.14) = 4**, suppose that 01-04(P.19)=220V, 01-26(P.98)=5Hz, 01-27(P.99)=10%, when the inverter is running at 5Hz, the output voltage equals to  $01-04(P.19) \times 01-27(P.99) = 220V \times 10\% = 22V$ .

◆ If RT is “on”, **the second function is valid. Please refer to section 5.2.10 Second Function.**

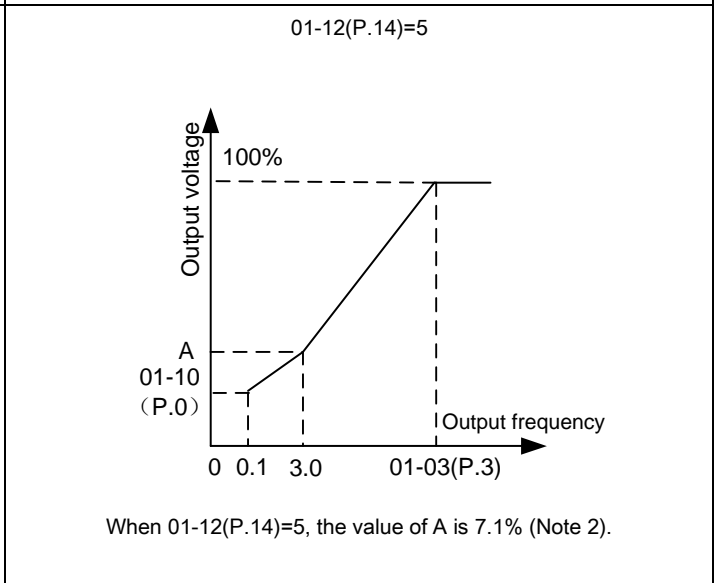
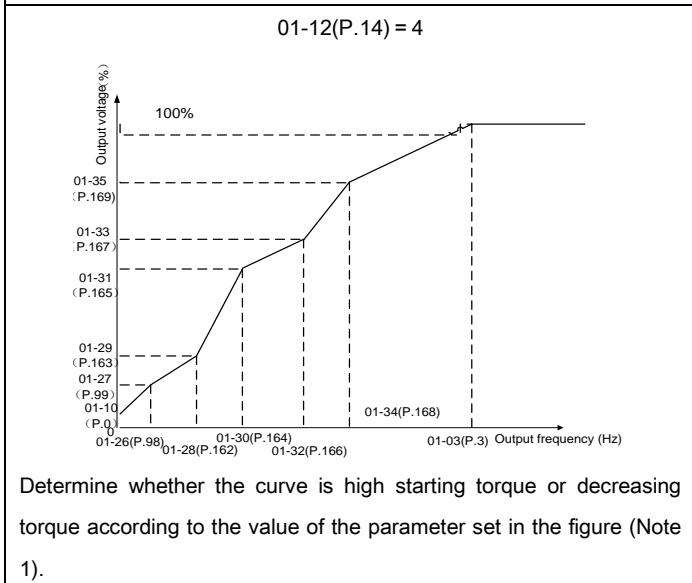
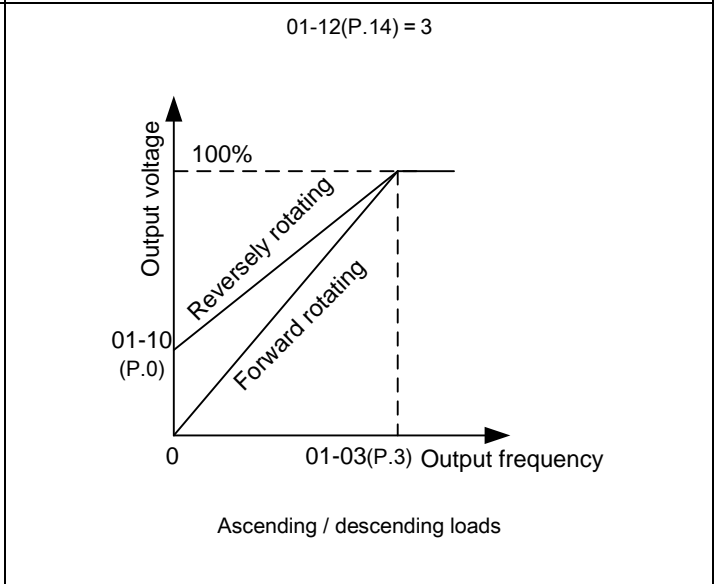
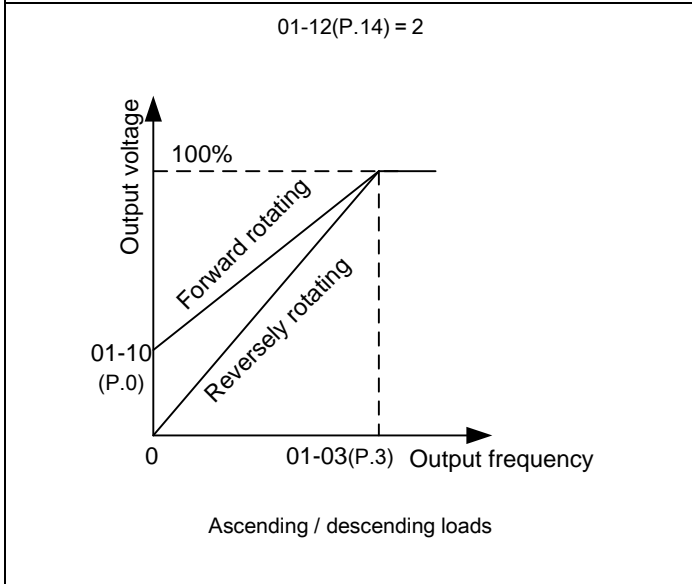
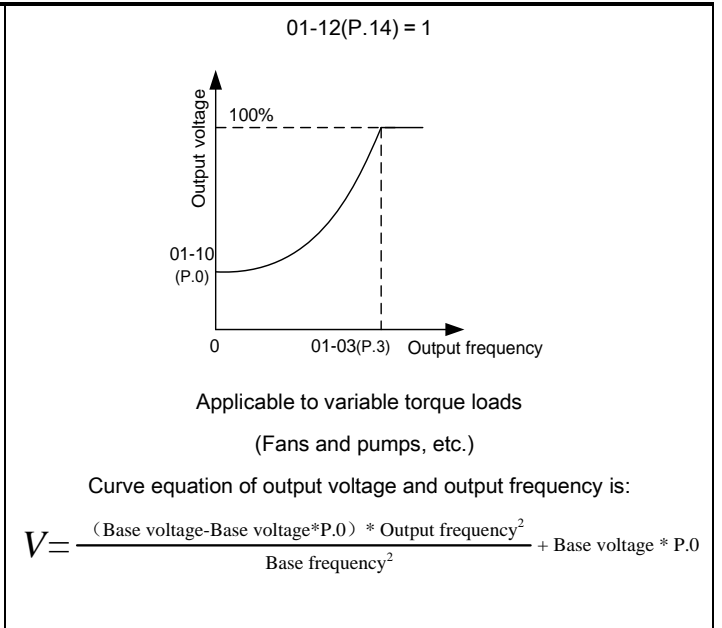
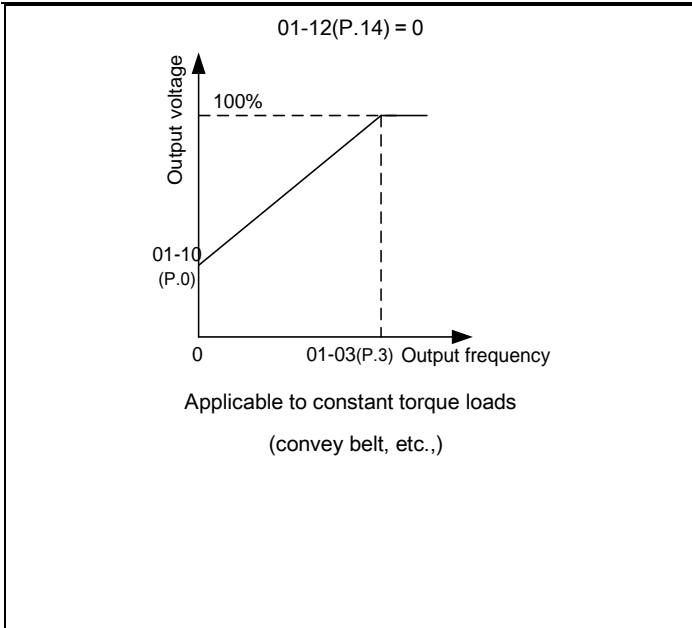

## Basic parameter group 01

<p>01-12(P.14) = 6, 7, 8</p> <p>When 01-12(P.14)=6, the value of A is 8.7%. When 01-12(P.14)=7, the value of A is 10.4%. When 01-12(P.14)=8, the value of A is 12.0%.(Note 2)</p>	<p>01-12(P.14) = 9, 10</p> <p>When 01-12(P.14)=9, the value of A is 20.0%. When 01-12(P.14)=10, the value of A is 25.0%.(Note 2)</p>
<p>01-12(P.14) = 11, 12, 13</p> <p>When 01-12(P.14)= 11, the value of A is 9.3%. When 01-12(P.14) = 12, the value of A is 12.7%. When 01-12(P.14) = 13, the value of A is 16.1%. (Note 2)</p>	

Note: 1. Referring to the diagrams above, set 01-26(P.98) and 01-27(P.99) if one point is needed. Set 01-26(P.98), 01-27(P.99), 01-28(P.162) and 01-29(P.163) if two points are needed. 01-26(P.98), 01-27(P.99), 01-28(P.162), 01-29(P.163), 01-30(P.164) and 01-31(P.165) if three points are needed.

2. When set 01-12(P.14) between 5 and 13, if 01-10(P.0) is larger than the point A, point A equals to 01-10(P.0).

### ◆ VF complete separation (01-12(P.14)="14")

In this mode, the output frequency and output voltage of the AC drive are independent. The output frequency is determined by the frequency source(00-16(P.79)), and the output voltage is determined by "Voltage source for V/F separation" (10-40(P.700)).For the details, please refer to Section 5.11.13 V/F complete separation.

### ◆ V/F half separation (01-12(P.14)="15")

In this mode, V and F are proportional and the proportional relationship can be set by external analog terminal or M2 terminal. The relationship between V and F are also related to the rated motor voltage and rated motor frequency.

In this mode, the relationship between V and F is:  $V/F=2*X*(\text{rated motor voltage})/(\text{rated motor frequency})$ .

X is set by external analog terminal function, and the range is 0-100%.

Note: VF curve separation is suitable for all kinds of variable frequency power supply occasions, but the user must be careful when setting and adjusting parameters, inappropriate settings may cause damage to the machine.



### 5.2.7 JOG run

- The frequency and acceleration/deceleration time for JOG running can be set. JOG can be used for conveyor positioning, test run, etc.

Parameter	Name	Default	Setting Range	Content
01-13 P.15	JOG frequency	5.00Hz	0 ~ 650.00Hz	Set the frequency during JOG operation
01-14 P.16	JOG acceleration/ deceleration time	0.50s	0 ~ 360.00s/ 0 ~ 3600.0s	01-08(P.21)=0/ 01-08(P.21)=1

#### Setting JOG operation

- ◆ In JOG mode, the output frequency is the set value of 01-13(P.15), and the acceleration / deceleration time is the set value of 01-14(P.16).

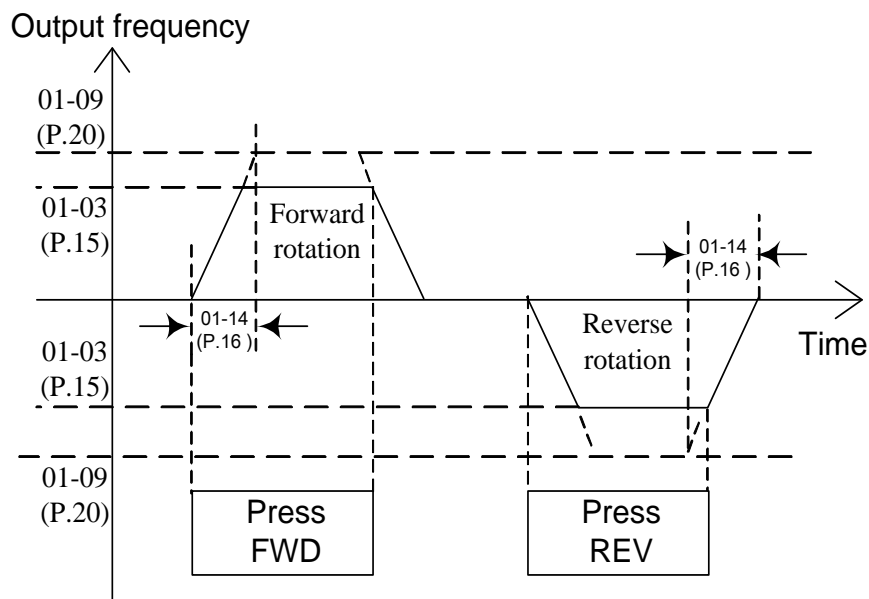

Note: Please refer to Section 4.3.3 for how to enter the JOG mode.

### 5.2.8 Output frequency filter time

- This filter can reduce the impact when switching the frequency between high and low, and thus reduce the vibration of machine

Parameter	Name	Default	Setting Range	Content
01-15 P.28	Output frequency filter time	0ms	0 ~ 1000ms	---

#### Setting Output frequency filter time

- ◆ The filtering effect is better when the value of 01-15(P.28) is larger, but will also increase the response delay.  
◆ If 01-15(P.28) is set to 0, the filtering function is off.

## 5.2.9 Frequency jump

➤ To avoid resonance from a mechanical system, these parameters allow jumping through resonant frequencies.

Parameter	Name	Default	Setting Range	Content
01-16 P.91	Frequency jump 1A	99999	0 ~ 650.00Hz	---
			99999	Invalid.
01-17 P.92	Frequency jump 1B	99999	0 ~ 650.00Hz	---
			99999	Invalid.
01-18 P.93	Frequency jump 2A	99999	0 ~ 650.00Hz	---
			99999	Invalid.
01-19 P.94	Frequency jump 2B	99999	0 ~ 650.00Hz	---
			99999	Invalid.
01-20 P.95	Frequency jump 3A	99999	0 ~ 650.00Hz	---
			99999	Invalid.
01-21 P.96	Frequency jump 3B	99999	0 ~ 650.00Hz	---
			99999	Invalid.

### Setting Frequency jump

◆ To avoid system's mechanical resonance frequency when running the motor, the inverter provides three sets of jump frequencies: 001-16(P.91) and 01-17(P.92) (the first set), 01-18(P.93) and 01-19(P.94) (the second set), 01-20(P.95) and 01-21(P.96) (the third set)

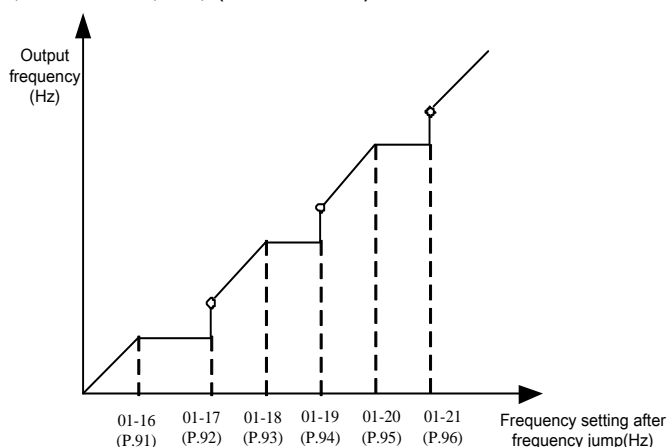

◆ For example: assuming 01-16(P.91)=45 and 01-17(P.92)=50;  
 If the target frequency  $\leq 45$ Hz, then the steady output frequency = the target frequency.  
 If  $45\text{Hz} \leq \text{target frequency} < 50$ Hz, then the steady output frequency = 45Hz.  
 If the target frequency  $\geq 50$ Hz, then the steady output frequency = the target frequency.

Note: 1. During acceleration / deceleration, output frequency of inverter will pass through the jump frequency.  
 2. When 01-16(P.91)=99999 or 01-17(P.92)=99999, the first set of frequency jump is invalid.  
 When 01-18(P.93)=99999 or 01-19(P.94)=99999, the second set of frequency jump is invalid.  
 When 01-20(P.95)=99999 or 01-21(P.96)=99999, the third set of frequency jump is invalid.

## 5.2.10 Second function

➤ When given RT signal, these parameters will work.

Parameter	Name	Default	Setting Range	Content
01-22 P.44	Second acceleration time	99999	0 ~ 360.00s/ 0 ~ 3600.0s	01-08=0/ 01-08=1
			99999	Off
01-23 P.45	Second deceleration time	99999	0 ~ 360.00s/ 0 ~ 3600.0s	01-08(P.21)=0/ 01-08(P.21)=1
			99999	Off
01-24 P.46	Second torque boost	99999	0 ~ 30.0%	---
			99999	Off
01-25 P.47	Second base frequency	99999	0 ~ 650.00Hz	---
			99999	Off
01-43 P.215	Second base voltage	99999	0 ~ 1000.0V	Set base voltage according to motor rated value
			99999	Base voltage equals to power voltage

Setting Second function

- ◆ When 01-08(P.21)=0, minimum acceleration / deceleration time (01-22(P.44), 01-23(P.45)) increment is 0.01s.
- ◆ When 01-08(P.21)=1, minimum acceleration / deceleration time (01-22(P.44), 01-23(P.45)) increment is 0.1s.
- ◆ When RT is “on”, second function is valid. For the motor operation characteristics, please refer to the following second function setting.

If 01-22(P.44)≠99999 and 01-23(P.45)=99999, when RT is “on”, acceleration /deceleration time is the “set value of 01-22(P.44)”.

If 01-22(P.44)≠99999 and 01-23(P.45)≠99999, when RT is “on”, acceleration time is the “set value of 01-22(P.44)” and deceleration time is the “set value of 01-23(P.45)”.

If 01-22(P.44)≠99999 and 01-24(P.46)=99999, when RT is “on”, torque boost is the “set value of 01-10(P.0)”.

If 01-22(P.44)≠99999 and 01-24(P.46)≠99999, when RT is “on”, torque boost is the “set value of 01-24(P.46)”.

If 01-22(P.44)≠99999 and 01-25(P.47)=99999, when RT is “on”, base frequency is the “set value of 01-03(P.3)”.

If 01-22(P.44)≠99999 and 01-25(P.47)≠99999, when RT is “on”, base frequency is the “set value of 01-25(P.47)”.

If 01-43(P.215)=99999, when RT is “on”, base voltage equals to power voltage.

01-43(P.215)≠99999, when RT is “on”, if the value of voltage set by 01-43(P.215) is lower than power voltage, base voltage is the “set value of 01-43(P.215)”; if the value of voltage is higher than power voltage, base voltage is the power voltage.

Note: RT mentioned here is the function name of “multi-function digital input terminal”. Please refer to 03-00~03-05(P.80~P.84、P.86) for function selection of multi-function digital input terminal; please refer to Section 3.5 Terminal Wire Arrangement.

## 5.2.11 Middle frequency, output voltage of middle frequency V/F

➤ Parameters can be set when using special motors, especially to adjust motor torque.

Parameter	Name	Default	Setting Range	Content
01-26 P.98	Middle frequency 1	3.00Hz	0 ~ 650.00Hz	---
01-27 P.99	Output voltage 1 of middle frequency	10.0%	0 ~ 100.0%	---
01-28 P.162	Middle frequency 2	99999	0 ~ 650.00Hz	---
			99999	Off
01-29 P.163	Output voltage 2 of middle frequency	0.0%	0 ~ 100.0%	---
01-30 P.164	Middle frequency 3	99999	0 ~ 650.00Hz	---
			99999	Off
01-31 P.165	Output voltage 3 of middle frequency	0.0%	0 ~ 100.0%	---
01-32 P.166	Middle frequency 4	99999	0 ~ 650.00Hz	---
			99999	Off
01-33 P.167	Output voltage 4 of middle frequency	0.0%	0 ~ 100.0%	---
01-34 P.168	Middle frequency 5	99999	0 ~ 650.00Hz	---
			99999	Off
01-35 P.169	Output voltage 5 of middle frequency	0.0%	0 ~ 100.0%	---

 Middle frequency, output voltage of middle frequency

◆ Please refer to the description for **01-12(P.14)=4** in **Section 5.2.6 Applicable load pattern selection.**

## 5.2.12 S pattern time

➤ It is used to set the acceleration time of S pattern acceleration/deceleration.

Parameter	Name	Default	Setting Range	Content
01-36 P.255	S curve time at the beginning of acceleration	0.20s	0 ~ 25.00s/ 0 ~ 250.0s	01-08(P.21)=0/ 01-08(P.21)=1
			99999	01-08(P.21)=0/ 01-08(P.21)=1
01-37 P.256	S curve time at the end of acceleration	99999	0 ~ 25.00s/ 0 ~ 250.0s	01-08(P.21)=0/ 01-08(P.21)=1
			99999	Not selected.
01-38 P.257	S curve time at the beginning of deceleration	99999	0 ~ 25.00s/ 0 ~ 250.0s	01-08(P.21)=0/ 01-08(P.21)=1
			99999	Not selected.
01-39 P.258	S curve time at the end of deceleration	99999	0 ~ 25.00s/ 0 ~ 250.0s	01-08(P.21)=0/ 01-08(P.21)=1
			99999	Not selected.

Settin

 S pattern time

- ◆ When 01-05(P.29) = 3, “S pattern acceleration /deceleration curve 3”.

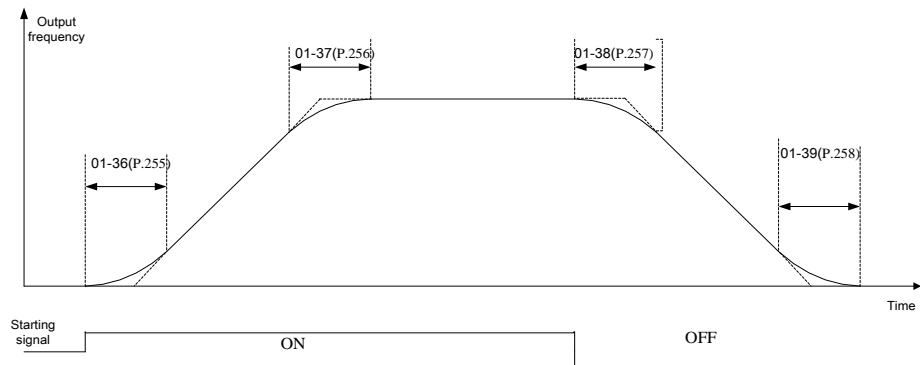

- 1) Parameters 01-36(P.255), 01-37(P.256), 01-38(P.257) and 01-39(P.258) are used to start inverter gradually without impact. And adjust the value to vary degrees of S shape acceleration / deceleration curve. When the S shape acceleration / deceleration curve is started, the inverter will accelerate/decelerate with different speed according to the primary acceleration/deceleration time.
- 2) When S shape acceleration/deceleration curve 3 is selected, the acceleration/ deceleration time will be longer, as follows
- 3) When the selected acceleration time (01-06(P.7) or 01-22(P.44))  $\geq$  01-36(P.255) and 01-37(P.256), the actual acceleration time is as follows:

Actual acceleration time = the selected acceleration time + (01-36(P.255) + 01-37(P.256)) / 2

When the selected deceleration time (01-07(P.8) or 01-23(P.45))  $\geq$  01-38(P.257) and 01-39(P.258), the actual deceleration time is as follows:

Actual deceleration time = the selected deceleration time + (01-38(P.257) + 01-39(P.258)) / 2

- ◆ Example: when the parameters are in default value (60 Hz system), the actual acceleration time from 0Hz to 60Hz in accordance with S shape acceleration/deceleration curve 3 is as follows:

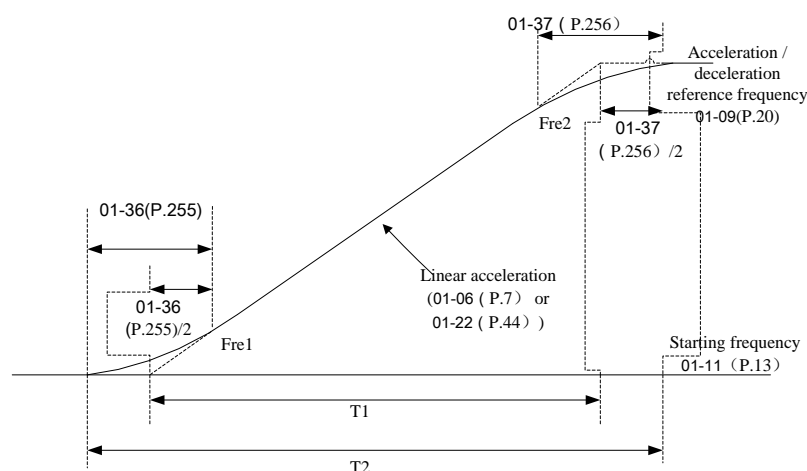

Set acceleration time  $T1 = (01-09(P.20) - 01-11(P.13)) * 01-06(P.7) / 01-09(P.20)$

Actual acceleration time  $T2 = T1 + (01-36(P.255) + 01-37(P.256)) * (01-09(P.20) - 01-11(P.13)) / 2 / 01-09(P.20)$

So  $T1 = (60 - 0.5) * 5 / 60 = 4.96s$  (the actual acceleration time of linear acceleration)

Actual acceleration time  $T2 = 4.96 + (0.2 + 0.2) * (60 - 0.5) / 2 / 60 = 5.16s$

Note: All calculations of acceleration/deceleration time are based on 01-09(P.20).

## 5.2.13 Remote Control Frequency Acc/Dec Time Selection

➤ Parameters can be used to select remote control function RM, RH in order to modify the accele

Parameter	Name	Default	Setting Range	Content
01-40	Remote function	0	0	Use default acc/dec time ( same as regular mode )
P.219	acc/dec time selection		1	Use second acc/dec time

Setting Remote control frequency acceleration and deceleration time selection

01-40 (P.219) = 0, the acceleration and deceleration time of the remote control frequency is the current acceleration and deceleration time (the same as the acceleration and deceleration time of the output frequency);

◆ When 01-40 ( P.219 ) = 1,

If 01-22 ( P.44 ) ≠ 99999 , 01-23 ( P.45 ) = 99999 , The acceleration time and deceleration of the remote control frequency are both "01-22 (P.44) set value" ;

If 01-22 ( P.44 ) ≠ 99999 , 01-23 ( P.45 ) ≠ 99999 , The acceleration time of the remote control frequency is "01-22 (P.44) setting value", and the deceleration time is "01-23 (P.45) setting value" ;

If 01-22 ( P.44 ) = 99999 , the acceleration and deceleration time of the remote control frequency is the current acceleration and deceleration time (the same as the acceleration and deceleration time of the output frequency).

## 5.3 Analog input and output parameter group 02

Group	Parameter Number	Name	Setting Range	Default	Page
02-00	P.500	Terminal 2-5 input function	0: Off	1	<u>98</u>
			1: Frequency command		
			2: Torque command		
			3: PID target value		
			4: PID feedback signal		
			5: Tension target value		
			6: Line speed		
			7: Line speed feedback		
			8: Real-time roll diameter		
			9: Initial roll diameter		
			10: Material thickness		
			11: PTC thermistor		
			12: PT100 thermistor		
			13: VF separate function		
			14: Positive torque limit		
			15: Negative torque limit		
			16: Positive/Negative torque limit		
17: Regenerative torque limit					
02-01	P.501	Terminal 4-5 input function	Same as 02-00	1	<u>98</u>
02-03	P.503	Terminal HDI input function	Same as 02-00	0	<u>98</u>
02-04	P.54	Terminal AM output function	0: Output frequency, use 02-51 (P.55) value as 100%.	0	<u>99</u>
			1: Output current, use 02-52 (P.56) value as 100%.		
			2: Output DC bus voltage, use the OV trigger voltage as 100%.		
			3: Output inverter temperature accumulate rising rate, use NTC trigger level as 100%.		
			4: Output inverter thermal relay accumulate rate, use the digital thermal relay trigger level ( 06-00 ( P.9 ) ≠ 0 ) or the thermal relay on IGBT trigger level ( 06-00 (P.9) = 0) as 100%.		
			5: Target frequency, use 02-51(P.55) value as 100%.		
			6: Fixed output, voltage or current output level can be set by 02-54 (P.541)		
			7: Output voltage, use inverter rated voltage as 100%		
			8: Excitation current, use motor rated current as 100%. (Valid only when 00-21(P.300) or 00-22 (P.370) is set to 3~6)		

Analog input and output parameter group 02

Group	Parameter Number	Name	Setting Range	Default	Page
02-04	P.54	Terminal AM output function	9: Output torque, use two times motor rated torque as 100%.(Valid only when 00-21 (P.300) or 00-22 (P.370) is set to 3~6)	0	<u>99</u>
			10: Output power, use two times motor rated power as 100%.		
			11: High-speed pulse input, use 100KHz as 100%.		
			12: Motor speed, use 02-51 (P.55) as 100%		
			13 : PLC analog output, for details please refer to SA3 built-in PLC manual		
02-06	P.185	Proportion linkage gain	0 ~ 100%	0%	<u>100</u>
02-07	P.240	Auxiliary frequency	0: Off	0	<u>101</u>
			1: Output frequency = basic frequency + auxiliary frequency (given by terminal 2-5)		
			2: Output frequency = basic frequency + auxiliary frequency (given by terminal 4-5)		
			3: Output frequency = basic frequency - auxiliary frequency (given by terminal 2-5)		
			4: Output frequency = basic frequency - auxiliary frequency (given by 4-5 terminal)		
			5: Output frequency = proportional linkage signal (given by terminal 2-5)		
			6: Output frequency = proportional linkage signal (given by terminal 4-5)		
02-08	P.73	Terminal 2-5 signal range selection	0: Signal sampling range from 0 ~5V.	1	<u>101</u>
			1: Signal sampling range from 0 ~10V.		
			2: Signal sampling range from 0 ~ -5V.		
			3: Signal sampling range from 0 ~ -10V.		
			4: Signal sampling range from -5 ~ +5V.		
			5: Signal sampling range from -10 ~ +10V.		
02-09	P.38	Terminal 2-5 maximum running frequency	50Hz system: 1.00 ~ 650.00Hz	50.00Hz	<u>102</u>
			60Hz system: 1.00 ~ 650.00Hz	60.00Hz	
02-10	P.60	Terminal 2-5 filter time	0 ~ 2000ms	30ms	<u>102</u>
02-11	P.139	Terminal 2-5 voltage signal bias rate	-100.0%~100.0%	0.0%	<u>102</u>
02-12	P.192	Terminal 2-5 minimum input positive voltage	0 ~ 10.00V	0.00V	<u>102</u>
02-13	P.193	Terminal 2-5 maximum input positive voltage	0 ~ 10.00V	10.00V	<u>102</u>
02-14	P.194	Percentage corresponds to terminal 2-5 minimum positive voltage	-100.0% ~ 100.0%	0.0%	<u>102</u>
			-400.0% ~ 400.0%(02-00(P.500)= 2/14/15/16/17)		



Group	Parameter Number	Name	Setting Range	Default	Page
02-15	P.195	Percentage corresponds to terminal 2-5 maximum positive voltage	-100.0% ~ 100.0%	100.0%	<a href="#">102</a>
			-400.0% ~ 400.0%(02-00(P.500)= 2/14/15/16/17)		
02-16	P.512	Terminal 2-5 minimum input negative voltage	0 ~ 10.00V	0.00V	<a href="#">102</a>
02-17	P.513	Terminal 2-5 maximum input negative voltage	0 ~ 10.00V	0.00V	<a href="#">102</a>
02-18	P.510	Percentage corresponds to terminal 2-5 minimum negative voltage	-100.0% ~ 100.0%	0.0%	<a href="#">102</a>
			-400.0% ~ 400.0%(02-00(P.500)= 2/14/15/16/17)		
02-19	P.511	Percentage corresponds to terminal 2-5 maximum negative voltage	-100.0% ~ 100.0%	0.0%	<a href="#">102</a>
			-400.0% ~ 400.0%(02-00(P.500)= 2/14/15/16/17)		
02-20	P.17	Terminal 4-5 signal range selection	0: Signal sampling range from 4~20mA.	0	<a href="#">107</a>
			1: Signal sampling range from 0 ~ 10V.		
			2: Signal sampling range from 0 ~ 5V.		
02-21	P.39	Terminal 4-5 maximum operation frequency	50Hz system: 1.00 ~ 650.00Hz	50.00Hz	<a href="#">107</a>
			60Hz system: 1.00 ~ 650.00Hz	60.00Hz	
02-22	P.528	Terminal 4-5 filter time	0 ~ 2000ms	30ms	<a href="#">107</a>
02-23	P.505	Terminal 4-5 current/ voltage signal bias rate	-100.0% ~ 100.0%	0.0%	<a href="#">107</a>
02-24	P.184	Terminal 4-5 disconnect selection	0: Off	0	<a href="#">108</a>
			1: Inverter decelerates to 0Hz, multi-function digital output terminal set off alarm		
			2: Inverter stops immediately, and keypad displays "AEr" alarm		
			3: Inverter runs continuously according to the frequency command before disconnection. Digital output terminal will set off alarm.		
02-25	P.198	Terminal 4-5 minimum input current/ voltage	0 ~ 20.00mA	4.00mA	<a href="#">108</a>
02-26	P.199	Terminal 4-5 maximum input current/ voltage	0 ~ 20.00mA	20.00mA	<a href="#">108</a>
02-27	P.196	Percentage corresponds to terminal 4-5 minimum input current/ voltage	-100.0% ~ 100.0%	0.0%	<a href="#">108</a>
			-400.0% ~ 400.0%(02-00(P.500)= 2/14/15/16/17)		

Analog input and output parameter group 02

Group	Parameter Number	Name	Setting Range	Default	Page
02-28	P.197	Percentage corresponds to terminal 4-5 maximum input current/ voltage	-100.0% ~ 100.0%	100.0%	<a href="#">108</a>
			-400.0% ~ 400.0%(02-00(P.500)= 2/14/15/16/17)		
02-38	P.526	Terminal HDI filter time	0 ~ 2000ms	10ms	<a href="#">109</a>
02-39	P.524	Terminal HDI minimum input frequency	0 ~ 100.00kHz	0.00kHz	<a href="#">109</a>
02-40	P.525	Terminal HDI maximum input frequency	0 ~ 100.00kHz	100.00 kHz	<a href="#">109</a>
02-41	P.522	Percentage corresponds to terminal HDI minimum input frequency	-100.0% ~ 100.0%	0.0%	<a href="#">109</a>
			-400.0% ~ 400.0%(02-00(P.500)= 2/14/15/16/17)		
02-42	P.523	Percentage corresponds to terminal HDI maximum input frequency	-100.0% ~ 100.0%	100.0%	<a href="#">109</a>
			-400.0% ~ 400.0%(02-00(P.500)= 2/14/15/16/17)		
02-43	P.74	Terminal HDO clock multiplier factor	0: Select FM function as the output function of terminal HDO.	0	<a href="#">110</a>
			1 ~ 9000: factor for square-wave pulse output frequency. Value in 02-43 (P.74) times output frequency will be actual output pulse frequency.		
02-44	P.543	Terminal FM output function selection	0: Output frequency, use 02-51 (P.55) value as 100%.	0	<a href="#">111</a>
			1: Output current, use 02-52 (P.56) value as 100%.		
			2: Output DC bus voltage, use the OV trigger voltage as 100%.		
			3: Output inverter temperature accumulate rising rate, use NTC trigger level as 100%.		
			4: Output inverter thermal relay accumulate rate, use the digital thermal relay trigger level ( 06-00 ( P.9 ) ≠ 0 ) or the thermal relay on IGBT trigger level ( 06-00 (P.9) = 0) as 100%.		
			5: Target frequency, use 02-51(P.55) value as 100%.		
			6: Fixed output, voltage or current output level can be set by 02-54 (P.541)		
			7: Output voltage, use inverter rated voltage as 100%		
			8: Excitation current, use motor rated current as 100%. (Valid only when 00-21(P.300) or 00-22 (P.370) is set to 3~6)		
			9: Output torque, use two times motor rated torque as 100%.(Valid only when 00-21 (P.300) or 00-22 (P.370) is set to 3~6)		

Group	Parameter Number	Name	Setting Range	Default	Page
02-44	P.543	Terminal FM output function selection	10: Output power, use two times motor rated power as 100%.	0	<a href="#">111</a>
			11: High-speed pulse input, use 100KHz as 100%.		
			12: Motor speed, use 02-51 (P.55) as 100%		
02-45	P.64	Terminal AM output signal selection	0: Output 0~10V across terminal AM-5.	0	<a href="#">111</a>
			1: Reserved		
			2: Output 0~20mA across AM-5.		
			3: Output 4~20mA across AM-5.		
02-46	P.191	Terminal AM output gain	0 ~ 1024	935	<a href="#">111</a>
02-47	P.190	Terminal AM output bias	0 ~ 1024	0	<a href="#">111</a>
02-51	P.55	Maximum analog output frequency reference	50Hz system: 1.00 ~ 650.00Hz	50.00Hz	<a href="#">113</a>
			60Hz system: 1.00 ~ 650.00Hz	60.00Hz	
02-52	P.56	Maximum analog output current reference	0~500.00A	According to type	<a href="#">113</a>
02-54	P.541	Terminal AM/FM fixed output level	0 ~ 100.0%	0.0%	<a href="#">113</a>
02-55	P.592	PT100 thermistor voltage level 1	0 ~ 10.00V	5.00V	<a href="#">113</a>
02-56	P.593	PT100 thermistor voltage level 2	0 ~ 10.00V	7.00V	<a href="#">113</a>
02-57	P.594	PT100 thermistor level 1 frequency	0 ~ 650.00Hz	0.00Hz	<a href="#">113</a>
02-58	P.595	PT100 thermistor level 1 delay time	0 ~ 6000s	60s	<a href="#">113</a>
02-59	P.187	FM calibration coefficient	0 ~ 9998	450	<a href="#">114</a>

5.3.1 Analog input terminals and M2 terminal function selection

➤ Input function selection of terminal 2,4 and M2

Parameter	Name	Default	Setting Range	Content
02-00 P.500	Terminal 2-5 input function	1	0	Off
			1	Frequency command
			2	Torque command
			3	PID target value
			4	PID feedback signal
			5	Tension target value
			6	Line speed
			7	Line speed feedback
			8	Real-time roll diameter
			9	Initial roll diameter
			10	Material thickness
			11	PTC thermistor
			12	PT100 thermistor
			13	VF separate function
			14	Positive torque limit
			15	Negative torque limit
			16	Positive/Negative torque limit
17	Regenerative torque limit			
02-01 P.501	Terminal 4-5 input function	1	Same as 02-00(P.500)	Same as 02-00(P.500)
02-03 P.503	Terminal HDI input function	0	Same as 02-00(P.500)	Same as 02-00(P.500)

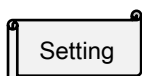
 Input function selection

- ◆ When set to 1 frequency command, 0 ~ ±10V / 4~20mA corresponds to 0~ maximum output frequency.
- ◆ HDI is sharing terminal with M2 and default to M2 terminal function, set parameter 03-05(P.82) to 41、54、57 as HDI function.

Note: The default priority level is 2-5 > 4-5 >M2

## 5.3.2 Analog output terminals AM function selection

- Selects the monitor item for analog output terminal AM.

Parameter	Name	Default	Setting Range	Content
02-04 P.54	Terminal AM output function	0	0	Output frequency, use 02-51 (P.55) value as 100%.
			1	Output current, use 02-52 (P.56) value as 100%.
			2	Output DC bus voltage, use the OV trigger voltage as 100%.
			3	Output inverter temperature accumulate rising rate, use NTC trigger level as 100%.
			4	Output inverter thermal relay accumulate rate, use the digital thermal relay trigger level ( 06-00 ( P.9 ) $\neq$ 0 ) or the thermal relay on IGBT trigger level ( 06-00 (P.9) = 0) as 100%.
			5	Target frequency, use 02-51(P.55) value as 100%.
			6	Fixed output, voltage or current output level can be set by 02-54 (P.541)
			7	Output voltage, use inverter rated voltage as 100%
			8	Excitation current, use motor rated current as 100%. (Valid only when 00-21(P.300) or 00-22 (P.370) is set to 3~6)
			9	Output torque, use two times motor rated torque as 100%. (Valid only when 00-21 (P.300) or 00-22 (P.370) is set to 3~6)
			10	Output power, use two times motor rated power as 100%.
			11	High-speed pulse input, use 100KHz as 100%.
			12	Motor speed, use 02-51 (P.55) as 100%
13	PLC analog output, for details please refer to SA3 built-in PLC manual			

**Setting** Usage of analog output terminal AM

- ◆ For the voltage/current calibration of terminal AM, please refer to calibration parameter in section **5.3.10** output terminal AM signal selection and processing.

### 5.3.3 Proportional linkage gain

- This function is used to multiply frequency command from external analog input terminal. When multiple inverters are running in proportion, it is effective to use this function to fine-tune the frequency command from master inverter to slave inverter.

Parameter	Name	Default	Setting Range	Content
02-06 P.185	Proportional linkage gain	0%	0 ~ 100%	---

**Setting** Proportional linkage gain

- ◆ When output frequency is lower than 01-01(P.2), it is equal to lower limit frequency 01-01(P.2).  
When output frequency is higher than 01-00(P.1), it is equal to upper limit frequency 01-00(P.1).
- ◆ After multiplying the setting frequency by 02-06(P.185) value, add and subtract can be performed as follows:  
For example: When the setting frequency is 50Hz, 02-06(P.185)=50% and the external analog input signal is 0~10V.

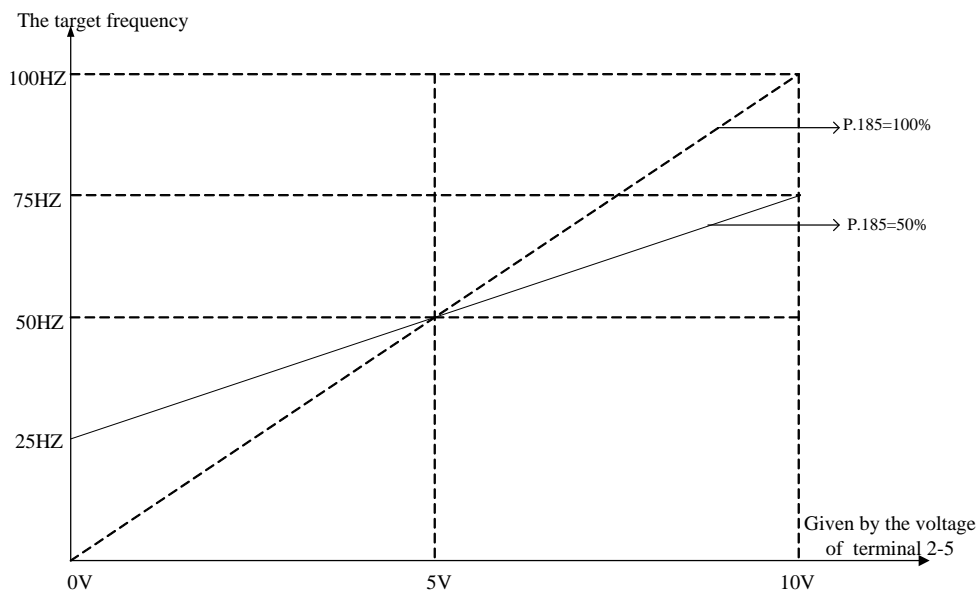

In the above figure, when 0V is given, the target frequency is  $50\text{Hz} - (50\text{Hz} \times 50\%) = 25\text{Hz}$ ;

when 5V is given, the target frequency is  $50\text{Hz} - (50\text{Hz} \times 0\%) = 50\text{Hz}$ ;

when 10V is given, the target frequency is  $50\text{Hz} + (50\text{Hz} \times 50\%) = 75\text{Hz}$ .

Note: 1. For proportional linkage signal input, please refer to the description of parameter 02-07 (P.240).  
2. When use terminal 4-5 analog (voltage/current) signal as proportional linkage signal input terminal, please refer to parameter 02-20(P.17); for the setting of external analog signal frequency range, please refer to parameter 02-09(P.38), 02-21(P.39), 02-20(P.17), 02-08(P.73).

### 5.3.4 Auxiliary frequency

- Frequency can be adjusted and synthesized flexibly to meet the different control requirements in different scenarios.

Parameter	Name	Default	Setting Range	Content
02-07 P.240	Auxiliary frequency	0	0	Off
			1	Output frequency = basic frequency + auxiliary frequency (given by terminal 2-5)
			2	Output frequency = basic frequency + auxiliary frequency (given by terminal 4-5)
			3	Output frequency = basic frequency - auxiliary frequency (given by terminal 2-5)
			4	Output frequency = basic frequency - auxiliary frequency (given by 4-5 terminal)
			5	Output frequency = proportional linkage signal (given by terminal 2-5)
			6	Output frequency = proportional linkage signal (given by terminal 4-5)

 Setting Auxiliary frequency

- ◆ When output frequency is lower than 01-01(P.2), it equals to lower limit frequency 01-01(P.2).

When output frequency is higher than 01-00(P.1), it equals to upper limit frequency 01-00(P.1).

Note: 1. Basic frequency command is given by keypad, communication or multi-speed terminal.

2. For proportional linkage signals, please refer to the description of parameter 02-06(P.185).

3. When use terminal 4-5 analog (voltage/current) signal as proportional linkage signal input terminal, please refer to parameter 02-20(P.17); for the setting of external analog signal frequency range, please refer to parameter 02-09(P.38) , 02-21(P.39) , 02-20(P.17) , 02-08(P.73).

### 5.3.5 Terminal 2-5 signal selection and processing

- Choose terminal 2-5 signal specifications, frequency compensation function, and signal polarity .etc.

Parameter	Name	Default	Setting Range	Content
02-08 P.73	Terminal 2-5 signal range selection	1	0	0: Signal sampling range from 0 ~5V.
			1	1: Signal sampling range from 0 ~10V.
			2	2: Signal sampling range from 0 ~ -5V.
			3	3: Signal sampling range from 0 ~ -10V.
			4	4: Signal sampling range from -5 ~ +5V.
			5	5: Signal sampling range from -10 ~ +10V.

## Analog input and output parameter group 02

Parameter	Name	Default	Setting Range	Content
02-09 P.38	Terminal 2-5 maximum running frequency	50.00Hz	1.00 ~ 650.00Hz	50Hz system(00-24(P.189)=1)
		60.00Hz		60Hz system(00-24(P.189)=0)
02-10 P.60	Terminal 2-5 filter time	30ms	0 ~ 2000ms	---
02-11 P.139	Terminal 2-5 voltage signal bias rate	0.0%	-100.0%~100.0%	---
02-12 P.192	Terminal 2-5 minimum input positive voltage	0.00V	0 ~ 10.00V	---
02-13 P.193	Terminal 2-5 maximum input positive voltage	10.00V	0 ~ 10.00V	---
02-14 P.194	Percentage corresponds to terminal 2-5 minimum positive voltage	0.0%	-100.0% ~ 100.0%	---
			-400.0% ~ 400.0%	( 02-00(P.500)= 2/14/15/16/17 )
02-15 P.195	Percentage corresponds to terminal 2-5 maximum positive voltage	100.0%	-100.0% ~ 100.0%	---
			-400.0% ~ 400.0%	( 02-00(P.500)= 2/14/15/16/17 )
02-16 P.512	Terminal 2-5 minimum input negative voltage	0.00V	0 ~ 10.00V	---
02-17 P.513	Terminal 2-5 maximum input negative voltage	0.00V	0 ~ 10.00V	---
02-18 P.510	Percentage corresponds to terminal 2-5 minimum negative voltage	0.0%	-100.0% ~ 100.0%	---
			-400.0% ~ 400.0%	( 02-00(P.500)= 2/14/15/16/17 )
02-19 P.511	Percentage corresponds to terminal 2-5 maximum negative voltage	0.0%	-100.0% ~ 100.0%	---
			-400.0% ~ 400.0%	( 02-00(P.500)= 2/14/15/16/17 )

Setting

Terminal 2-5 signal selection, maximum operation frequency

- ◆ Set value of 02-09(P.38) is the target frequency value of inverter when terminal 2-5 input signal is 5V (10V).
- ◆ Example 1: This example is the most commonly used adjustment method. It is used when inverter is in "external mode", "combined mode 2" or "combined mode 4", and frequency command is given by terminal 2-5.

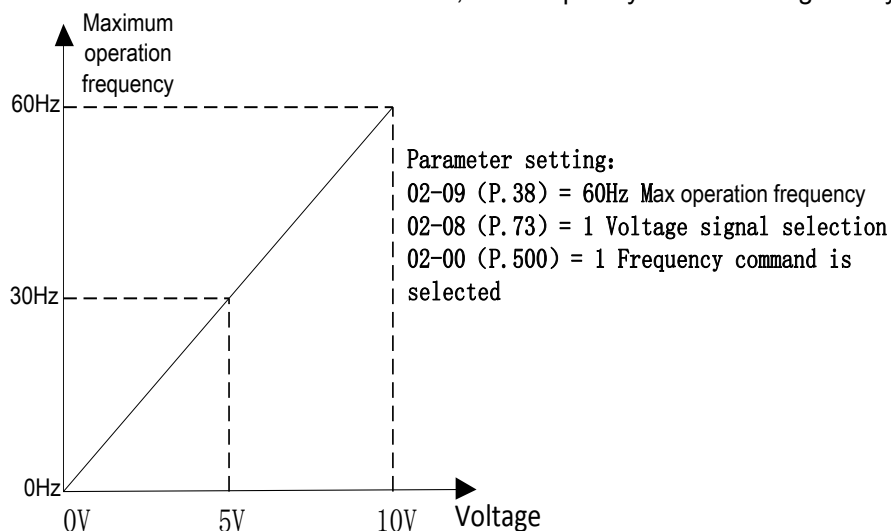



- ◆ Terminal 2-5 can be connected to a negative voltage, but 02-08(P.73) value needs to be changed. The frequency algorithm is same as positive voltage, and its running direction is unchanged.

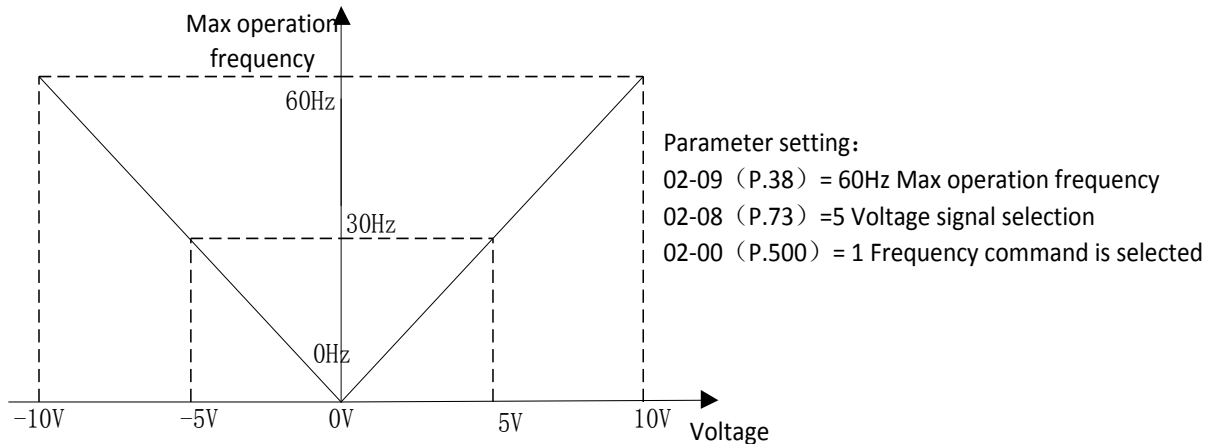

- Note: 1. In "External mode", "combined mode 2" or "combined mode 4", the inverter target frequency will be determined by signal between /2-5/4-5 terminal if RH, RM, RL and REX are all "off." (the default priority is 2-5>4-5>, please refer to 02-00(P.500)、02-01(P.501).
2. The functional names of RH, RM, RL, REX, AU, RT and RUN mentioned in this paragraph are "multi-function digital input terminals". For function of multi-function digital input terminal, please refer to 03-00~03-05(P.80~P.84、P.86) ; For more information on wiring, please refer to section 3.7 Terminal wire arrangement.
3. If use 02-08(P.73) to select 2-5 terminal voltage signal sampling range, it will affect the relevant value in section 5.3.5 parameter group of the 2-5 terminal input signal.

#### Setting Terminal 2-5 input signal processing

- ◆ Parameters above define the relationship between analog input voltage and set value in analog input. When analog input voltage exceeds maximum or minimum range of the set value, the excess part will be calculated as maximum and minimum input..
- ◆ There are two setting steps when setting maximum and minimum percentage:
  - 1) If users want to adjust the analog input to correspond with a certain type of proportional relationship, Adjust the analog input first and then set the corresponding proportional parameter. Inverter will calculate it by itself, don't need to set the voltage parameter (refer to Example 1.1).
  - 2) If users skip the adjustment of analog input and set proportional relationship directly, first set proportional parameter then set voltage parameters (refer to the example 1.2).

Example 1.1: User adjusts analog input voltage to minimum value A and sets parameter 02-14(P.194); adjusts input voltage to maximum value B, and sets parameter 02-15(P.195). As shown below:

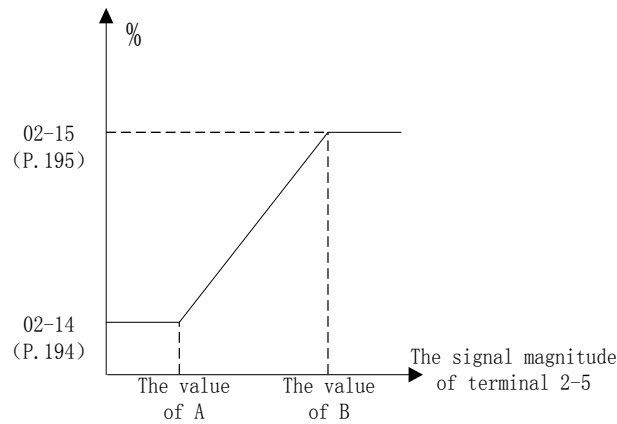

Example 1.2: Set 02-14(P.194) and 02-15(P.195) value, then set 02-12(P.192) and 02-13(P.193). Figure is shown as follows:

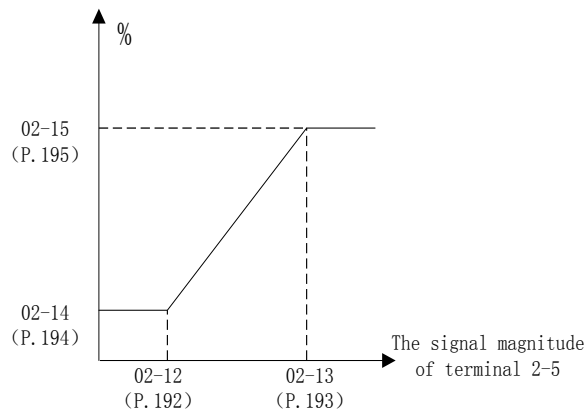

If the 02-00(P.500) function is selected as 1, 2-5 terminal analog input function is frequency command, the ratio calculated according to the above figure multiplied by 02-09(P.38) is the actual frequency input value (offset 02-11(P.139) = 0).

◆ Negative voltage setting is the same as positive voltage setting (as described above).

Example 2: This example is the most commonly used method. It is used when inverter is in “external mode”, “combined mode 2” or “combined mode 4”, and frequency command is given by terminal 2-5.

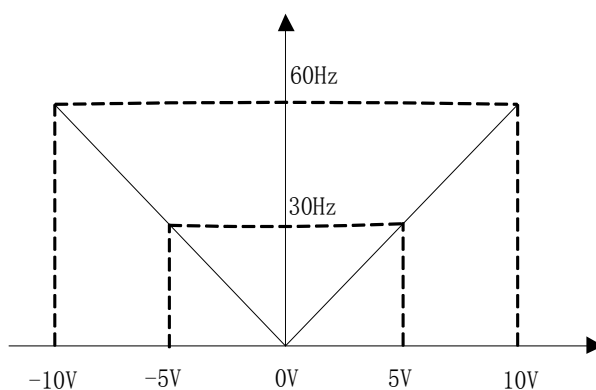

02-09(P.38)=60Hz Max operation frequency  
 02-12 ( P.192) =0V, 02-13 ( P.193) =10V The minimum/maximum input positive voltage of terminal 2-5  
 02-14 ( P.194) =0%, 02-15 ( P.195) =100% The setting corresponding to the minimum/maximum positive voltage of terminal 2-5  
 02-18 ( P.510) =0%, 02-19 ( P.511) =100% The setting corresponding to the minimum/maximum negative voltage of terminal 2-5  
 02-16 ( P.512) =0V, (02-17) P.513=10V The minimum/maximum input negative voltage of terminal 2-5  
 02-11 ( P.139) = 0% The bias rate of 2-5 voltage signal

Example 3: This example is for users who need the motor to run at 10Hz when the potentiometer is turned to the left end. All frequencies above 10Hz can still be adjusted by the user freely.

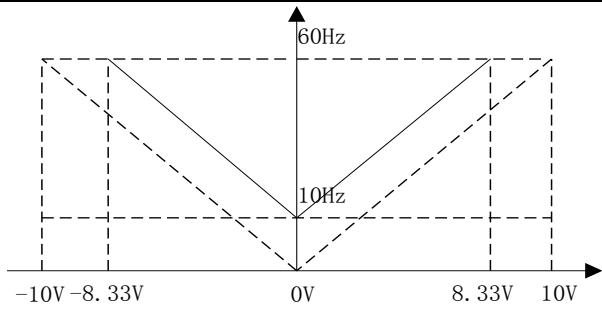

02-09 ( P.38 ) =60Hz Max operation frequency  
 02-12 ( P.192 ) =0V, 02-13 ( P.193 ) =8.33V The minimum/maximum input positive voltage of terminal 2-5  
 02-14 ( P.194 ) =16.7%, 02-15 ( P.195 ) =100% The setting corresponding to the minimum/maximum positive voltage of terminal 2-5  
 02-18(P.510) =16.7%, 02-19 ( P.511 ) =100% The setting corresponding to the minimum/maximum negative voltage of terminal 2-5  
 02-16 ( P.512 ) =0V, 02-17 ( P.513 ) =8.33V The minimum/maximum input negative voltage of terminal 2-5  
 02-14 ( P.194 ) = 02-18(P.510) = 10Hz / 60Hz \* 100  
 02-13 ( P.193 ) = 02-19 ( P.511 ) = 10V \* ( 100.0 - 02-14 ( P.194 ) ) / 100

Example 4: This example is also frequently used by the industry. The comprehensive usage for all domain of the potentiometer setup elevates the flexibility.

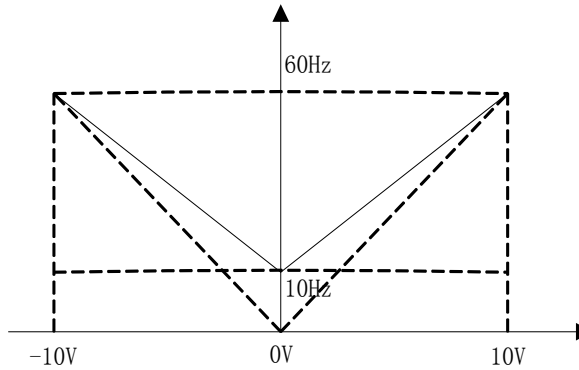

02-09 ( P.38 ) =60Hz Max operation frequency  
 02-12 ( P.192 ) =0V,02-13 ( P.193)=10V The minimum/maximum input positive voltage of terminal 2-5  
 02-14 ( P.194 ) =16.7%, 02-15(P.195)=100% The setting corresponding to the minimum/maximum positive voltage of terminal 2-5  
 02-18(P.510)=16.7%, 02-19(P.511)=100% The setting corresponding to the minimum/maximum negative voltage of terminal 2-5  
 02-16(P.512) =0V,02-17 ( P.513 ) =10V The minimum/maximum input negative voltage of terminal 2-5  
 02-11(P.139) = 0% The bias rate of 2-5 voltage signal  
 02-14 ( P.1940=02-15( P.510) = 10Hz / 60Hz \* 100

Example 5: This example uses 0~5V to give frequency command.

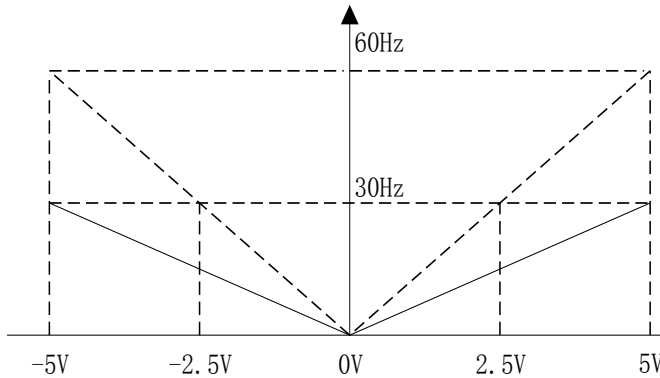

02-09 ( P.38 ) =60Hz Max operation frequency  
 02-12 ( P.1920=0V, 02-13(P.193)=5V The minimum/maximum input positive voltage of terminal 2-5  
 02-14(P.194)=0%, 02-15(P.195)=50% The setting corresponding to the minimum/maximum positive voltage of terminal 2-5  
 02-18(P.510) =0%, 02-19 ( P.511 ) =50% The setting corresponding to the minimum/maximum negative voltage of terminal 2-5  
 02-16(P.512) =0V,02-17(P.513)=5V The minimum/maximum input negative voltage of terminal 2-5  
 02-11(P.139) = 0% The bias rate of 2-5 voltage signal

Example 6: This example is used to avoid signal below 1V given to inverter as running frequency in harsh environment, which can greatly avoid the interference of noise.

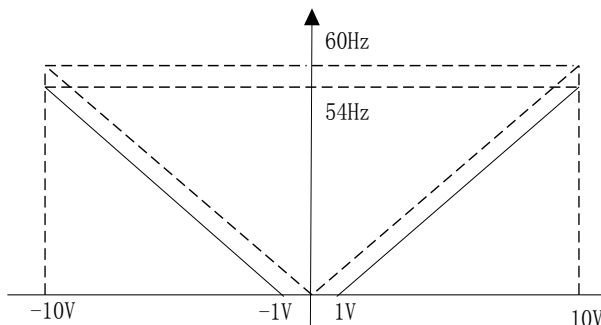

02-09 ( P.380=60Hz Max operation frequency  
 02-12(P.192)=1V, 02-13(P.193) =10V The minimum/maximum input positive voltage of terminal 2-5  
 02-14 ( P.194 ) =0%,02-15 ( P.1950=90% The setting corresponding to the minimum/maximum positive voltage of terminal 2-5  
 02-18(P.510) =0%,02-19 ( P.511 ) =90% The setting corresponding to the minimum/maximum negative voltage of terminal 2-5  
 02-16(P.512)=1V, 02-17(P.513)=10V The minimum/maximum input negative voltage of terminal 2-5  
 02-11(P.139) = 0% The bias rate of 2-5 voltage signal  
 02-15(P.195) = 02-19(P.511) = 100.0 - ( 1V / 10V ) \* 100

Example 7: This example is an extension of Example 6. This kind of application is open, user can apply flexibly.

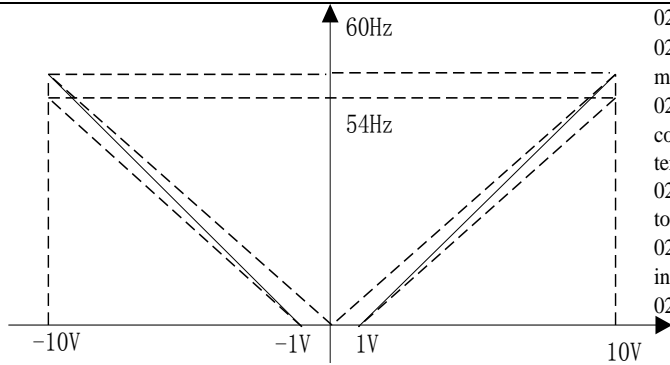

02-09 (P.38) =60Hz Max operation frequency  
 02-12 (P.192) =1V,02-13 (P.193) =10V The minimum/maximum input positive voltage of terminal 2-5  
 02-14 (P.194)=0%,02-15(P.195)=100% The setting corresponding to the minimum/maximum positive voltage of terminal 2-5  
 02-18(P.510)=0%,02-19(P.511)=100% The setting corresponding to the minimum/maximum negative voltage of terminal 2-5  
 02-16(P.512)=1V, 02-17(P.513) =10V The minimum/maximum input negative voltage of terminal 2-5  
 02-11(P.139) = 0% The bias rate of 2-5 voltage signal

Example 8: This example is an application of inverse slope setting. The industry often uses sensors for pressure, temperature or flow control. Some of the sensors output 10V signal at high voltage or high flow. This signal acts as a reference for the AC motor drive to decelerate or to stop. The setup presented in Example 8 can satisfy this type of application.

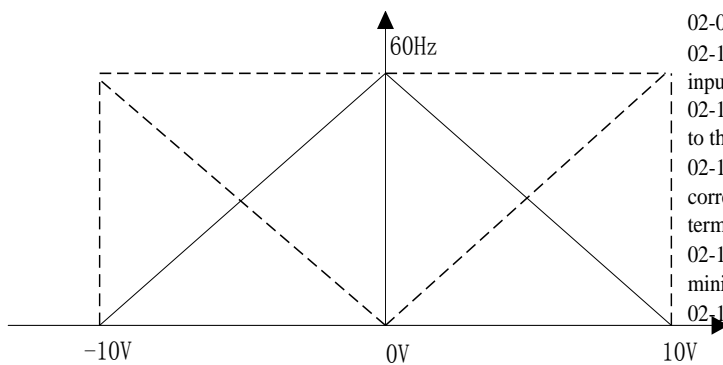

02-09 (P.38) =60Hz Max operation frequency  
 02-12 (P.192) =0V,02-13(P.193)=10V The minimum/maximum input positive voltage of terminal 2-5  
 02-14(P.194)=100%, 02-15(P.195)=0% The setting corresponding to the minimum/maximum positive voltage of terminal 2-5  
 02-18(P.510)=100%, 02-19 (P.511) =0% The setting corresponding to the minimum/maximum negative voltage of terminal 2-5  
 02-16 (P.512) =0V, 02-17 (P.513) =10V The minimum/maximum input negative voltage of terminal 2-5  
 02-11 (P.139) = 0% The bias rate of 2-5 voltage signal

Example 9: This example integrates all the application of potentiometer. Together with the application of forward and reverse rotation, it fits in the system easily for complicated application.

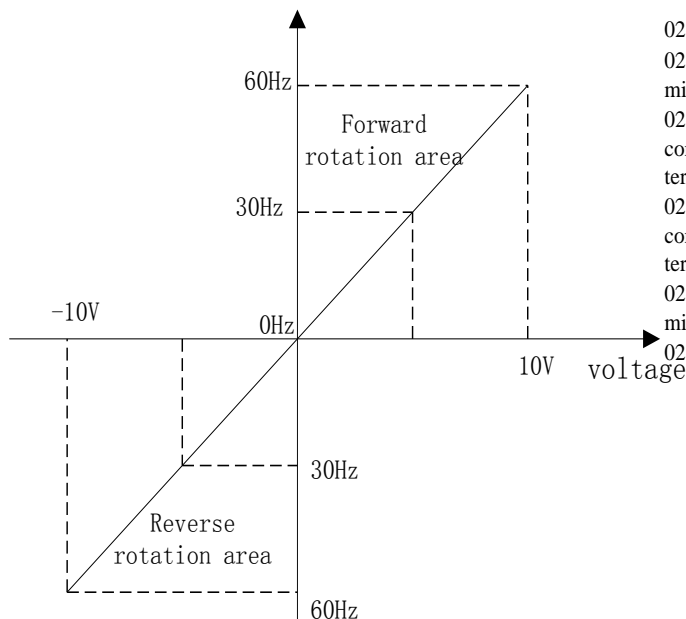

02-09 (P.38) =60Hz Max operation frequency  
 02-12 (P.192) =0V, 02-13 (P.193) =10V The minimum/maximum input positive voltage of terminal 2-5  
 02-14 (P.194) =0%, 02-15 (P.195) =100% The setting corresponding to the minimum/maximum positive voltage of terminal 2-5  
 02-18 (P.510) =0%, 02-19 (P.511) =-100% The setting corresponding to the minimum/maximum negative voltage of terminal 2-5  
 02-16 (P.512) =0V, 02-17 (P.513) =10V The minimum/maximum input negative voltage of terminal 2-5  
 02-11 (P.139) = 0% The bias rate of 2-5 voltage signal

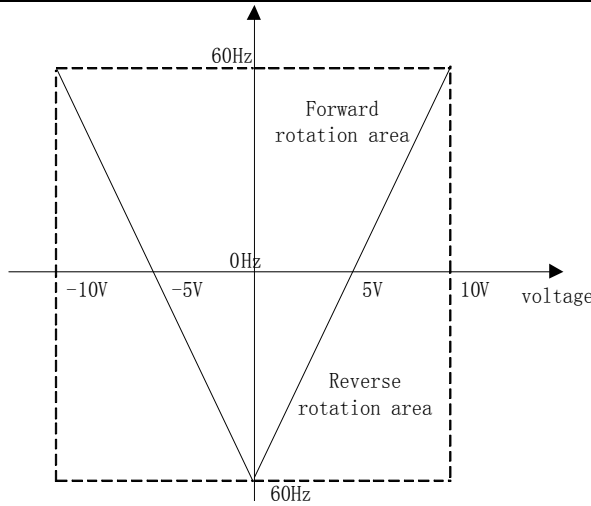

02-09 (P.38)=60Hz Max operation frequency  
 02-12(P.192)=0V, 02-13(P.193)=10V The minimum/maximum input positive voltage of terminal 2-5  
 02-14(P.194)=-100%,02-15(P.195)=100% The setting corresponding to the minimum/maximum positive voltage of terminal 2-5  
 02-18(P.510)=-100%, 02-19(P.511)=100% The setting corresponding to the minimum/maximum negative voltage of terminal 2-5  
 02-16(P.512)=0V,02-17(P.513)=10V The minimum/maximum input negative voltage of terminal 2-5  
 02-11(P.139) = 0% The bias rate of 2-5 voltage signal

Example 10: This example is the application with bias voltage. The bias voltage is set by 02-11. When 02-11=0%, there is no bias voltage; When 02-11>0%, there is the positive bias voltage; When 02-11<0%, there is the negative voltage.

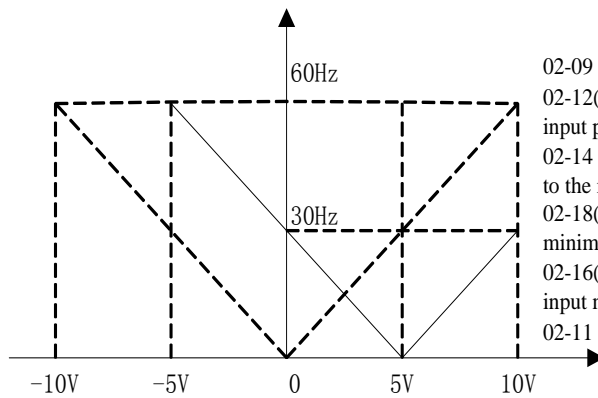

02-09 (P.38)=60Hz Max operation frequency  
 02-12(P.192) =0V, 02-13 (P.193) =10V The minimum/maximum input positive voltage of terminal 2-5  
 02-14 (P.194) =0%, 02-15 (P.195) =100% The setting corresponding to the minimum/maximum positive voltage of terminal 2-5  
 02-18(P.510)=0%, 02-19(P.511)=100% The setting corresponding to the minimum/maximum negative voltage of terminal 2-5  
 02-16(P.512) =0V, 02-17 (P.513) =10V The minimum/maximum input negative voltage of terminal 2-5  
 02-11 (P.139) = 50% The bias rate of 2-5 voltage signal

Note: 1. Above is only an example of 02-00 = 1. and the same applies when 02-00 is another non-zero value. For details, refer to the description of 02-00.  
 2. If use 02-08 to select 2-5 terminal voltage signal sampling range, it will affect the relevant value in section 5.3.5 parameter group of the 2-5 terminal input signal..

### 5.3.6 Terminal 4-5 signal selection and processing

➤ Choose terminal 4-5 signal specifications, frequency compensation function, and signal polarity .etc.

Parameter	Name	Default	Setting Range	Content
02-20 P.17	Terminal 4-5 signal range selection	0	0	Signal sampling range from 4~20mA.
			1	Signal sampling range from 0 ~ 10V.
			2	Signal sampling range from 0 ~ 5V.
02-21 P.39	Terminal 4-5 maximum operation frequency	50.00Hz	1.00 ~ 650.00Hz	50Hz system (00-24(P.189)=1)
		60.00Hz		60Hz system (00-24(P.189)=0)
02-22 P.528	Terminal 4-5 filter time	30ms	0 ~ 2000ms	---
02-23 P.505	Terminal 4-5 current/ voltage signal bias rate	0.0%	-100.0% ~ 100.0%	---

## Analog input and output parameter group 02

Parameter	Name	Default	Setting Range	Content
02-24 P.184	Terminal 4-5 disconnect selection	0	0	Off
			1	Inverter decelerates to 0Hz, multi-function digital output terminal set off alarm
			2	Inverter stops immediately, and keypad displays "AEr" alarm
			3	Inverter runs continuously according to the frequency reference before disconnection. Digital output terminal will set off alarm.
02-25 P.198	Terminal 4-5 minimum input current/ voltage	4.00mA	0 ~ 20.00mA	---
02-26 P.199	Terminal 4-5 maximum input current/ voltage	20.00mA	0 ~ 20.00mA	---
02-27 P.196	Percentage corresponds to terminal 4-5 minimum input current/ voltage	0.0%	-100.0% ~ 100.0%	---
			-400.0% ~ 400.0%	( 02-01(P.501)= 2/14/15/16/17 )
02-28 P.197	Percentage corresponds to terminal 4-5 maximum input current/ voltage	100.0%	-100.0% ~ 100.0%	---
			-400.0% ~ 400.0%	( 02-01(P.501)= 2/14/15/16/17 )

### Setting Terminal 4-5 selection and processing

#### ◆ Terminal 4-5 signal selection and the maximum operation frequency

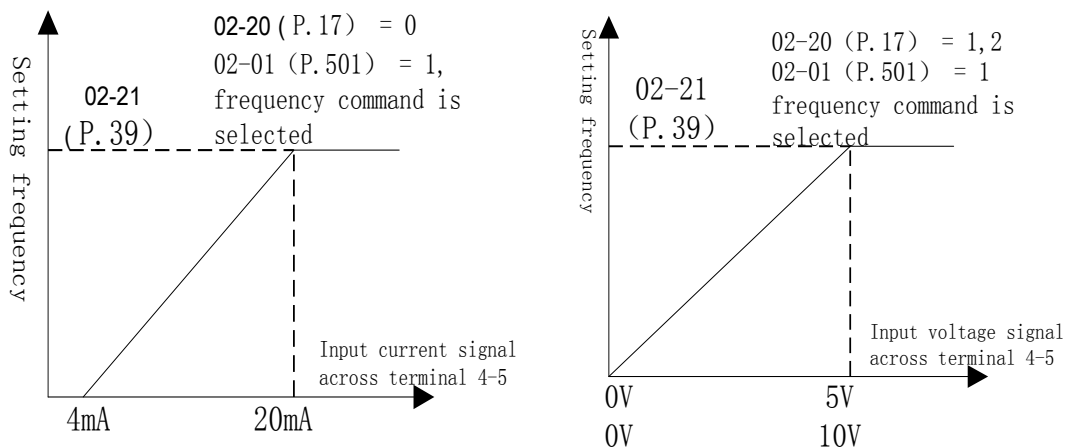

Note:1. In "external mode" or "mixed mode 2" or "mixed mode 4", if AU is "on" and 02-01(P.501)=1, target frequency of inverter is determined by the signal of terminal 4-5; and if AU is "off", please refer to 02-00(P.500), 02-01(P.501).

2. In "external mode" or "mixed mode 2" or "mixed mode 4", If AU and any one of RH, RM, RL or REX are "on" at the same time, multi-speed will have the priority to target frequency.

3. RH, RM, RL, REX, AU mentioned in this paragraph are the functional names of "terminals for multi-function digital input". Please refer to 03-00~03-05(P.80~P.84, P.86) for function selection and usage of multi-function digital input terminals. Please refer to section 3.7 Terminal wire arrangement.

◆ Terminal 4-5 disconnect function

- 1) If 02-24(P.184)=0, after disconnection, inverter will slow down to 0Hz, and after reconnection, the inverter will accelerate to current given frequency.
- 2) If 02-24(P.184)=1, after disconnection, inverter will slow down to 0Hz and at the same time multi-function digital output terminal will set off an alarm; after reconnection, alarm will be released and the inverter will accelerate to the current given frequency.
- 3) If 02-24(P.184)=2, after disconnection, the keypad will display “AEr” alarm, inverter will stop immediately, and reset is required to release the alarm..
- 4) If 02-24(P.184) = 3, after disconnection, the inverter will continue to run according to the frequency command before disconnection, the multi-function digital output terminal will set off an alarm, which will be released after reconnection.

Note: 1. Terminal 4-5 disconnection function is only for current disconnection. Please check the setting of parameter 02-20 (P.17) and the position of SW3.

2. Please refer to 03-10(P.40) ,03-11(P.85) for functional selection of multi-function digital output terminals; and refer to section 3.7 Terminal wire arrangement.

◆ Terminal 4-5 current/voltage input

Terminal 4-5 input current/voltage setting is similar to terminal 2-5. They share same setting except terminal 4-5 doesn't allow negative voltage and the minimum input current is 4mA.

Note: Functions mentioned above requires flipping the switch SW3 and setting 02-20 (P. 17)

### 5.3.7 Terminal HDI signal selection and processing

- The selection and processing of HDI input are only applicable to digital input M2 terminal, and other digital input terminals cannot be set as HDI functions

Parameter	Name	Default	Setting Range	Content
02-38 P.526	Terminal HDI filter time	10ms	0 ~ 2000ms	---
02-39 P.524	Terminal HDI minimum input frequency	0.00kHz	0 ~ 100.00kHz	---
02-40 P.525	Terminal HDI maximum input frequency	100.00 kHz	0 ~ 100.00kHz	---
02-41 P.522	Percentage corresponds to terminal HDI minimum input frequency	0.0%	-100.0% ~ 100.0%	---
			-400.0% ~ 400.0%	( 02-03(P.503)= 2/14/15/16/17 )
02-42 P.523	Percentage corresponds to terminal HDI maximum input frequency	100.0%	-100.0% ~ 100.0%	---
			-400.0% ~ 400.0%	( 02-03(P.503)= 2/14/15/16/17 )

**Setting** Terminal HDI selection and processing

- ◆ “HDI filter time” 02-38(P.526) is used to filter out the vibration of operation frequency caused by factors such as component precision or noise. The larger the set value of 02-38(P.526), the better the filtering ability, but in the meantime it will also cause response to be slower
- ◆ HDI is sharing terminal with M2, set parameter 03-05(P.82) to 41、54、57 as HDI function.

Note: The frequency computing method of HDI input signal is similar to 2-5 analog input, the formula is  $01-00(P.1) * ((\text{the input frequency} - 02-39(P.524)) * (02-42(P.523) - 02-41(P.522)) / (02-40(P.525) - 02-39(P.524)) + 02-41(P.522))$

### 5.3.8 Terminal HDO clock multiplier factor

➤ This parameter is used to set the output square-wave characteristic of output terminal HDO.

Parameter	Name	Default	Setting Range	Content
02-43 P.74	Terminal HDO clock multiplier factor	0	0	Select FM function as the output function of terminal HDO.
			1 ~ 9000	factor for square-wave pulse output frequency. Value in 02-43 (P.74) times output frequency will be actual output pulse frequency.

**Setting** Terminal HDO clock multiplier factor

- ◆ When the setting value of 02-43(P.74) is 1~9000, the external terminal “HDO” is a frequency multiplication output function, with a maximum output frequency of 100kHz
- ◆ When 02-43(P.74) is set at 5 and the instantaneous frequency of operation is 20Hz, the output pulse wave between terminal HDO and terminal SD is as following diagram:

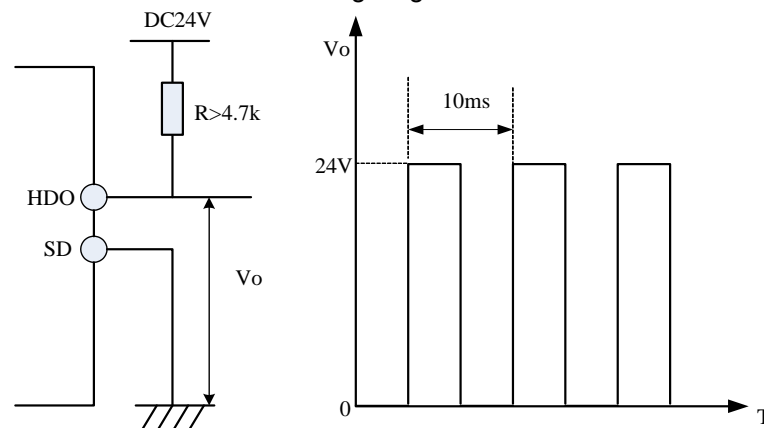

Note: When 02-43(P.74)=1, the output is one time of the running frequency. And the inverter can provide the output from 1~650Hz which precision is 1%. The bigger the value of 02-43(P.74) and the bigger the running frequency is, the worse the precision will be.



### 5.3.9 Terminal FM analog output function selection

➤ Selects monitor item output by terminal FM, when terminal HDO output function is FM.

Parameter	Name	Default	Setting Range	Content
02-44 P.543	Terminal FM output function selection	0	0	Output frequency, use 02-51 (P.55) value as 100%.
			1	Output current, use 02-52 (P.56) value as 100%.
			2	Output DC bus voltage, use the OV trigger voltage as 100%.
			3	Output inverter temperature accumulate rising rate, use NTC trigger level as 100%.
			4	Output inverter thermal relay accumulate rate, use the digital thermal relay trigger level ( 06-00 ( P.9 ) ≠ 0 ) or the thermal relay on IGBT trigger level ( 06-00 (P.9) = 0) as 100%.
			5	Target frequency, use 02-51(P.55) value as 100%.
			6	Fixed output, voltage or current output level can be set by 02-54 (P.541)
			7	Output voltage, use inverter rated voltage as 100%
			8	Excitation current, use motor rated current as 100%. (Valid only when 00-21(P.300) or 00-22 (P.370) is set to 3~6)
			9	Output torque, use two times motor rated torque as 100%. (Valid only when 00-21 (P.300) or 00-22 (P.370) is set to 3~6)
			10	Output power, use two times motor rated power as 100%.
			11	High-speed pulse input, use 100KHz as 100%.
12	Motor speed, use 02-51 (P.55) as 100%			

Setting Usage of analog output terminal FM

◆ For the calibration of terminal FM, please refer to 5.3.14 FM calibration parameter.

### 5.3.10 Terminal AM signal selection and processing

➤ Adjust terminal AM analog output type and level.

Parameter	Name	Default	Setting Range	Content
02-45 P.64	Terminal AM output signal selection	0	0	Output 0~10V across terminal AM-5.
			1	Reserved
			2	Output 0~20mA across AM-5.
			3	Output 4~20mA across AM-5.
02-46 P.191	AM output gain	935	0 ~ 1024	---
02-47 P.190	AM output bias	0	0 ~ 1024	---

Setting Terminal AM signal selection and processing

◆ Terminal AM output current/voltage is set by toggle switch SW2 on the control board with parameter 02-45(P.64). When selecting the output type of AM terminal, first dial toggle switch SW2 to correspond position, then set 02-45(P.64) value.

- ◆ Terminal AM output can be shown as follows::

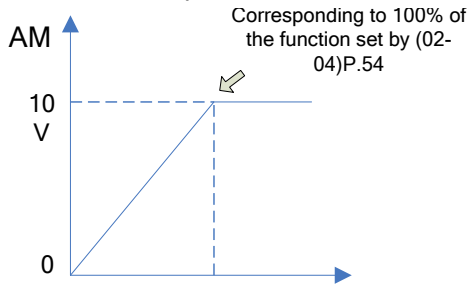

Figure 1. AM-5 output 0~10V voltage

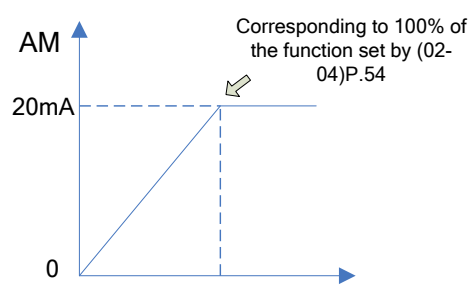

Figure 2. AM-5 output 0~20mA current

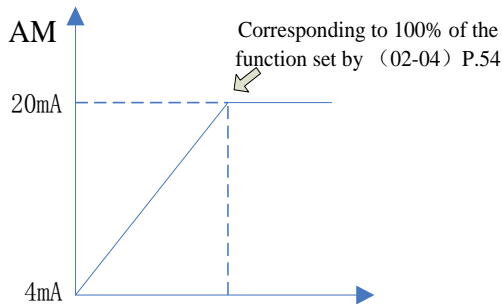





Figure 3. AM-5 output 4~20mA current

- ◆ Terminal AM needs to be calibrated due to differences in components, voltage/current calibration includes the following steps:

1. Set the toggle switch SW2 to 0~10V/0~20mA, then set 02-45(P.64) to 0 or 2.
2. Link an electric meter with full scale 10V/20mA across terminal AM and terminal 5, then set 02-04(P.54) to 0, 02-51(P.55) to 60Hz.
3. Set 01-11(P.13) to 0 and start the motor. Set output frequency to 0 Hz.
4. Turn  to adjust the value of 02-47(P.190). Display shows the AM accumulated output bias voltage. Press  for more than 1 second, and the pointer will move upward. Turn  to reduce the value of 02-47(P.190), display shows decreased output bias voltage of AM. Press  for more than 1 second, and the pointer will move downward. When the pointer is adjusted to 0, the calibration of AM output bias voltage is completed.
5. Set output frequency to 60 Hz.
6. Read the value of 02-46(P.191), and display will show the current AM output gain.
7. Turn  to adjust the value of 02-46(P.191). Press  for more than 1 second, and the pointer will move upward or downward. When the pointer moves to the full-scale position, the calibration is completed.

Note: When selecting the output signal of terminal AM, please pay attention to the switch of SW2. If 4~20mA output current is selected, please switch SW2 to 0~20mA.

### 5.3.11 Maximum analog output reference

- Set display reference for terminal AM/FM when output frequency or current.

Parameter	Name	Default	Setting Range	Content
02-51 P.55	Maximum analog output frequency reference	50.00Hz	1 ~ 650.00Hz	50Hz system(when 00-24(P.189)=1)
		60.00Hz		60Hz system(when 00-24(P.189)=0)
02-52 P.56	Maximum analog output current reference	Note	0 ~ 500.00A	Frame D and the types below

#### Setting Maximum output reference

- ◆ Terminal AM/FM analog output uses 02-51(P.55) as 100% for frequency reference.
- ◆ Terminal AM/FM analog output uses 02-52(P.56) as 100% for current reference.

Note: Default value for 02-52(P.56) is determined by kW.

### 5.3.12 Terminal AM/FM fixed output level

- Makes AM/FM output a fixed level signal.

Parameter	Name	Default	Setting Range	Content
02-54 P.541	Terminal AM/FM fixed output level	0.0%	0 ~ 100.0%	---

#### Setting

- ◆ Set 02-54(P.541) to 0~100.0%, which corresponds to 0~10V/20mA of AM;

For example: 02-54(P.541) =50%, the output of AM is  $10V \times 50\% = 5V$ .

### 5.3.13 PT100 level setting

- Sets PT100 protection level and operation frequency

Parameter	Name	Default	Setting Range	Content	
02-55 P.592	PT100 thermistor voltage level 1	5.00V	0 ~ 10.00V	0	Off
				0.10V~10.00V	If PT100 voltage is higher than level 1, output frequency will decrease to 02-57 (P.594) after 02-58 (P.595) setting time.
02-56 P.593	PT100 thermistor voltage level 2	7.00V	0 ~ 10.00V	0	Off
				0.10V~10.00V	If PT100 voltage is higher than level 2, act correspondingly according to the settings of 06-15 (P.533).
02-57 P.594	PT100 thermistor level 1 frequency	0.00Hz	0 ~ 650.00Hz	When PT100 voltage is higher than level 1, output frequency will decrease to 02-57 (P.594)	
02-58 P.595	PT100 thermistor level 1 delay time	60s	0 ~ 6000s	Action delay time when output frequency decreases to 02-57 (P.594)	

## Analog input and output parameter group 02

### Setting PT100 level setting

- ◆ PT100 is input through analog voltage, and the voltage input range of 2-5/4-5 is set to 0-10V (02-08(P.73)=1; 02-20(P.17)=1; please note that the voltage/current switch on the keypad is set to the voltage input position). Set analog voltage input for PT100 function (02-00(P.500),02-01(P.501) are set to 12).
- ◆ When the inverter is running and PT100 input voltage is higher than 02-55(P.592) value, inverter output frequency will decrease to 02-57(P.594) set frequency after 02-58(P.595) set time.
- ◆ When PT100 voltage is higher than 02-56(P.593), inverter will operate according to the settings of 06-15 (P.533).

### 5.3.14 FM calibration parameter

➤ It is used to adjust the analog voltage level that terminal FM outputs.



Parameter	Name	Default	Setting Range	Content
02-59 P.187	FM calibration parameter	450	0 ~ 9998	---

### Setting FM calibration parameter

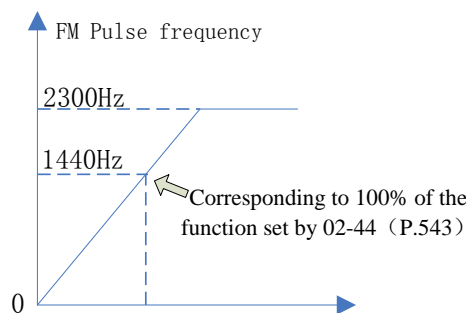
- ◆ Output of terminal HDO with FM function can be shown as follows:



Terminal HDO needs to be calibrated due to differences in components, voltage/current calibration includes the following steps:

1. Link an electric meter with 1mA scale or a high speed counter across terminal HDO and terminal SD. Wire as following figure , and set 02-51(P.55) to 60Hz,02-44(P.543) to 0.
2. Start the motor and set output frequency 60Hz.
3. When the motor runs steadily, read out 02-59(P.187) value. Display will show FM calibration value. Turn  to increase and adjust 02-59(P.187) value. Press  for more than 1 second, and the pointer will move upward. Turn  to decrease and adjust 02-59(P.187) value. Press  for more than 1 second and the pointer on the meter will move downward.

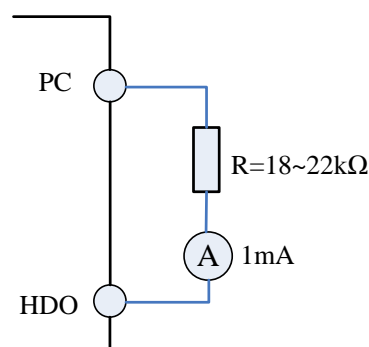

## 5.4 Digital input/ output parameter group 03

Group	Parameter Number	Name	Setting Range	Default	Page
03-00	P.83	Terminal STF input function	0: STF(Inverter runs forward)	0	119
			1: STR(Inverter runs reverse)		
			2: RL(Multi-speed low speed)		
			3: RM(Multi-speed medium speed)		
			4: RH(Multi-speed high speed)		
			5:AU( Analog terminal 4-5 high priority)		
			6: External thermal relay actuate		
			7: MRS(Stops inverter output immediately)		
			8: RT(Inverter second function)		
			9: EXT(External JOG)		
			10: STF+EXJ		
			11: STR+EXJ		
			12: STF+RT		
			13: STR+RT		
			14: STF+RL		
			15: STR+RL		
			16: STF+RM		
			17: STR+RM		
			18: STF+RH		
			19: STR+RH		
			20: STF+RL+RM		
			21: STR+RL+RM		
			22: STF+RT+RL		
			23: STR+RT+RL		
			24: STF+RT+RM		
			25: STR+RT+RM		
			26: STF+RT+RL+RM		
			27: STR+RT+RL+RM		
			28: RUN(Inverter runs forward)		
			29: STF/STR(use with RUN signal, when ON, motor runs reverse ; when OFF, motor runs forward)		
			30: RES(External reset function)		
			31: STOP(Use as three line control with RUN signal and STF-STR signal)		
			32: REX(Extend multi-speed to 16 levels)		
			33: PO(In "external mode", run programmed operation)		
34: RES_E (External reset, valid only when alarm.)					

Digital input/ output parameter group 03

Group	Parameter Number	Name	Setting Range	Default	Page
03-00	P.83	Terminal STF input function	35: MPO (In "external mode" run manual cycle operation.)	0	<u>119</u>
			36: TRI(Triangle wave function)		
			37: GP_BP (Automatic switch between inverter and commercial power-supply.)		
			38: CS(Manual switch to commercial power supply)		
			39: STF/STR +STOP (Use with RUN signal, when ON, motor runs reverse, when OFF, motor stops then runs forward.)		
			40: P_MRS (Stops inverter output immediately by pulse signal input)		
			41: PWM set frequency(Note 1)		
			42: MTCLKA/MTCLKB(only for M0/M1)		
			43: RUN_EN (Enable digital input terminal operation)		
			44: PID_OFF (Enable digital input terminal turning off PID)		
			45: Second mode		
			46: Initial roll radius selection 1		
			47: Initial roll radius selection 2		
			48: Thickness selection 1		
			49: Thickness selection 2		
			50: Winding unwinding switch		
			51: Predrive command		
			52: Save torque value		
			53: Save torque value enable		
			54: Revs counting signal (note1)		
			55: Speed/Torque control switch		
			56: Roll radius reset		
			57: High-speed pulse input function (note1)		
			58: Analog terminal 2-5 high priority		
			60: Built-in PLC start/stop		
			61: SHOM (Homing enable)		
			62: ORGP (Set homing point)		
			63: Position/Speed control switch		
			64: External zero-servo switch		
			65: External accelerate/decelerate pause		
66: External forced stop					
67 : Roll diameter calculation stop					
68 : Enable single point positioning					
69 : Enable multipoint positioning					
70 : Enable entire position control by pulse input command					
71 : External torque command polarity reverse					
99999 : Off					
03-01	P.84	Terminal STR input function	Same as 03-00(P.83)	1	<u>120</u>
03-02	P.86	Terminal RES input function	Same as 03-00(P.83)	30	<u>120</u>
03-03	P.80	Terminal M0 input function	Same as 03-00(P.83)	2	<u>121</u>
03-04	P.81	Terminal M1 input function	Same as 03-00(P.83)	3	<u>121</u>
03-05	P.82	Terminal M2 input function	Same as 03-00(P.83)	4	<u>121</u>

Group	Parameter Number	Name	Setting Range	Default	Page
03-10	P.40	Terminal SO-SE output function	0: RUN(Output when inverter running)	1	<u>126</u>
			1: SU(Output when reach target frequency)		
			2: FU(Output when reach 03-21 03-22 value )		
			3: OL(Output when overload)		
			4: OMD(Output when output current is zero)		
			5: ALARM(Output when alarm)		
			6: PO1(Output when in program operation step)		
			7: PO2(Output when in program operation cycle)		
			8:PO3(Output when in program operation pause)		
			9: BP(Output when use inverter output in function : switch between inverter and commercial power-supply)		
			10: GP(Output when use commercial power-supply in function : switch between inverter and commercial power-supply)		
			11 : OMD1(Output when output current is zero 1)		
			12 ~ 16: Reserved		
			17: RY(Output when inverter is powered on and no alarm)		
			18: Output when it's time for maintenance		
			19: OL2 (Output when overload 2)		
			20: Output when capacitor abnormal		
21:Output when in position control reach position					
22 : Output when detect curl in tension control					
23 : Output when detect power marker					
24 ~ 40: Reserved					
41: Feedback disconnection alarm					
03-11	P.85	Terminal A-B-C output function	Same as 03-10(P.40)	5	<u>126</u>
03-14	P.87	Digital input logic	0 ~ 1023	0	<u>127</u>
03-15	P.88	Digital output logic (with expansion card)	0 ~ 4095	0	<u>127</u>
03-16	P.120	Output signal delay time	0 ~ 3600.0s	0.0s	<u>128</u>
03-17	P.157	Digital input terminal filter time	0 ~ 2000ms	8ms	<u>128</u>
03-18	P.158	Digital input terminal enable when power on	0: When power on digital terminals work directly	0	<u>128</u>
			1:When power on digital terminals work after switch off then on		
03-20	P.41	Output frequency detection sensitivity	0 ~ 100.0%	10.0%	<u>129</u>
03-21	P.42	Output frequency detection for forward rotation	0 ~ 650.00Hz	6.00Hz	<u>129</u>
03-22	P.43	Output frequency detection for reverse rotation	0 ~ 650.00Hz	99999	<u>129</u>
			99999: Same as the setting of 03-21(P.42)		
03-23	P.62	Zero current detection level	0 ~ 200.0%	5.0%	<u>130</u>
			99999: Off		

Digital input/ output parameter group 03

Group	Parameter Number	Name	Setting Range	Default	Page
03-24	P.63	Zero current detection time	0 ~ 100.00s	0.50s	<a href="#">130</a>
			99999: Off		
03-25	P.551	Expanded digital input terminal M10	Same as 03-00(P.83)	99999	<a href="#">130</a>
03-26	P.552	Expanded digital input terminal M11	Same as 03-00(P.83)	99999	<a href="#">130</a>
03-27	P.553	Expanded digital input terminal M12	Same as 03-00(P.83)	99999	<a href="#">130</a>
03-28	P.554	Expanded digital input terminal M13	Same as 03-00(P.83)	99999	<a href="#">129</a>
03-29	P.555	Expanded digital input terminal M14	Same as 03-00(P.83)	99999	<a href="#">130</a>
03-30	P.556	Expanded digital input terminal M15	Same as 03-00(P.83)	99999	<a href="#">130</a>
03-41	P.567	Expanded digital input terminal logic (Slot2&3)	0 ~ 63	0	<a href="#">131</a>
03-42	P.568	Expanded digital output terminal A10	Same as 03-10(P.40)	99999	<a href="#">131</a>
03-43	P.569	Expanded digital output terminal A11	Same as 03-10(P.40)	99999	<a href="#">131</a>
03-44	P.570	Expanded digital output terminal A12	Same as 03-10(P.40)	99999	<a href="#">131</a>
03-45	P.571	Expanded digital output terminal A13	Same as 03-10(P.40)	99999	<a href="#">131</a>
03-46	P.572	Expanded digital output terminal A14	Same as 03-10(P.40)	99999	<a href="#">131</a>
03-47	P.573	Expanded digital output terminal A15	Same as 03-10(P.40)	99999	<a href="#">131</a>
03-48	P.574	Expanded digital output terminal A16	Same as 03-10(P.40)	99999	<a href="#">131</a>
03-49	P.575	Expanded digital output terminal A17	Same as 03-10(P.40)	99999	<a href="#">131</a>
03-59	P.585	Monitor inverter digital input terminal state	Read only	Read	<a href="#">132</a>
03-60	P.586	Monitor inverter and expanded digital output terminal state	Read only	Read	<a href="#">132</a>
03-61	P.587	Monitor expanded digital input terminal state	Read only	Read	<a href="#">132</a>



## 5.4.1 Digital input terminals function selection

- Use the following parameters to change the digital input terminal functions. Each terminal may choose any function between 0~71 (Note 1)

Parameter	Name	Default	Setting Range	Content
03-00 P.83	Terminal STF input function	0	0	STF(Inverter runs forward)
			1	STR(Inverter runs reverse)
			2	RL(Multi-speed low speed)
			3	RM(Multi-speed medium speed)
			4	RH(Multi-speed high speed)
			5	AU( Analog terminal 4-5 high priority)
			6	OH External thermal relay actuate
			7	MRS(Stops inverter output immediately)
			8	RT(Inverter second function)
			9	EXT(External JOG)
			10	STF+EXJ
			11	STR+EXJ
			12	STF+RT
			13	STR+RT
			14	STF+RL
			15	STR+RL
			16	STF+RM
			17	STR+RM
			18	STF+RH
			19	STR+RH
			20	STF+RL+RM
			21	STR+RL+RM
			22	STF+RT+RL
			23	STR+RT+RL
			24	STF+RT+RM
			25	STR+RT+RM
			26	STF+RT+RL+RM
			27	STR+RT+RL+RM
			28	RUN(Inverter runs forward)
			29	STF/STR(use with RUN signal,when ON, motor runs reverse ; when OFF, motor runs forward)
			30	RES(External reset function)
			31	STOP(Use as three line control with RUN signal and STF -STR signal)
			32	REX(Extend multi-speed to 16 levels)
33	PO(In "external mode", run programmed operation)			

Digital input/ output parameter group 03

Parameter	Name	Default	Setting Range	Content
03-00 P.83	Terminal STF input function	0	34	RES_E (External reset, valid only when alarm.)
			35	MPO (In "external mode" run manual cycle operation.)
			36	TRI(Triangle wave function)
			37	GP_BP (Automatic switch between inverter and commercial power-supply.)
			38	CS(Manual switch to commercial power supply)
			39	STF/STR +STOP (Use with RUN signal, when ON, motor runs reverse,when OFF, motor stops then runs forward.)
			40	P_MRS (Stops inverter output immediately by pulse signal input)
			41	PWM set frequency(Note 1)
			42	MTCLKA/MTCLKB(only for M0/M1)
			43	RUN_EN (Enable digital input terminal operation)
			44	PID_OFF (Enable digital input terminal turning off PID)
			45	Second mode
			46	Initial roll radius selection 1
			47	Initial roll radius selection 2
			48	Thickness selection 1
			49	Thickness selection 2
			50	Winding unwinding switch
			51	Predrive command
			52	Save torque value
			53	Save torque value enable
			54	Revs counting signal (note1)
			55	Speed/Torque control switch
			56	Roll radius reset
			57	High-speed pulse input function (note1)
			58	Analog terminal 2-5 high priority
			59	Reserved
			60	Built-in PLC start/stop
			61	SHOM (Homing enable)
			62	ORGP (Set homing point)
			63	Position/Speed control switch
			64	External zero-servo switch
65	External accelerate/decelerate pause			
66	External forced stop			
67	Roll diameter calculation stop			
68	Enable single point positioning			
69	Enable multipoint positioning			
70	Enable entire position control by pulse input command			
71	External torque command polarity reverse			
			99999	Off
03-01 P.84	Terminal STR input function	1	Same as 03-00	Same as 03-00(P.83)
03-02 P.86	Terminal RES input function	30	Same as 03-00	Same as 03-00(P.83)

Parameter	Name	Default	Setting Range	Content
03-03 P.80	Terminal M0 input function	2	Same as 03-00	Same as 03-00(P.83)
03-04 P.81	Terminal M1 input function	3	Same as 03-00	Same as 03-00(P.83)
03-05 P.82	Terminal M2 input function	4	Same as 03-00	Same as 03-00(P.83)

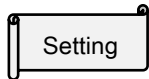

Digital input terminals function selection

- ◆ At default, 03-03(P.80)=2(RL), 03-04(P.81)=3(RM), 03-05(P.82)=4(RH), 03-00(P.83)=0(STF), 03-01(P.84)=1(STR), 03-02(P.86)=30(RES).
- ◆ Changing 03-01(P.84)~03-03(P.80) settings change the function of the terminals. For example, 03-03(P.80)=2 means that M0 terminal acts as RL. If 03-03(P.80) is set to 8, M0 terminal function will change to RT, which will act as “second function”. Another example, 03-00(P.83)=0 means that STF terminal serves as “inverter runs forward” function, and if change 03-00(P.83) to 6, STF terminal function will change to OH, which will serve as the input terminal of external thermal relay..
- ◆ Set value:5 AU(Analog terminal 4-5 high priority)  
When this terminal is ON, frequency command source priority will force to 4-5. (If the frequency commands are given to 4-5, 2-5 at the same time, the priority will become 4-5 > 2-5 when this terminal is on).
- ◆ Set value:6 OH(External thermal relay):  
Old motors usually come with thermal relay attached to the front of the motor to prevent motor from overheating. When external thermal relay actuate, inverter will alarm and show “OHT”.
- ◆ Four different wiring techniques (1 means ON, 0 means Off, and X = 0, 1, 2, 3, 4, 6)..

1) Two-wire control mode 1:

K0	K1	Operating Instructions
0	0	Stop
1	0	Run Forward
0	1	Run Reverse
1	1	Stop

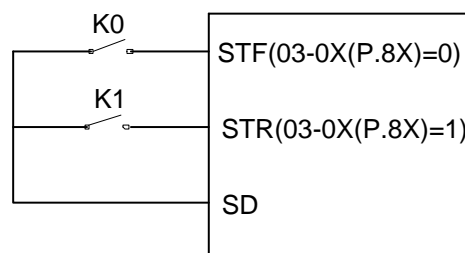

2) Two-wire control mode 2:

K0	K1	Operating Instructions
0	0	Stop
0	1	Stop
1	0	Run Forward
1	1	Run Reverse

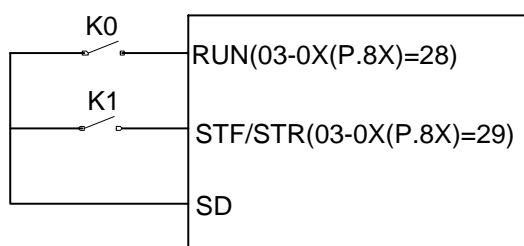

- 3) Three-wire control mode 1 (with seal-in function): K0 is STOP, normal close. When trigger inverter will stop. K1 is forward and K2 is reverse, normal open. All K0 K1 K2 are edge trigger button.

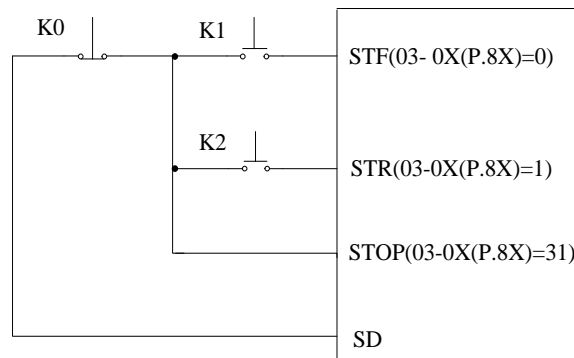

- ◆ Three-wire control mode 2 (with seal-in function): K1 is STOP, normal close. When trigger inverter will stop. K2 is RUN, normal open. K1 K2 are edge trigger buttons. Change direction by STF/STR terminal, set value: 39. When changing the direction, stop the inverter first, then switch K0 state and start inverter again.

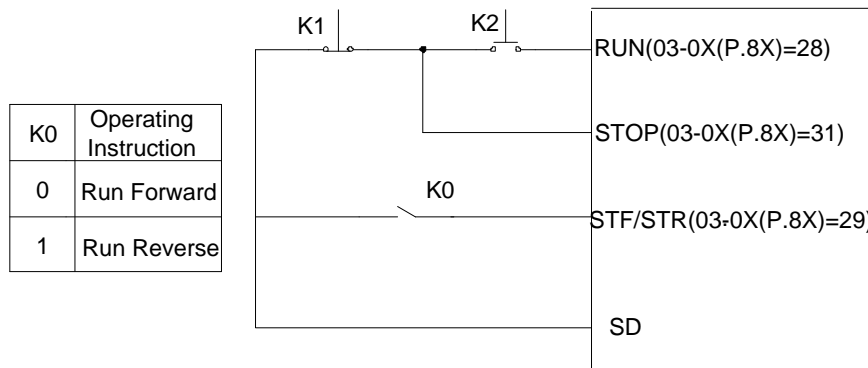

- ◆ Set value: 33 PO(programmed operation):

When in external mode and PO is ON, inverter will be in programmed operation mode. Terminal STF is start. When STF is ON, inverter run programmed operation mode at the first section. When STF is OFF, inverter stop. Terminal STR is pause. When STR is ON, pause the operation. When STR is OFF, operation continues from section before pausing. For details, please refer to -15(P.100), 04-27(P.101)~04-42(P.118), 04-16(P.121)~04-18(P.123) and 04-19(P.131)~04-26(P.138).

- ◆ Set value: 35 MPO(manual programmed operation):

In external mode, when MPO is “on” run manual cycle operation. For details, please refer to 04-19(P.131) ~ 04-26(P.138).

- ◆ Set value :41 PWM pulse as frequency command ( Terminal HDI only)

Inverter will measure and calculate ON OFF time of every PWM period as frequency command. (Allowable PWM period within 0.9ms ~ 1100ms)

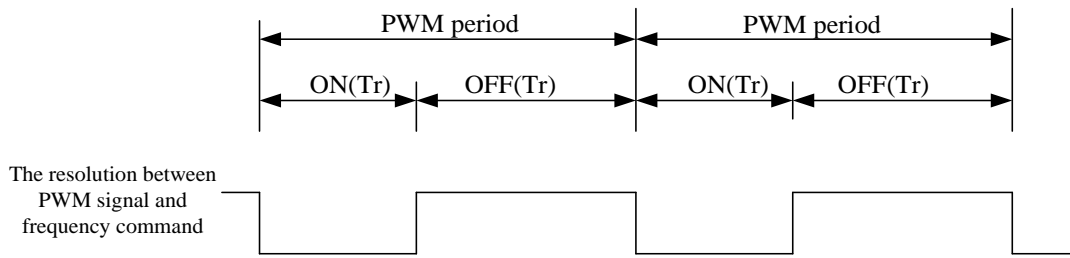

$$\text{Frequency command (Hz)} = \frac{\text{ON time}}{\text{PWM period}} \times \text{upper limit frequency 01-00(P.1)(Hz)}$$

This function is for terminal M2 only, accuracy of signal will be reduced in both lowest and highest allowed period, please avoid using it on occasions requiring high-accuracy. To use high-speed pulse on terminal M2 as target frequency, please refer to [5.3.7 HDI input selection and processing](#).

- ◆ Set value:42 MTCLKA /MTCLKB function (Terminal M0 M1 only)

Set 03-03 (P.80) and 03-04 (P.81) to 42 (MTCLKA/MTCLKB), which can be used as a counting function for quadrature pulse signals (maximum frequency 33KHz), used in places such as quadrature pulse feedback from an encoder signal.

- ◆ Set value : 54 Revs counting signal

This function is used to calculate the number of rotations when roll diameter is calculated by thickness calculation method in tension control mode.

- ◆ Set value : 55 Speed/Torque control

When switch from speed control to torque control, torque limit becomes torque command, speed command becomes speed limit. When switch back from torque control to speed control, torque command becomes torque limit, speed limit becomes speed command. When switch between speed control and torque control, please set closed loop vector control (00-21(P.300) = 4, 5) and speed control (00-20(P.400)= 0). If 00-20(P.400) = 1 and digital input terminal = 55 are set at the same time, the switching function is invalid and only torque control will be performed.

- ◆ Set value : 63 Position/Speed control switch

When switch between speed control and position control, please set closed loop vector control (00-21(P.300) = 4) and position control (00-20(P.400)=2). If 00-20(P.400)=0,1 and digital input terminal =63 are set at the same time, position control won't be on and will only perform speed control or torque control.

Show as below:

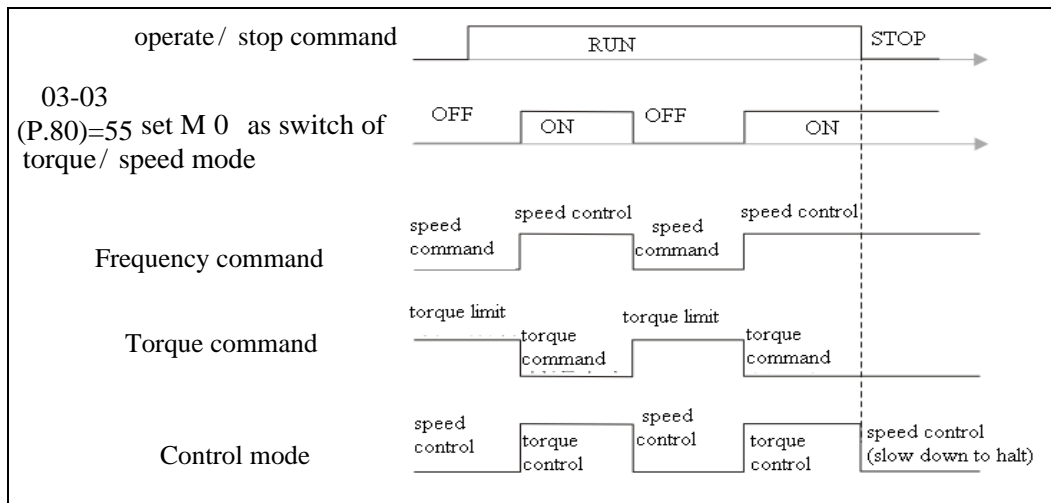

- ◆ Set value :58 Analog terminal 2-5 high priority  
When this terminal is ON, frequency command source priority will force to 2-5. (If the frequency commands are given to 4-5, 2-5 at the same time, the priority is 2-5 > 4-5).
- ◆ Set value :60 Built-in PLC start/stop  
When this terminal is ON, built-in PLC starts; when OFF, PLC stops.
- ◆ Set value :61 SHOM (Homing enable)  
Homing mode will be triggered by upper edge when input signal to this terminal.
- ◆ Set value :62 ORGP (Set homing point)  
ORGP set homing point. When this terminal is on, inverter will execute homing function according to 12-00(P.420), 12-01(P.421) and 12-02(P.422)
- ◆ Set value : 64 External zero-servo switch  
When this terminal is on, do zero-servo function.
- ◆ Set value : 45 Second mode  
When this terminal is on, and parameter 00-16(P.79)=99999, start stop signal is set by 00-18(P.109), target frequency is set by 00-17(P.97)
- ◆ Set value : 65 External accelerate/decelerate pause  
When executing the external accelerate/decelerate pause function, inverter will stop accelerating or decelerating immediately. When signal off, inverter will accelerate/decelerate from the point it paused.

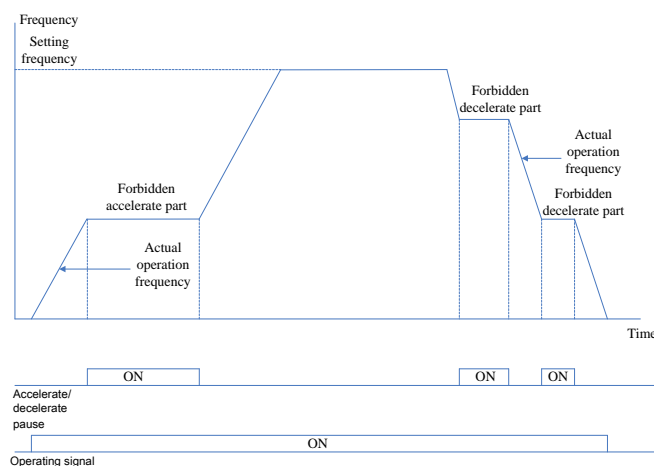

## ◆ Set value : 66 External forced stop

When this terminal is on, the driver will forced stop according to the setting of 00-13(P.71).

## ◆ Set value : 68 Single point positioning

For details please refer to 5.13.4 single point positioning function.

## ◆ Set value : 69 Multipoint positioning

Multipoint positioning is based on single point positioning, and terminal set to enable multipoint positioning (example 03-03(P.80)= 68, 03-04(P.81)= 69). After the single-point positioning is completed, if multipoint positioning terminal is ON, inverter will operate 15-segment position positioning function within one turn of motor according to REX, RH, RM, RL terminal status. Acceleration and deceleration curves will not be used, position is set in 12-21(P.451), 12-23(P.453) ..., please refer to 5.13.5 for detail parameter settings..

## ◆ Set value : 70 Enable entire position control by pulse input command

In speed control add on terminal function, when this terminal is on inverter switch to Pt position control mode, and the function is the same as setting 00-20 (P.400) = 2.

## ◆ Set value : 71 External torque command polarity reverse

When this terminal is on, the direction of rotation is reverse in torque control.

Note: Set value "41", "54" and "57" is for M2 terminal only.

Set valve "42" is for M0, M1 terminal only.

## 5.4.2 Digital output terminals function selection

➤ Detect information generated and send digital signal output during inverter operation.

Parameter	Name	Default	Setting Range	Content
03-10 P.40	SO-SE function	1	0	RUN(Output when inverter running)
			1	SU(Output when reach target frequency)
			2	FU(Output when reach 03-21(P.62) 03-22 (P.63)value )
			3	OL(Output when overload)
			4	OMD(When the percentage of the output current is lower than 03-23 (P.62) and afte (03-24 (P.63))of time, OMD will output)
			5	ALARM(Output when alarm)
			6	PO1(Output when in program operation step)
			7	PO2(Output when in program operation cycle)
			8	PO3(Output when in program operation pause)
			9	BP(Output when use inverter output in function : switch between inverter and commercial power-supply)
			10	GP(Output when use commercial power-supply in function : switch between inverter and commercial power-supply)
			11	OMD1(When inverter reach target frequency and the percentage of the output current is lower than 03-23 (P.62) and afte (03-24 (P.63))of time, OMD will output a signal)
			12 ~ 16	Reserved
			17	RY(Output when inverter is powered on and no alarm)
			18	Output when it's time for maintenance
			19	OL2 (Output when overload 2)
			20	Output when capacitor abnormal
			21	Output when in position control reach position
			22	Output when detect curl in tension control
			23	Output when detect power marker
			24 ~ 40	Reserved
			41	Feedback disconnection alarm
			03-11 P.85	Terminal A-B-C output function

Setting

Digital output terminals function selection

- ◆ Terminal SO default value (03-10(P.40)) is 1 which means "SU". If 03-10(P.40) value is changed, terminal function will change as shown in table above.
- ◆ Terminals SO is "open collector output." Please refer to Section **3.7 Terminal wire arrangement.**
- ◆ Terminal A-B-C default value (03-11(P.85)) is 5 which means "ALARM". If 03-11(P.85) value is changed, terminal function will change as shown in table above.



### 5.4.3 Terminal logic selection

- The function is bits-setting, if the bit shows 1, it means that the action of multi-function digital input terminal is negative logic; otherwise, it means that the action is positive logic.

Parameter	Name	Default	Setting Range	Content
03-14 P.87	Multi-function terminal digital input negative/positive logic	0	0 ~ 1023	---
03-15 P.88	Multi-function terminal digital output negative/positive logic	0	0 ~ 4095	---

#### Setting Digital input/output logic

- ◆ The definition of each bit of 03-14(P.87) is as follows:

bit	$2^5$	$2^4$	$2^3$	$2^2$	$2^1$	$2^0$
	RE S	M2	M1	M0	STR	STF

For example: A three-wire control type needs the function of STOP to be kept open (negative logic). So if set 03-03(P.80)=31, take M0 terminal as three-wire control STOP function, and 03-03(P.80)=0, 03-01(P.84)=1, and take STF and STR terminals as default positive/negative logic function, the parameter of 03-14(P.87) should be set as follows:

bit	$2^9$	$2^8$	$2^7$	$2^6$	$2^5$	$2^4$	$2^3$	$2^2$	$2^1$	$2^0$
	0	0	0	0	0	0	0	1	0	0

$$\text{So } (03-14)P.87 = 0 \times 2^9 + 0 \times 2^8 + 0 \times 2^7 + 0 \times 2^6 + 0 \times 2^5 + 0 \times 2^4 + 0 \times 2^3 + 1 \times 2^2 + 0 \times 2^1 + 0 \times 2^0 = 4$$

- ◆ The definition of each 03-15(P.88) bit is as follows :

bit	$2^{11}$	$2^{10}$	$2^9$	$2^8$	$2^7$	$2^6$	$2^5$	$2^4$	$2^3$	$2^2$	$2^1$	$2^0$
	ABC1 7	ABC1 6	ABC1 5	ABC1 4	ABC1 3	ABC1 2	ABC1 1	ABC1 0	0	0	ABC	SO
----- expanded digital output -----												

For example: 03-11(P.85)=0 (inverter is running and detecting), if positive logic output bit is set as 0, when inverter runs, multi-relay is on. When inverter stops, multi-relay is off; otherwise, if set negative logic bit as 1, when inverter runs, multi-relay is off, and when the inverter stops, multi-relay is on.

Note: When “STF” and “STR” terminals are set as negative logic, but signal is not connected with SD, with power on, inverter will input and drive motor operate. So it is dangerous, you must pay attention to it.

### 5.4.4 Digital output signal delay

- This parameter is used to delay and confirm the digital output signal. Delay time acts like confirmation time, which can prevent some unknown interference

Parameter	Name	Default	Setting Range	Content
03-16 P.120	Output signal delay time	0.0s	0 ~ 3600.0s	---

#### Setting Output signal delay

- ◆ When set 03-16(P.120)=0 and condition from 03-10(P.40), 03-11(P.85) is met, signal will output directly.
- ◆ When set 03-16(P.120) = 0.1~3600 and condition from 03-10(P.40), 03-11(P.85) is met, signal will output after delay time.

### 5.4.5 Digital input signal filter

- This parameter is used to set response time for digital input signals.

Parameter	Name	Default	Setting Range	Content
03-17 P.157	Digital input terminal filter time	8ms	0 ~ 2000ms	---

#### Setting Digital input terminal filter

- ◆ 03-17(P.157) action range includes: STR, STF, RES, M0, M1, M2, and expanded SLOT digital input terminal. The exception is when M2 is in high-speed pulse input mode.

### 5.4.6 Digital input terminal enable when power on

- Choose when power on if digital input terminal operates immediately.

Parameter	Name	Default	Setting Range	Content
03-18 P.158	Digital input terminal enable when power on	0	0	When power on digital terminals work directly
			1	When power on digital terminals work after switch off then on

#### Setting Digital input terminal enable when power on

- ◆ If 03-18(P.158)=1, when terminal function STF, STR, RUN and MPO is already short before power on, after power on inverter will not run immediately, inverter will run only after switch off then on these terminals. If 03-18(P.158)=0, when terminal function STF, STR, RUN and MPO is already short before power on, after power on inverter will run immediately.

## 5.4.7 Output frequency detection

- Detects the inverter output frequency and output signal.

Parameter	Name	Default	Setting Range	Content
03-20 P.41	Output frequency detection sensitivity	10.0%	0 ~ 100.0%	---
03-21 P.42	Output frequency detection for forward rotation	6.00Hz	0 ~ 650.00Hz	---
03-22 P.43	Output frequency detection for reverse rotation	99999	0 ~ 650.00Hz	---
			99999	Same setting as 03-21(P.42).

#### Setting Output frequency detection range

- ◆ If 03-20(P.41)=5%, SU signal will be output when output frequency falls within “5% range around target frequency”. For example, the target frequency is set to 60Hz and 03-20(P.41)=5%, then when output frequency falls within the range of  $60 \pm 60 \times 5\% = 57\text{Hz} \sim 63\text{Hz}$ , SU signal will be output.

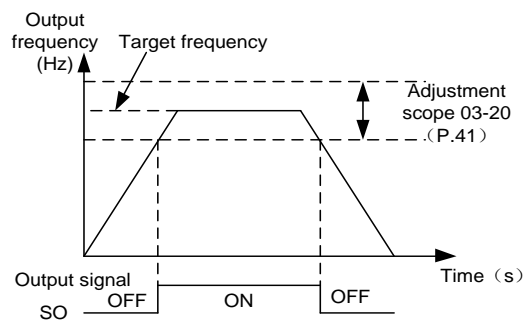

#### Setting Forward rotation output frequency detection

- ◆ If 03-21(P.42)=30 and 03-22(P.43)=20, FU signal will output when forward rotation frequency exceeds 30Hz; and when reverse rotation frequency exceeds 20Hz, FU signal will also be output.
- ◆ If 03-21(P.42)=30 and 03-22(P.43)=99999 (default), FU signal will output when forward and reverse rotation frequency exceed 30Hz.

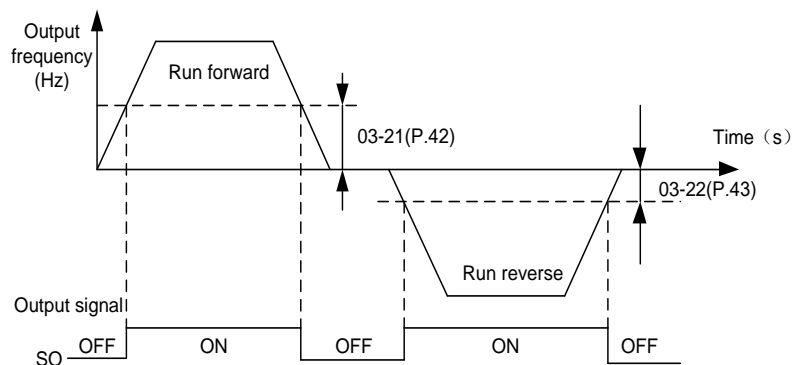

Note: SU and FU mentioned in this paragraph are the function names for digital output. Please refer to 03-10(P.40) , 03-11(P.85) for details, and section **3.7 Terminal wire arrangement.**

### 5.4.8 Zero current detection

➤ Detects output current level and send signal to digital output terminal

Parameter	Name	Default	Setting Range	Content
03-23 P.62	Zero current detection level	5.0%	0 ~ 200.0%	---
			99999	Invalid.
03-24 P.63	Zero current detection time	0.50s	0 ~ 100.00s	---
			99999	Invalid.

**Setting** Zero current detection

◆ Assume inverter is fully loaded at rated value and current is 20A, set 03-23(P.62)=5% and 03-24(P.63)=0.5s, terminal function OMD will output signal when output current is less than  $20 \times 5\% = 1A$  and exceeds 0.5s, as shown below figure:

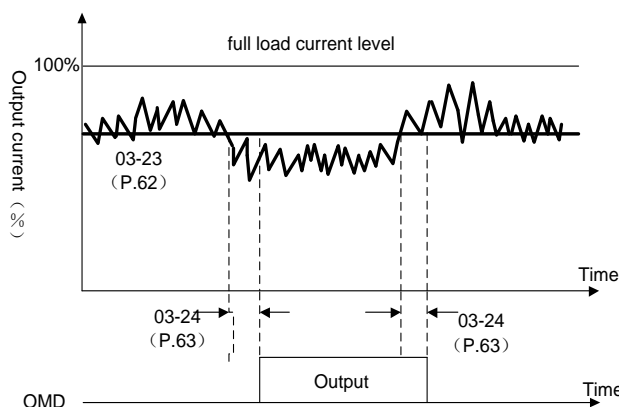

◆ If set 03-23(P.62) or 03-24(P.63) to 99999, zero current detection function is off.

Note: In this paragraph, OMD mentioned in this paragraph are the function names for digital output. Please refer to 03-10(P.40) , 03-11(P.85) for details, and section **3.7 Terminal wire arrangement.**

### 5.4.9 Expanded digital input terminals function selection

➤ Change the digital input terminal function for expansion card SLOT3

Parameter	Name	Default	Setting Range	Content
03-25 P.551	Expanded digital input terminal M10	99999	Same as 03-00(P.83)	Same as 03-00(P.83)
03-26 P.552	Expanded digital input terminal M11	99999	Same as 03-00(P.83)	Same as 03-00(P.83)
03-27 P.553	Expanded digital input terminal M12	99999	Same as 03-00(P.83)	Same as 03-00(P.83)
03-28 P.554	Expanded digital input terminal M13	99999	Same as 03-00(P.83)	Same as 03-00(P.83)
03-29 P.555	Expanded digital input terminal M14	99999	Same as 03-00(P.83)	Same as 03-00(P.83)
03-30 P.556	Expanded digital input terminal M15	99999	Same as 03-00(P.83)	Same as 03-00(P.83)

**Setting** Expanded digital input terminal

◆ The function is the same as the digital input function, please refer to **Section 5.4.1 Digital input function selection.**

### 5.4.10 Expanded digital input terminal logic selection

- This function is set in bits, if bit shows 1, it means the correspond terminal is negative logic; if bit shows 0, it means the correspond terminal is positive logic.

Parameter	Name	Default	Setting Range	Content
03-41 P.567	Expanded digital input terminal logic	0	0 ~ 63	---

Setting Expanded digital input terminal logic

- ◆ The definition of each 03-41 (P.567) bit is as follows:

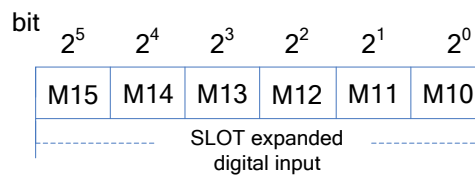

### 5.4.11 Expanded digital output terminal function selection

- Detect information generated and send digital signal output during inverter operation.

Parameter	Name	Default	Setting Range	Content
03-42 P.568	Expanded digital output terminal A10	99999	Same as 03-10(P.40)	Same as 03-10(P.40)
03-43 P.569	Expanded digital output terminal A11	99999	Same as 03-10(P.40)	Same as 03-10(P.40)
03-44 P.570	Expanded digital output terminal A12	99999	Same as 03-10(P.40)	Same as 03-10(P.40)
03-45 P.571	Expanded digital output terminal A13	99999	Same as 03-10(P.40)	Same as 03-10(P.40)
03-46 P.572	Expanded digital output terminal A14	99999	Same as 03-10(P.40)	Same as 03-10(P.40)
03-47 P.573	Expanded digital output terminal A15	99999	Same as 03-10(P.40)	Same as 03-10(P.40)
03-48 P.574	Expanded digital output terminal A16	99999	Same as 03-10(P.40)	Same as 03-10(P.40)
03-49 P.575	Expanded digital output terminal A17	99999	Same as 03-10(P.40)	Same as 03-10(P.40)

Setting Expanded digital output terminal function

- ◆ The function is the same as the digital output function, please refer to [Section 5.4.1 Digital input function selection](#).

### 5.4.12 Digital input / output terminal monitor

➤ Used to monitor the status of digital input / output terminal.

Parameter	Name	Default	Setting Range	Content
03-59 P.585	Monitor inverter input terminal state	Read	Read only	---
03-60 P.586	Monitor inverter and expanded output terminal state	Read	Read only	---
03-61 P.587	Monitor expanded input terminal state	Read	Read only	---

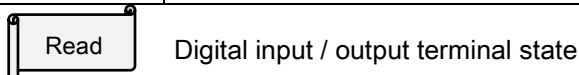

- ◆ For input terminal: 1 means signal is given, 0 means no signal.
- ◆ For output terminal: 1 means signal is outputting, 0 means no output.

Each bit corresponded input terminal of 03-59(P.585):

b15	b14	b13	b12	b11	b10	b9	b8	b7	b6	b5	b4	b3	b2	b1	b0
0	0	0	0	0	0	0	0	0	0	RES	M2	M1	M0	STR	STF

Each bit corresponded output terminal of 03-60(P.586):

b15	b14	b13	b12	b11	b10	b9	b8	b7	b6	b5	b4	b3	b2	b1	b0
0	0	0	0	A17	A16	A15	A14	A13	A12	A11	A10	0	0	ABC	SO
SLOT expanded digital output															

Each bit corresponded input terminal of 03-61(P.587) :

b15	b14	b13	b12	b11	b10	b9	b8	b7	b6	b5	b4	b3	b2	b1	b0
0	0	0	0	0	0	0	0	0	0	M15	M14	M13	M12	M11	M10
SLOT expanded digital input															

Example:

Input terminal:

Set 03-00(P.83) = 0(STF), forward rotation signal; 03-03(P.80) = 5(M0), Analog terminal 4-5 priority, other terminals are default value. After terminal STF and M0 close, inverter operates in forward rotation according to the frequency given by 4-5. Each bit in 03-59(P.585) is as follows, indicating the operation of STF and M0.

bit	b9	b8	b7	b6	b5	b4	b3	b2	b1	b0
	0	0	0	0	0	0	0	1	0	1

So  $03-59(P.585) = 0 \times 2^9 + 0 \times 2^8 + 0 \times 2^7 + 0 \times 2^6 + 0 \times 2^5 + 0 \times 2^4 + 0 \times 2^3 + 1 \times 2^2 + 0 \times 2^1 + 1 \times 2^0 = 5$

Output terminal:

03-42(P.568) (A10), RUN signal detected; 03-49(P.575) (A17) is set set to 2(FU output frequency detected), other terminals are default value. Insert the expansion card; after the inverter operates to the target frequency, the state of 03-60(P.586) is as follows, indicating the output of A17 and A10.

bit	b11	b10	b9	b8	b7	b6	b5	b4	b3	b2	b1	b0
	1	0	0	0	0	0	0	1	0	0	0	0

So  $03-60(P.586) = 1 \times 2^{11} + 0 \times 2^{10} + 0 \times 2^9 + 0 \times 2^8 + 0 \times 2^7 + 0 \times 2^6 + 0 \times 2^5 + 1 \times 2^4 + 0 \times 2^3 + 0 \times 2^2 + 0 \times 2^1 + 0 \times 2^0 = 2064$

## 5.5 Multi-speed parameter group 04

Group	Parameter Number	Name	Setting Range	Default	Page
04-00	P.4	Speed1(high speed)	0 ~ 650.00Hz	60.00Hz	<a href="#">135</a>
04-01	P.5	Speed2(mediumspeed)	0 ~ 650.00Hz	30.00Hz	<a href="#">135</a>
04-02	P.6	Speed3(low speed)	0 ~ 650.00Hz	10.00Hz	<a href="#">135</a>
04-03	P.24	Speed4	0 ~ 650.00Hz	99999	<a href="#">135</a>
			99999: Function invalid		
04-04	P.25	Speed5	Same as 04-03(P.24)	99999	<a href="#">135</a>
04-05	P.26	Speed6	Same as 04-03(P.24)	99999	<a href="#">135</a>
04-06	P.27	Speed7	Same as 04-03(P.24)	99999	<a href="#">135</a>
04-07	P.142	Speed8	Same as 04-03(P.24)	99999	<a href="#">135</a>
04-08	P.143	Speed9	Same as 04-03(P.24)	99999	<a href="#">135</a>
04-09	P.144	Speed10	Same as 04-03(P.24)	99999	<a href="#">135</a>
04-10	P.145	Speed11	Same as 04-03(P.24)	99999	<a href="#">135</a>
04-11	P.146	Speed12	Same as 04-03(P.24)	99999	<a href="#">135</a>
04-12	P.147	Speed13	Same as 04-03(P.24)	99999	<a href="#">135</a>
04-13	P.148	Speed14	Same as 04-03(P.24)	99999	<a href="#">135</a>
04-14	P.149	Speed15	Same as 04-03(P.24)	99999	<a href="#">135</a>
04-15	P.100	Programmed operation minute / second selection	0: Select minute as the time increment.	1	<a href="#">137</a>
			1: Select second as the time increment.		
04-16	P.121	Run direction in each section	0 ~ 255	0	<a href="#">137</a>
04-17	P.122	Programmed operation cycle selection	0:Off	0	<a href="#">137</a>
			1 ~ 8: Start cycle from the set section.		
04-18	P.123	Programmed operation acceleration / deceleration time setting selection	0: Acceleration time is 01-06(P.7), deceleration time is 01-07(P.8).	0	<a href="#">137</a>
			1: Acceleration and deceleration time is set by 04-35(P.111) ~ 04-42(P.118).		
04-19	P.131	Programmed operation mode speed 1	0 ~ 650.00Hz	0.00 Hz	<a href="#">137</a>
04-20	P.132	Programmed operation mode speed 2	0 ~ 650.00Hz	0.00 Hz	<a href="#">137</a>
04-21	P.133	Programmed operation mode speed 3	0 ~ 650.00Hz	0.00 Hz	<a href="#">137</a>
04-22	P.134	Programmed operation mode speed 4	0 ~ 650.00Hz	0.00 Hz	<a href="#">137</a>
04-23	P.135	Programmed operation mode speed 5	0 ~ 650.00Hz	0.00 Hz	<a href="#">137</a>
04-24	P.136	Programmed operation mode speed 6	0 ~ 650.00Hz	0.00 Hz	<a href="#">137</a>
04-25	P.137	Programmed operation mode speed 7	0 ~ 650.00Hz	0.00 Hz	<a href="#">137</a>
04-26	P.138	Programmed operation mode speed 8	0 ~ 650.00Hz	0.00 Hz	<a href="#">137</a>

## Multi-speed parameter group 04

Group	Parameter Number	Name	Setting Range	Default	Page
04-27	P.101	Programmed operation mode speed 1 operating time	0 ~ 6000.0s	0.0s	<a href="#">137</a>
04-28	P.102	Programmed operation mode speed 2 operating time	0 ~ 6000.0s	0.0s	<a href="#">137</a>
04-29	P.103	Programmed operation mode speed 3 operating time	0 ~ 6000.0s	0.0s	<a href="#">137</a>
04-30	P.104	Programmed operation mode speed 4 operating time	0 ~ 6000.0s	0.0s	<a href="#">137</a>
04-31	P.105	Programmed operation mode speed 5 operating time	0 ~ 6000.0s	0.0s	<a href="#">137</a>
04-32	P.106	Programmed operation mode speed 6 operating time	0 ~ 6000.0s	0.0s	<a href="#">137</a>
04-33	P.107	Programmed operation mode speed 7 operating time	0 ~ 6000.0s	0.0s	<a href="#">137</a>
04-34	P.108	Programmed operation mode speed 8 operating time	0 ~ 6000.0s	0.0s	<a href="#">137</a>
04-35	P.111	Programmed operation mode speed 1 Acc/Dec time	0 ~ 600.00s/0 ~ 6000.0s	0.00s	<a href="#">137</a>
04-36	P.112	Programmed operation mode speed 2 Acc/Dec time	0 ~ 600.00s/0 ~ 6000.0s	0.00s	<a href="#">137</a>
04-37	P.113	Programmed operation mode speed 3 Acc/Dec time	0 ~ 600.00s/0 ~ 6000.0s	0.00s	<a href="#">138</a>
04-38	P.114	Programmed operation mode speed 4 Acc/Dec time	0 ~ 600.00s/0 ~ 6000.0s	0.00s	<a href="#">138</a>
04-39	P.115	Programmed operation mode speed 5 Acc/Dec time	0 ~ 600.00s/0 ~ 6000.0s	0.00s	<a href="#">138</a>
04-40	P.116	Programmed operation mode speed 6 Acc/Dec time	0 ~ 600.00s/0 ~ 6000.0s	0.00s	<a href="#">138</a>
04-41	P.117	Programmed operation mode speed 7 Acc/Dec time	0 ~ 600.00s/0 ~ 6000.0s	0.00s	<a href="#">138</a>
04-42	P.118	Programmed operation mode speed 8 Acc/Dec time	0 ~ 600.00s/0 ~ 6000.0s	0.00s	<a href="#">138</a>



## 5.5.1 16 steps speed

- With the combination of digital input terminal RL, RM, RH and REX, 16 steps speed can be selected (up to 16 speeds)

Parameter	Name	Default	Setting Range	Content
04-00 P.4	Speed1(high speed)	60.00Hz	0 ~ 650.00Hz	---
04-01 P.5	Speed2 (medium speed)	30.00Hz	0 ~ 650.00Hz	---
04-02 P.6	Speed3(low speed)	10.00Hz	0 ~ 650.00Hz	---
04-03 P.24	Speed4	99999	0 ~ 650.00Hz	---
			99999	99999: Off
04-04 P.25	Speed5	99999	Same as 04-03(P.24)	Same as 04-03(P.24)
04-05 P.26	Speed6	99999	Same as 04-03(P.24)	Same as 04-03(P.24)
04-06 P.27	Speed7	99999	Same as 04-03(P.24)	Same as 04-03(P.24)
04-07 P.142	Speed8	99999	Same as 04-03(P.24)	Same as 04-03(P.24)
04-08 P.143	Speed9	99999	Same as 04-03(P.24)	Same as 04-03(P.24)
04-09 P.144	Speed10	99999	Same as 04-03(P.24)	Same as 04-03(P.24)
04-10 P.145	Speed11	99999	Same as 04-03(P.24)	Same as 04-03(P.24)
04-11 P.146	Speed12	99999	Same as 04-03(P.24)	Same as 04-03(P.24)
04-12 P.147	Speed13	99999	Same as 04-03(P.24)	Same as 04-03(P.24)
04-13 P.148	Speed14	99999	Same as 04-03(P.24)	Same as 04-03(P.24)
04-14 P.149	Speed15	99999	Same as 04-03(P.24)	Same as 04-03(P.24)

**Setting** 16 steps speed

- ◆ If all the values of 04-03(P.24)~04-06(P.27) and 04-07(P.142)~04-14(P.149) are not 99999, “16 steps speed” is active. It means with the combination of RL, RM, RH and REX, there are 16 speeds in total. To set target frequency for inverter, please refer to the figure below:

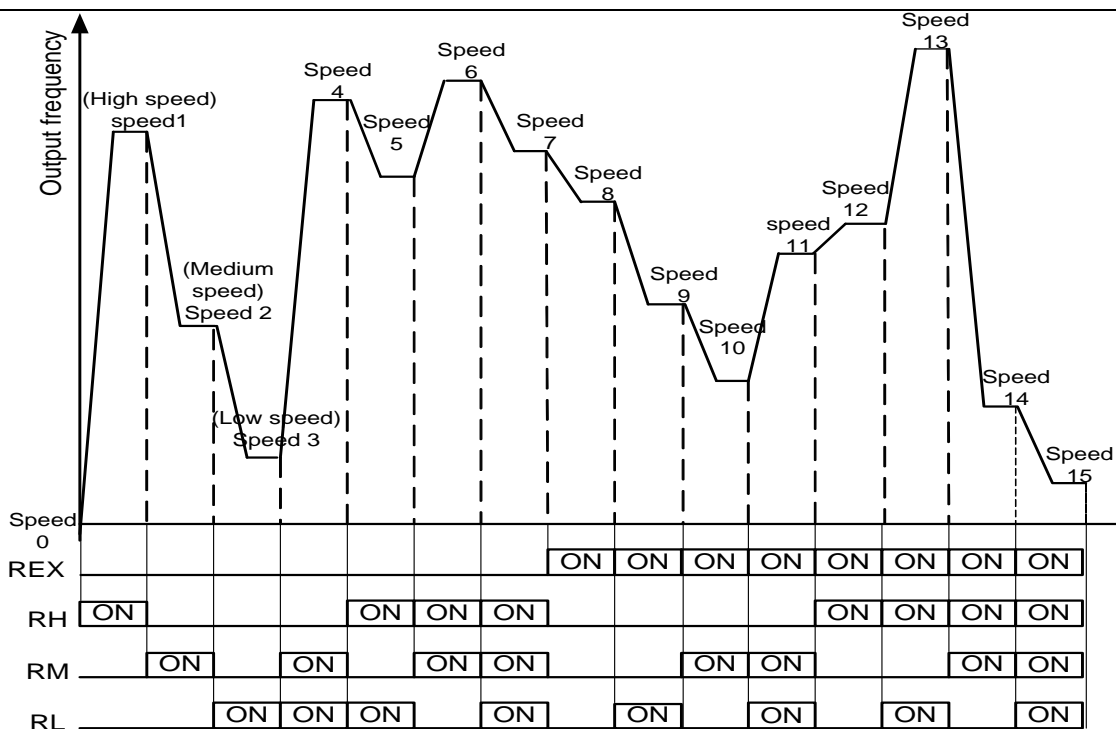

- ◆ When one of parameters 04-03(P.24)~04-06(P.27) and 04-07(P.142)~04-14(P.149) value is 99999, the target frequency is determined by the speed of RL, RM and RH, which is shown as below (the priority of terminals is  $RL > RM > RH$ ):

Parameter	04-03 (P.24)= 99999	04-04 (P.25)= 99999	04-05 (P.26)= 99999	04-06 (P.27)= 99999	04-07 (P.142) = 99999	04-08 (P.143) = 99999	04-09 (P.144) = 99999	04-10 (P.145) = 99999	04-11 (P.146) = 99999	04-12 (P.147) = 99999	04-13 (P.148) = 99999	04-14 (P.149) = 99999
RL(04-02)	○	○		○	○	○		○		○		○
RM(04-01)			○				○				○	
RH(04-00)									○			

For example, when 04-05(P.26) = 99999, the target frequency is determined by RM(the setting value of 04-01(P.5)).

Note: 1. Multi-speed is only valid in “external mode”, “combination mode 2” or “combined mode 4”.

2. RL, RM, RH and REX mentioned in this section are the function names of the “multi-function digital input terminal”. (For example, when 03-03(P.80)=2, select the M0 terminal to perform the RL (function). Please refer to 03-00~03-05(P.80~P.84, P.86) for function selection and purposes of the multi-function digital input terminal. For related wiring, please refer to Section 3.7 Terminal wire arrangement.

## 5.5.2 Programmed operation mode

- The application of this parameter can be used as the operation process control for general small machinery, food processing machinery and washing equipment, which can replace some traditional relays, switches, timer and other control circuit, etc.

Parameter	Name	Default	Setting Range	Content
04-15 P.100	Programmed operation minute / second selection	1	0	Select minute as the time increment.
			1	Select second as the time increment.
04-16 P.121	Run direction in each section	0	0 ~ 255	0 ~ 255
04-17 P.122	Programmed operation cycle selection	0	0	Off
			1 ~ 8	Start cycle from the set section.
04-18 P.123	Programmed operation acceleration / deceleration time setting selection	0	0	Acceleration time is 01-06(P.7), deceleration time is 01-07 (P.8).
			1	Acceleration and deceleration time is set by 04-35 (P.111) ~ 04-42 (P.118).
04-19 P.131	Programmed operation mode speed 1	0.00Hz	0 ~ 650.00Hz	---
04-20 P.132	Programmed operation mode speed 2	0.00Hz	0 ~ 650.00Hz	---
04-21 P.133	Programmed operation mode speed 3	0.00Hz	0 ~ 650.00Hz	---
04-22 P.134	Programmed operation mode speed 4	0.00Hz	0 ~ 650.00Hz	---
04-23 P.135	Programmed operation mode speed 5	0.00Hz	0 ~ 650.00Hz	---
04-24 P.136	Programmed operation mode speed 6	0.00Hz	0 ~ 650.00Hz	---
04-25 P.137	Programmed operation mode speed 7	0.00Hz	0 ~ 650.00Hz	---
04-26 P.138	Programmed operation mode speed 8	0.00Hz	0 ~ 650.00Hz	---
04-27 P.101	Programmed operation mode speed 1 operating time	0.0s	0 ~ 6000.0s	---
04-28 P.102	Programmed operation mode speed 2 operating time	0.0s	0 ~ 6000.0s	---
04-29 P.103	Programmed operation mode speed 3 operating time	0.0s	0 ~ 6000.0s	---
04-30 P.104	Programmed operation mode speed 4 operating time	0.0s	0 ~ 6000.0s	---
04-31 P.105	Programmed operation mode speed 5 operating time	0.0s	0 ~ 6000.0s	---
04-32 P.106	Programmed operation mode speed 6 operating time	0.0s	0 ~ 6000.0s	---
04-33 P.107	Programmed operation mode speed 7 operating time	0.0s	0 ~ 6000.0s	---
04-34 P.108	Programmed operation mode speed 8 operating time	0.0s	0 ~ 6000.0s	---
04-35 P.111	Programmed operation mode speed 1 Acc/Dec time	0.00s	0 ~ 600.00s/ 0 ~ 6000.0s	---
04-36 P.112	Programmed operation mode speed 2 Acc/Dec time	0.00s	0 ~ 600.00s/ 0 ~ 6000.0s	---

## Multi-speed parameter group 04

Parameter	Name	Default	Setting Range	Content
04-37 P.113	Programmed operation mode speed 3 Acc/Dec time	0.00s	0 ~ 600.00s/ 0 ~ 6000.0s	---
04-38 P.114	Programmed operation mode speed 4 Acc/Dec time	0.00s	0 ~ 600.00s/ 0 ~ 6000.0s	---
04-39 P.115	Programmed operation mode speed 5 Acc/Dec time	0.00s	0 ~ 600.00s/ 0 ~ 6000.0s	---
04-40 P.116	Programmed operation mode speed 6 Acc/Dec time	0.00s	0 ~ 600.00s/ 0 ~ 6000.0s	---
04-41 P.117	Programmed operation mode speed 7 Acc/Dec time	0.00s	0 ~ 600.00s/ 0 ~ 6000.0s	---
04-42 P.118	Programmed operation mode speed 8 Acc/Dec time	0.00s	0 ~ 600.00s/ 0 ~ 6000.0s	---

### Setting Programmed operation mode

#### ◆ Programmed operation mode

- The calculation method of running time and acceleration/deceleration time for each speed is shown in the following figure:

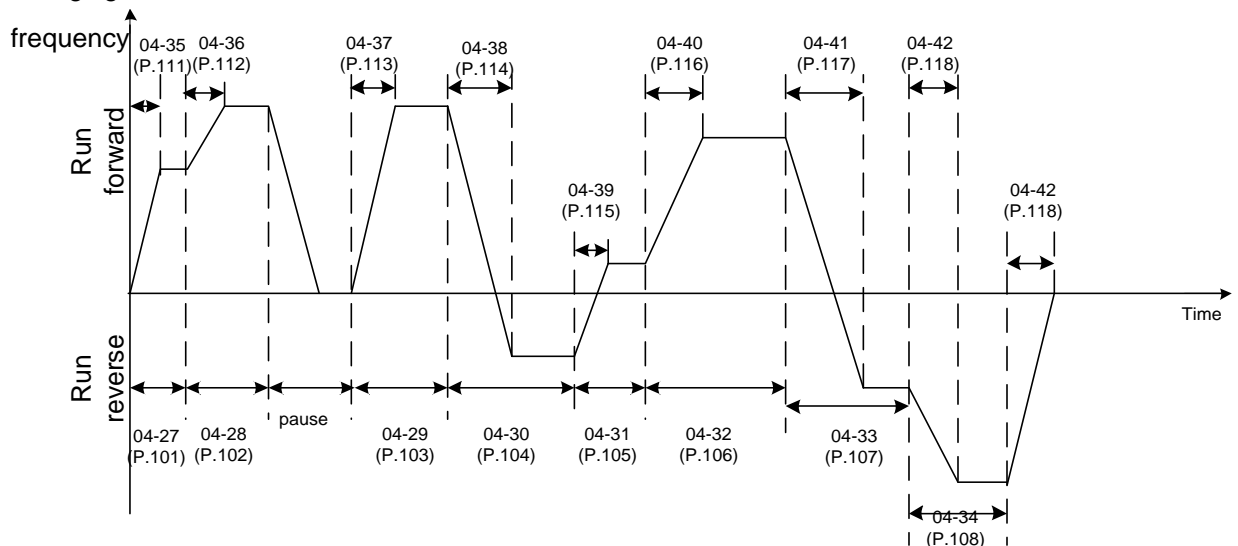

- Setting method of operation direction: set in binary (8 bit), then convert into decimal and set in parameter 04-16. Wherein, 1 means forward rotation, 0 means reverse rotation, the highest bit is the direction of speed 8, and the lowest bit is the direction of speed 1.  
For example: if speed 1 is forward, speed 2 is reverse, speed 3 is reverse, speed 4 is forward, speed 5 is reverse, speed 6 is forward, speed 7 is forward, and speed 8 is reverse, then the binary number is 01101001.  
 $04-16(P.121) = 0 \times 2^7 + 1 \times 2^6 + 1 \times 2^5 + 0 \times 2^4 + 1 \times 2^3 + 0 \times 2^2 + 0 \times 2^1 + 1 \times 2^0 = 105$
- When 04-16(P.121) is set to 0, there will be no cycle operation.
- When 04-17(P.122) is 1~8, it is the section that will cycle to after the first cycle.  
For example: When 04-17(P.122)=3, the cycle operation will start from speed 3 after the speed 1 to speed 8 operations have been completed.
- When 04-18(P.123) is set to 0, the acceleration time is 01-06(P.7), and the deceleration time is 01-07(P.8).
- When 04-18(P.123) is set to 1, the acceleration time and deceleration time are both determined by 04-35(P.111)~ 04-42(P.118). If any value in 04-35 (P.111) ~ 04-42 (P.118) is set to 0, the acceleration time will still be 01-06 (P.7), 01-07 (P.8).

## ◆ Manual cycle mode

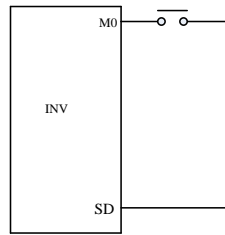

Wiring diagram for manual cycle mode

1. Connect a push button between M0 and SD.
2. After powered on, set the correspond parameter 03-03(P.80) to 35 according to the terminal. At this time, the inverter is in standby state.
3. Operation is shown in the figure below:

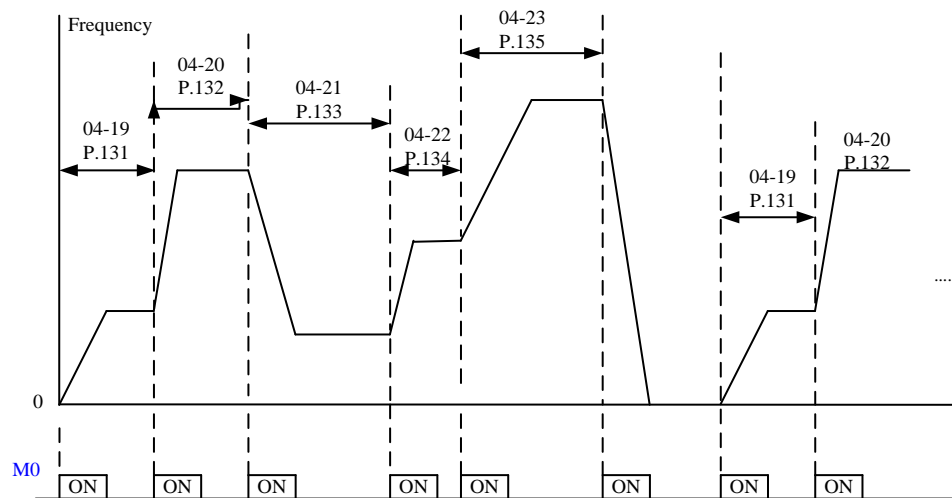

- Note:
1. This program can run 8 speeds at most, which can be set by 04-19(P.131)~04-26(P.138).
  2. Settings for parameters 04-15(P.100)~04-18(P.123) and 04-27(P.101)~04-42(P.118) are only for the programmed operation mode not manual cycle mode. For the acceleration and deceleration time of manual cycle mode, please refer to 01-06(P.7), 01-07(P.8), 01-22(P.44) and 01-23(P.45).
  3. If any segment is set to zero, inverter will return to standby state when run to this segment. This means that when this mode is selected, 04-19(P.131) cannot be 0. As shown in the above diagram, if 04-24(P.136) is 0, regardless of the values of 04-25(P.137) and 04-26(P.138), inverter will stop running when the switch is pressed for the sixth time.
  4. Manual cycle function rotation direction is single direction, which has nothing to do with the operation direction parameter 04-16(P.121) of each speed in the programmed operation mode, and has nothing to do with STF and STR signals.
  5. For 04-35(P.111)~04-42(P.118), please refer to acceleration and deceleration time increments parameter 01-08(P.21).

## 5.6 Motor parameter group 05

Group	Parameter Number	Name	Setting Range	Default	Page
05-00	P.301	Motor specifications automatic measurement	0: Off	0	<a href="#">142</a>
			1: Induction motor specifications automatic measurement 1 (Run motor to measure)		
			2: Induction motor specifications automatic measurement 2 (Don't run motor to measure)		
			3: Induction motor specifications automatic measurement (Measure when operating)		
			4:Reserved		
			5 : Induction motor specifications automatic measurement (Don't run motor to measure)		
			8: Synchronous motor specifications automatic measurement (Run motor to measure)		
			9: Synchronous motor phase Z position automatic measurement (Run motor to measure)		
10: Synchronous motor/Induction motor rotation inertia automatic measurement (Run motor to measure)					
05-01	P.302	Motor rated power	0 ~ 650.00kW	0.00kW	<a href="#">145</a>
05-02	P.303	Motor poles	0 ~ 256	4	<a href="#">145</a>
05-03	P.304	Motor rated voltage	440 Voltage : 0 ~ 510V	According to voltage	<a href="#">145</a>
			220 Voltage : 0 ~255V		
05-04	P.305	Motor rated frequency	50Hz system: 0 ~ 650.00Hz	50.00Hz	<a href="#">145</a>
			60Hz system: 0 ~ 650.00Hz	60.00Hz	
05-05	P.306	Motor rated current	0~500.00A	According to kW	<a href="#">145</a>
05-06	P.307	Motor rated rotation speed	50Hz system: 0 ~ 65000r/min	1410r/min	<a href="#">145</a>
			60Hz system: 0 ~ 65000r/min	1710r/min	
05-07	P.308	Motor excitation current	0~500.00A	According to kW	<a href="#">145</a>
05-08	P.309	IM motor stator resistance	0 ~ 65000mΩ	According to kW	<a href="#">145</a>
05-09	P.310	IM motor rotor resistance	0 ~ 65000mΩ	According to kW	<a href="#">145</a>
05-10	P.311	IM motor leakage inductance	0 ~ 6500.0mH	According to kW	<a href="#">145</a>
05-11	P.312	IM motor mutual inductance	0 ~ 6500.0mH	According to kW	<a href="#">145</a>
05-12	P.313	PM motor stator resistance	0 ~ 65000mΩ	According to kW	<a href="#">145</a>
05-13	P.314	PM motor d-axis inductance	0 ~ 650.00mH	According to kW	<a href="#">145</a>
05-14	P.315	PM motor q-axis inductance	0 ~ 650.00mH	According to kW	<a href="#">145</a>

Group	Parameter Number	Name	Setting Range	Default	Page
05-15	P.316	PM motor Back-EMF coefficient	0 ~ 6500.0V/krpm	According to kW	<a href="#">145</a>
05-16	P.317	PM motor Phase Z origin pulse compensation	0 ~ 359.9°	0.0°	<a href="#">145</a>
05-17	P.318	Motor inertia	0 ~ 6500.0kg. cm2: 5.5K and below 0 ~ 65000kg.cm2: 7.5K~ 22kW	According to kW	<a href="#">147</a>
05-18	P.319	Load inertia ratio	0~600.0	1.0	<a href="#">147</a>
05-19	P.391	Inertia identification speed limit	0~100%	50%	<a href="#">147</a>
05-20	P.392	Acceleration and deceleration time of inertia identification	0 ~ 20.0s	2.0s	<a href="#">147</a>
05-21	P.393	Operation mode of inertia identification	0: one direction rotation 1: both direction rotation	1	<a href="#">147</a>
05-22	P.332	Second motor rated power	0 ~ 650.00kW 99999	99999	<a href="#">148</a>
05-23	P.333	Second motor poles	0 ~ 256 99999	99999	<a href="#">148</a>
05-24	P.334	Second motor rated voltage	440 Voltage : 0 ~ 510V 220 Voltage : 0~255V 99999	99999	<a href="#">148</a>
05-25	P.335	Second motor rated frequency	0 ~ 650.00Hz 99999	99999	<a href="#">148</a>
05-26	P.336	Second motor rated current	0~500.00A 99999	99999	<a href="#">148</a>
05-27	P.337	Second motor rated rotation speed	0 ~ 65000r/min 99999	99999	<a href="#">148</a>
05-28	P.338	Second motor excitation current	0 ~ 500.00A 99999	99999	<a href="#">148</a>
05-29	P.339	Second motor (IM)stator resistance	0 ~ 65000mΩ 99999	99999	<a href="#">148</a>
05-30	P.340	Second motor (IM)rotor resistance	0 ~ 65000mΩ 99999	99999	<a href="#">148</a>
05-31	P.341	Second motor (IM)leakage inductance	0 ~ 6500.0mH 99999	99999	<a href="#">148</a>
05-32	P.342	Second motor (IM)mutual inductance	0 ~ 6500.0mH 99999	99999	<a href="#">148</a>
05-33	P.343	Second motor (PM) stator resistance	0 ~ 65000mΩ 99999	99999	<a href="#">148</a>
05-34	P.344	Second motor (PM) d-axis inductance	0 ~ 650.00mH 99999	99999	<a href="#">148</a>
05-35	P.345	Second motor (PM)q-axis inductance	0 ~ 650.00mH 99999	99999	<a href="#">148</a>
05-36	P.346	Second motor (PM) Back-EMF coefficient	0 ~ 6500.0V/krpm 99999	99999	<a href="#">149</a>
05-37	P.347	Second motor (PM) Phase Z origin pulse compensation	0 ~ 359.9° 99999	99999	<a href="#">149</a>

## Motor parameter group 05

Group	Parameter Number	Name	Setting Range	Default	Page
05-38	P.394	Second motor inertia	0 ~ 6500.0kg. cm <sup>2</sup> : 5.5k and below	99999	<u>149</u>
			0 ~ 65000kg. cm <sup>2</sup> : 7.5k ~ 22K model		
			9999		
05-39	P.395	Second motor load inertia ratio	0~600.0	99999	<u>149</u>
			9999		

### 5.6.1 Motor parameter automatic measurement

➤ By accurate motor parameter measuring function, realize motor high-performance vector control.

Parameter	Name	Default	Setting Range	Content
05-00 P.301	Motor specifications automatic measurement	0	0	Off
			1	Induction motor specifications automatic measurement 1(Run motor to measure)
			2	Induction motor specifications automatic measurement 2(Don't run motor to measure)
			3	Induction motor specifications automatic measurement (Measure when operating)
			4	Reserved
			5	Induction motor specifications automatic measurement (Don't run motor to measure)
			8	Synchronous motor specifications automatic measurement (Run motor to measure)
			9	Synchronous motor phase Z position automatic measurement (Run motor to measure)
			10	Synchronous motor/ Induction motor rotation inertia automatic measurement (Run motor to measure)

 Setting Motor parameter automatic measurement

- ◆ If 00-21(P.300)=0, inverter operate normally according to V/F curve without automatic measuring motor parameters.
- ◆ When controlling induction motor by general flux vector control, please set 00-21(P.300) as 2. Voltage will increase to compensate for the frequency change when the motor load increases.
- ◆ To do induction motor parameter automatic measurement function, in PU mode set 05-00(P.301) as 1, 2 or 5, and press forward or reverse rotation key. During measurement, keypad will flash and display "TUN". If measurement fails, keypad will flash "FAL" for three seconds.
- ◆ 05-00(P.301)=1 is induction motor Auto-tuning mode by rotation. The motor runs during measurement. When selecting this mode, please make sure motor is unloaded.
- ◆ 05-00(P.301)=2 is static induction motor Auto-tuning mode 1. the motor does not run during the measurement
- ◆ 05-00(P.301)=5 is static induction motor Auto-tuning mode 2. the motor does not run during the measurement



- ◆ Automatic induction motor parameters measurement includes the following steps:

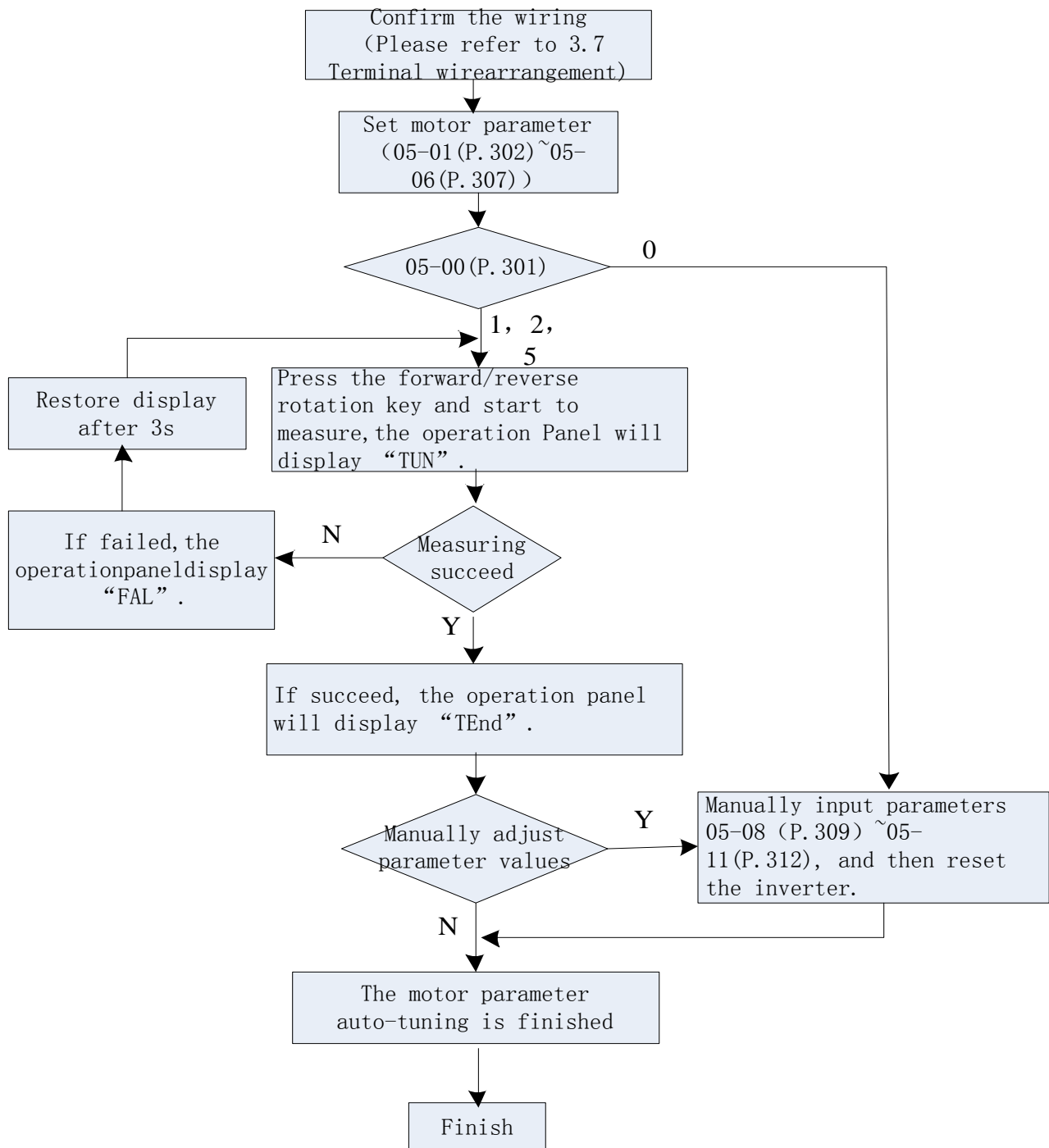

- ◆ When set 00-21(P.300) to 5 or 6, please set the PM motor parameters correctly and do automatic PM motor parameters measurement function, to ensure the control stability and dynamic response.
- ◆ When set 00-21(P.300) to 5, if encoder or motor UVW wiring order is changed, please set 05-00(P.301) to 9 to execute PM motor Phase Z measurement function.

- ◆ Procedures for PM motor parameter measurement includes the following steps:

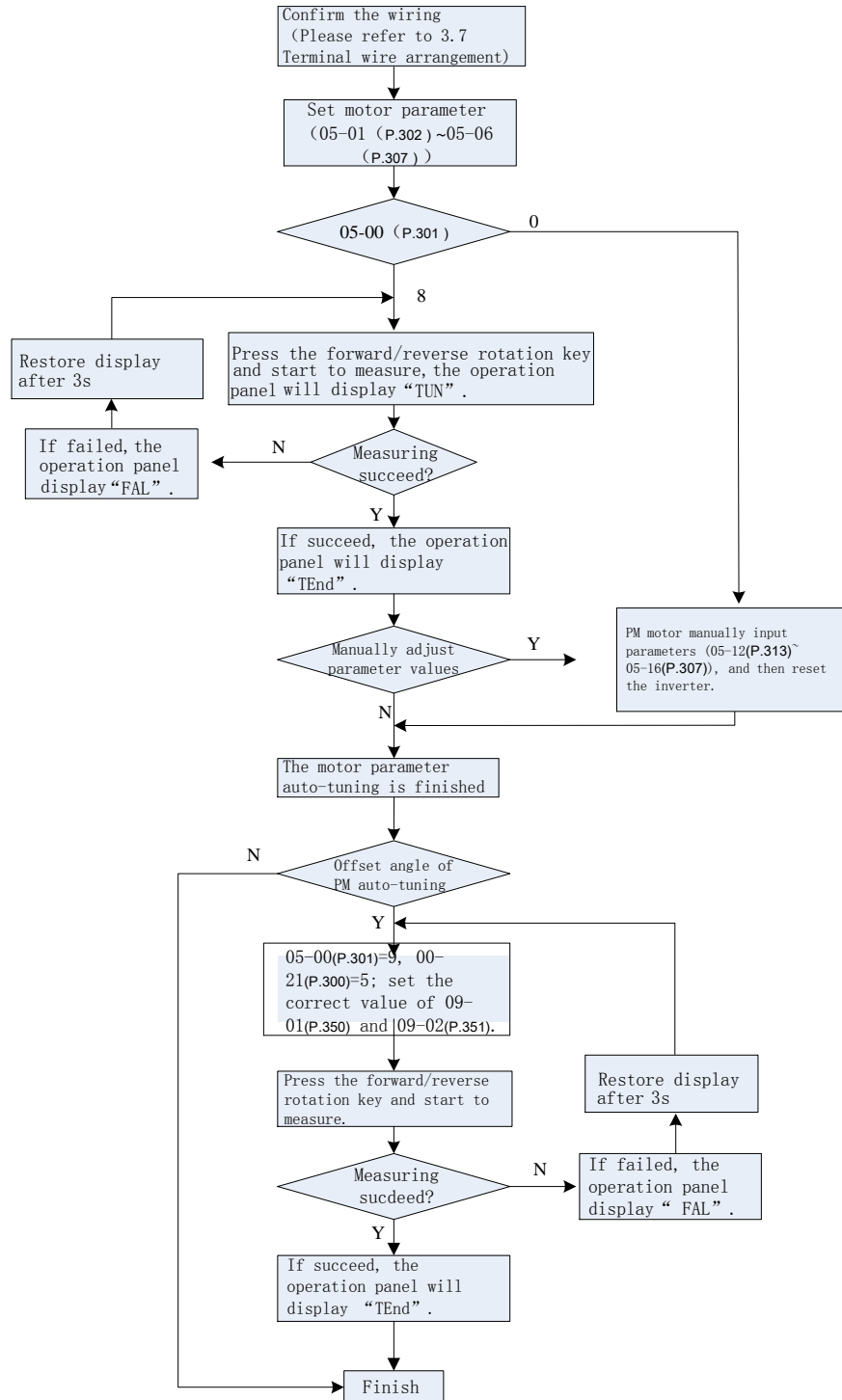

- ◆ If need induction motor high accuracy sensorless control, set 05-00(P.301) to 3 for sensorless vector control.

Note: 1. Motor capacity must be the same level or one level lower than inverter capacity.

2. Induction motor automatic measurement: if motor can run freely, set 05-00(P.301) to 1. Load has to be separated from the motor so the motor can turn freely. If the environment does not permit free run, set 05-00(P.301) to 2 or 5.

3. Induction motor sensorless vector control: automatic measurement function can be used to enhance the control function. Before setting 05-00(P.301) to 3, set the motor parameters first and then do automatic measurement function to improve the control accuracy.

4. When set 05-00(P.301) to 1 (VF + PG), please make sure motor poles 05-02 is correct

## 5.6.2 Motor parameter

- Inverter has built-in standard parameters for motor. Modify the default values according to the actual situation to conform to the actual values as much as possible.

Parameter	Name	Default	Setting Range	Content
05-01 P.302	Motor rated power	0.00kW	0 ~ 650.00kW	---
05-02 P.303	Motor poles	4	0 ~ 256	---
05-03 P.304	Motor rated voltage	380/440V	0 ~ 510V	440V voltage
		220V	0 ~ 255V	220V voltage
05-04 P.305	Motor rated frequency	50.00Hz	0 ~ 650.00Hz	50Hz system (when 00-24(P.189)=1)
		60.00Hz		60Hz system (when 00-24(P.189)=0)
05-05 P.306	Motor rated current	According to kW	0 ~ 500.00A	---
05-06 P.307	Motor rated rotation speed	1410r/min	0 ~ 65000r/min	50Hz system (when 00-24(P.189)=1)
		1710r/min		60Hz system (when 00-24(P.189)=0)
05-07 P.308	Motor excitation current	According to kW	0 ~ 500.00A	---
05-08 P.309	IM motor stator resistance	According to kW	0 ~ 65000mΩ	---
05-09 P.310	IM motor rotor resistance	According to kW	0 ~ 65000mΩ	---
05-10 P.311	IM motor leakage inductance	According to kW	0 ~ 6500.0mH	---
05-11 P.312	IM motor mutual inductance	According to kW	0 ~ 6500.0mH	---
05-12 P.313	PM motor stator resistance	According to kW	0 ~ 65000mΩ	---
05-13 P.314	PM motor d-axis inductance	According to kW	0 ~ 650.00mH	---
05-14 P.315	PM motor q-axis inductance	According to kW	0 ~ 650.00mH	---
05-15 P.316	PM motor Back-EMF coefficient	According to kW	0 ~ 6500.0V/krpm	---
05-16 P.317	PM motor Phase Z origin pulse compensation	0.0°	0 ~ 359.9°	---

Setting

Motor parameter

- ◆ If induction motor can be completely disconnected from the load, select 05-00(P.301)=1, then press  or  on keypad, and inverter will automatically calculate following parameters: 05-07(P.308)~05-11(P.312).
- ◆ If induction motor cannot be completely separated from the load, select 05-00(P.301)=2, then press  or  on keypad, and inverter will automatically calculate following parameters: 05-07(P.308)~05-11(P.312).
- ◆ Users can also calculate this two parameters according to motor nameplate, parameters motor nameplate used are: rated voltage U, rated current I, rated frequency f and power factor  $\eta$
- ◆ Calculation method of no-load excitation current and mutual inductance of the motor is as follows, where  $L_{\delta}$  is leakage inductance of the motor.

Idling current:  $I_0 = I \times \sqrt{1 - \eta^2}$

Mutual inductance calculation: 
$$L_m = \frac{U}{2\sqrt{3} \cdot \pi \cdot f \cdot I_0} - L_{\delta}$$

$I_0$  is the idling current,  $L_m$  is mutual inductance,  $L_{\delta}$  is leakage inductance.

- ◆ When performing PM motor parameter auto-tuning, select 05-00(P.301)=8 and press  or  on keypad to perform PM motor parameter auto-tuning. Inverter will calculate following parameters: 05-12(P.313)~05-16(P.317).
- ◆ When performing PM motor Phase Z position auto-tuning function, be sure to make motor fully separated from the load, and set 05-00(P.301) to 9, then press  or  on the keypad for inverter to automatically calculate following parameter: 05-16(P.317)

Note: 1. When inverter is used with different size motor, please be sure to set parameters 05-01(P.302)~05-06(P.307). Vector control relies heavily on motor parameters, so to obtain good control performance, accurate parameters of the motor controlled must be set.

2. Before executing PM motor phase Z position auto-tuning function, please first execute PM motor parameter auto-tuning function, then correctly set 09-01(P.350) and 09-02(P.351). If there is motor vibration when tuning, please decrease 11-00(P.320) value.

3. If one or more parameter values in 05-01(P.302)~05-16(P.317) have been manually modified, reset the inverter to reload the new parameter values.

### 5.6.3 Automatic measurement of motor inertia

➤ Tune the load inertia under IM/PM PG vector control.

Parameter	Name	Default	Setting Range	Content
05-17 P.318	Motor inertia	According to kW	0 ~ 6500.0kg. cm <sup>2</sup> :	5.5K and under
			0 ~ 65000kg.cm <sup>2</sup> :	7.5K~22K
05-18 P.319	Load inertia ratio	1	0~600.0	---
05-19 P.391	Inertia identification speed limit	50%	0~100%	Use motor rated rpm as 100%
05-20 P.392	Acceleration and deceleration time of inertia identification	2.0s	0 ~ 20.0s	---
05-21 P.393	Operation mode of inertia identification	1	0	0: one direction rotation
			1	1: both direction rotation

#### Setting Motor inertia auto-tuning

- ◆ Inertia automatic measurement function is only for induction motor PG vector control (00-21(P.300) = 4) or PM motor PG vector control (00-21(P.300) = 5).
- ◆ When performing inertia automatic measurement function, set 05-00(P.301) = 10, press **FWD** or **REV** on keypad, inverter will automatically calculate parameter 05-18(P.319)
- ◆ Tuning steps are as follows:

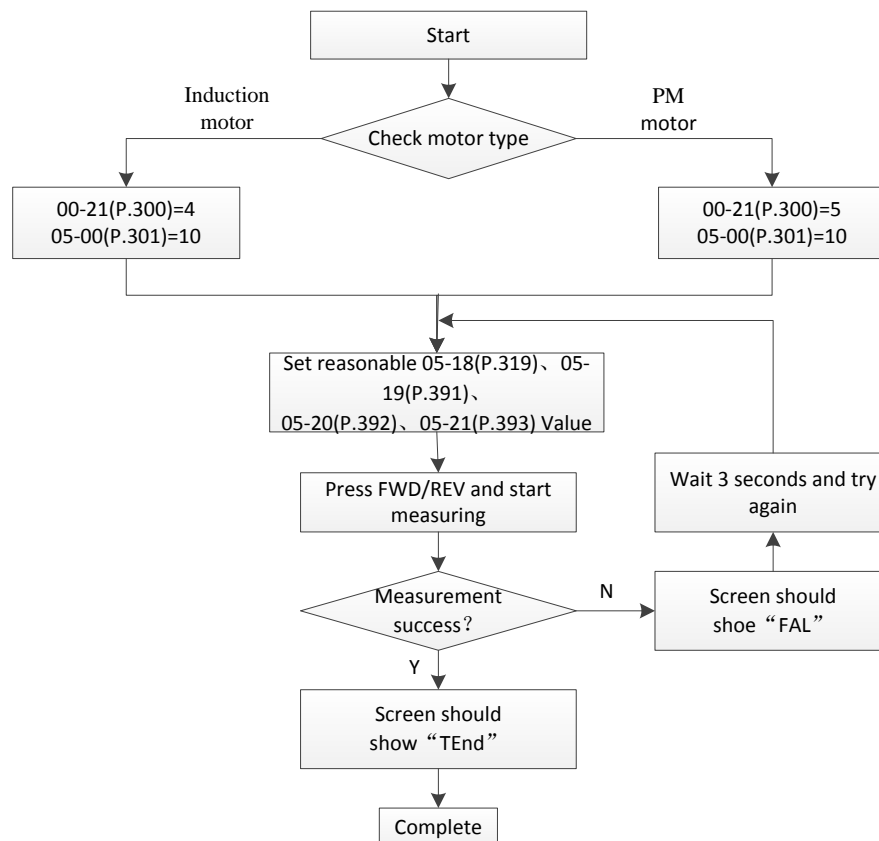

## Motor parameter group 05

- Note: 1. Before executing the IM motor inertia automatic measurement function, please follow 5.6.1 to perform the IM motor parameter automatic measurement function first, please set 00-21(P.300) = 4.
2. Before executing the PM motor inertia automatic measurement function, please perform the PM motor parameter automatic measurement function and Z-phase position automatic measurement function according to 5.6.1. Please set 00-21(P.300) = 5.
3. Before executing the automatic inertia measurement function, please set a reasonable value of 05-17(P.318) according to the inertia of the motor.
4. If the inertia measurement is abnormal, please adjust the value of 05-19(P.391) ~ 05-21(P.392) appropriately.

### 5.6.4 Second motor parameter

- By setting second motor parameter and matching digital input terminal, automatic measurement function of second motor parameters can be performed.

Parameter	Name	Default	Setting Range	Content
05-22 P.332	Second motor rated power	99999	0 ~ 650.00kW	---
			99999	Off.
05-23 P.333	Second motor poles	99999	0 ~ 48	---
			99999	Off.
05-24 P.334	Second motor rated voltage	99999	0 ~ 510V	440 Voltage
			0~255V	220 Voltage
			99999	Off.
05-25 P.335	Second motor rated frequency	99999	0 ~ 650.00Hz	---
			99999	Off.
05-26 P.336	Second motor rated current	99999	0~500.00A	---
			99999	Off.
05-27 P.337	Second motor rated rotation speed	99999	0 ~ 65000r/min	---
			99999	Off.
05-28 P.338	Second motor excitation current	99999	0~500.00A	---
			99999	Off.
05-29 P.339	Second motor (IM)stator resistance	99999	0 ~ 65000mΩ	---
			99999	Off.
05-30 P.340	Second motor (IM)rotor resistance	99999	0 ~ 65000mΩ	---
			99999	Off.
05-31 P.341	Second motor (IM)leakage inductance	99999	0 ~ 6500.0mH	---
			99999	Off.
05-32 P.342	Second motor (IM)mutual inductance	99999	0 ~ 6500.0mH	---
			99999	Off.
05-33 P.343	Second motor (PM) stator resistance	99999	0 ~ 65000mΩ:	---
			99999	Off.
05-34 P.344	Second motor (PM) d-axis inductance	99999	0 ~ 650.00mH	According to kW
			99999	Off.
05-35 P.345	Second motor (PM) q-axis inductance	99999	0 ~ 650.00mH	According to kW
			99999	Off.

Parameter	Name	Default	Setting Range	Content
05-36 P.346	Second motor (PM)	99999	0 ~ 6500.0V/krpm	According to kW
	Back-EMF coefficient		99999	Off.
05-37 P.347	Second motor (PM)	99999	0 ~ 359.9°	---
	Phase Z origin pulse compensation		99999	Off.
05-38 P.394	Second motor inertia	99999	0 ~ 6500.0kg. cm <sup>2</sup>	5.5k and below
			0 ~ 65000kg. cm <sup>2</sup>	7.5k ~ 22K model
			99999	Off.
05-39 P.395	Second motor load	99999	0~600.0	---
	inertia ratio		9999	Off.

**Setting** Second motor parameter

- ◆ When 00-22 (P. 370) ≠ 99999, RT signal is ON, second motor parameters 05-22 (P.332)~05-38 (P.395) are valid, please refer to Section 5.2.10 for second function parameter.
- ◆ For the usage of second motor parameter, please refer to 05-01 (P.302)~05-17 (P.318) motor parameter setting.

## 5.7 Protection parameter group 06

Group	Parameter Number	Name	Setting Range	Default	Page
06-00	P.9	Electronic thermal relay capacity	0~500.00A	0.00A	<u>153</u>
06-01	P.22	Stall prevention operation level	0 ~ 250.0%	150.0%	<u>154</u>
06-02	P.23	Stall prevention operation level correction factor	0 ~ 150.0% 99999: Stall prevention operation level is the setting value of 06-01(P.22).	99999	<u>154</u>
06-03	P.66	Stall prevention operation reduction starting frequency	50Hz system: 0 ~ 650.00Hz 60Hz system: 0 ~ 650.00Hz	50.00Hz 60.00Hz	<u>154</u>
06-04	P.220	Acceleration and deceleration time when current stall	X0: According to the current Acc/Dec time X1: According to the first Acc/Dec time X2: According to the second Acc/Dec time X3: Automatically calculate proper Acc/Dec time 0X: Current stall frequency reduction is invalid during acceleration/constant speed/deceleration 1X: Current stall frequency reduction is valid during constant speed 2X: Current stall frequency reduction is valid during acceleration 3X: Current stall frequency reduction is valid during acceleration and constant speed 4X: Current stall frequency reduction is valid during deceleration 5X: Current stall frequency reduction is valid during deceleration and constant speed 6X: Current stall frequency reduction is valid during acceleration and deceleration 7X: Current stall frequency reduction is valid during acceleration/constant speed/deceleration	33	<u>154</u>
06-05	P.30	Regenerative brake selection	0: Brake duty is fixed at 3%, parameter 06-06(P.70) will be off. 1: Brake duty is 06-06(P.70) value.	0	<u>156</u>
06-06	P.70	Special regenerative brake duty	0 ~ 100.0%	0.0%	<u>156</u>
06-07	P.263	Decrease carrier protection setting	0: Fixed carrier frequency, and limit output current according to carrier value. 1: Fixed rated current, and limit carrier according to output current and temperature.	0	<u>156</u>
06-08	P.155	Over torque detection level	0 ~ 200.0%	0.0%	<u>158</u>
06-09	P.156	Over torque detection time	0.1 ~ 60.0s	1.0s	<u>158</u>



Group	Parameter Number	Name	Setting Range	Default	Page
06-10	P.260	Action when detect over torque	0: OL2 alarm will not be reported after over torque detection, and inverter keeps running.	1	<a href="#">158</a>
			1: OL2 alarm will be reported after over torque detection, and inverter stops.		
06-11	P.160	Stall level when restart	0 ~ 150.0%	100.0%	<a href="#">159</a>
06-12	P.245	Cooling fan operation	0: Fan turn on when inverter starts running. Fan turn off 30 seconds after inverter stops.	0	<a href="#">159</a>
			1: Fan turn on when inverter power on. Fan turn off when inverter power off.		
			2: Fan turn on if heat sink temperature is higher than 40°C. Fan turn off when inverter power off		
			3: Fan turn on if heat sink temperature is higher than 60°C. Fan turn off when heat sink temperature is lower than 40°C.		
06-13	P.281	Input phase loss protection	0: Off	0	<a href="#">160</a>
			1: When input phase loss, inverter stops and alarms IPF.(For Frame C/D only)		
06-14	P.287	SCP Short circuit protection function	0: Off	1	<a href="#">160</a>
			1: When output side is short, inverter stops and alarms SCP.		
06-15	P.533	PTC alarm action	0: Alarm and continue to run	0	<a href="#">160</a>
			1: Alarm and decelerate to stop		
			2: Alarm and stop freely		
			3: No alarm		
06-16	P.534	Percentage of PTC level	0 ~ 100.0%	0.0%	<a href="#">160</a>
06-17	P.261	Maintenance alarm function	0: Off	0	<a href="#">161</a>
			1 ~ 9998day: Used to set the time for maintenance alarm output signal		
06-18	P.280	Short circuit to ground detection when starting	X0: When given run command to inverter, inverter does not detect short circuit to ground	10	<a href="#">161</a>
			X1: When given run command to inverter, inverter detects short circuit to ground		
			0X: When given run command to inverter, inverter does not detect short circuit between phase		
			1X: When given run command to inverter, inverter detects short circuit between phase		
06-19	P.282	GF detection level when running	0~100.0%	50.0%	<a href="#">161</a>
06-20	P.262	Output phase loss protection	0: Off	0	<a href="#">162</a>
			1: When output phase loss, inverter stops and alarms LF.		
06-21	P.705	Low voltage level	155 ~ 220V: 220V inverter type	155V	<a href="#">162</a>
			310 ~ 440V: 440V inverter type	310V	

Protection parameter group 06

Group	Parameter Number	Name	Setting Range	Default	Page
06-22	P.706	Regenerative brake operation level	205 ~ 400V: 220V inverter type	360V	<u>162</u>
			410 ~ 800V: 440V inverter type	720V	
06-23	P.707	Voltage stall level	205 ~ 400V: 220V inverter type	380V	<u>163</u>
			410 ~ 800V: 440V inverter type	760V	
06-24	P.708	Capacitor lifetime detection	0: Off 1: When the power is OFF, start to detect the lifetime of capacitor on main circuit.	0	<u>163</u>
06-25	P.709	Capacitor lifetime detection level	0 ~ 100.0%	100.0%	<u>163</u>
06-26	P.710	Capacitor lifetime detection result	0: Normal.	Read	<u>163</u>
			1: Electrolytic capacitor abnormal.		
06-27	P.292	Total inverter operation time (minutes)	0 ~ 1439 min	0 min	<u>164</u>
06-28	P.293	Total inverter operation time (days)	0 ~ 9999 day	0 day	<u>164</u>
06-29	P.296	Total inverter power on time (minutes)	0 ~ 1439 min	0 min	<u>164</u>
06-30	P.297	Total inverter power on time (days)	0 ~ 9999 day	0 day	<u>164</u>
06-31	P.298	Output power(lower 16 bit)	Read only	Read	<u>164</u>
06-32	P.299	Output power(higher 16 bit)	Read only	Read	<u>164</u>
06-40	P.288	Alarm record code query	0 ~ 12	1	<u>165</u>
06-41	P.289	Alarm record code display	Read only	Read	<u>165</u>
06-42	P.290	Alarm record message query	0 ~ 10	0	<u>165</u>
06-43	P.291	Alarm record message display	Read only	Read	<u>165</u>
06-44	P.740	E1	Read only	Read	<u>166</u>
06-45	P.741	E2	Read only	Read	<u>166</u>
06-46	P.742	E3	Read only	Read	<u>166</u>
06-47	P.743	E4	Read only	Read	<u>166</u>
06-48	P.744	E5	Read only	Read	<u>166</u>
06-49	P.745	E6	Read only	Read	<u>166</u>
06-50	P.746	E7	Read only	Read	<u>166</u>
06-51	P.747	E8	Read only	Read	<u>166</u>
06-52	P.748	E9	Read only	Read	<u>166</u>
06-53	P.749	E10	Read only	Read	<u>166</u>
06-54	P.750	E11	Read only	Read	<u>166</u>
06-55	P.751	E12	Read only	Read	<u>166</u>
06-56	P.752	Output frequency during E1 alarm	Read only	Read	<u>167</u>
06-57	P.753	Output current during E1 alarm	Read only	Read	<u>167</u>
06-58	P.754	Output voltage during E1 alarm	Read only	Read	<u>167</u>
06-59	P.755	Temperature rising accumulation rate during E1 alarm	Read only	Read	<u>167</u>
06-60	P.756	PN voltage during E1 alarm	Read only	Read	<u>167</u>

Group	Parameter Number	Name	Setting Range	Default	Page
06-61	P.757	Total inverter operation time during E1 alarm	Read only	Read	<a href="#">167</a>
06-62	P.758	Inverter operation status code during E1 alarm	Read only	Read	<a href="#">167</a>
06-63	P.759	E1 alarm date (years / months)	Read only	Read	<a href="#">167</a>
06-64	P.760	E1 alarm date (days/hours)	Read only	Read	<a href="#">167</a>
06-65	P.761	E1 alarm date (minutes / seconds)	Read only	Read	<a href="#">167</a>
06-70	P.766	Output frequency during E2 alarm	Read only	Read	<a href="#">167</a>
06-71	P.767	Output current during E2 alarm	Read only	Read	<a href="#">167</a>
06-72	P.768	Output voltage during E2 alarm	Read only	Read	<a href="#">167</a>
06-73	P.769	Temperature rising accumulation rate during E2 alarm	Read only	Read	<a href="#">167</a>
06-74	P.770	PN voltage during E2 alarm	Read only	Read	<a href="#">167</a>
06-75	P.771	Total inverter operation time during E2 alarm	Read only	Read	<a href="#">167</a>
06-76	P.772	Inverter operation status code during E2 alarm	Read only	Read	<a href="#">167</a>
06-77	P.773	E2 alarm date (years / months)	Read only	Read	<a href="#">167</a>
06-78	P.774	E2 alarm date (days/hours)	Read only	Read	<a href="#">167</a>
06-79	P.775	E2 alarm date (minutes / seconds)	Read only	Read	<a href="#">167</a>

### 5.7.1 Electronic thermal relay capacity

- “Electronic thermal relay” uses inverter computing power to simulate a thermal relay for preventing motor from overheating.

Parameter	Name	Default	Setting Range	Content
06-00 P.9	Electronic thermal relay capacity	0.00A	0~500.00A	---

Setting Electronic thermal relay capacity

- ◆ Please set the value of 06-00(P.9) as the rated current value of the motor at the rated frequency. Rated frequencies of squirrel cage induction motors manufactured in different countries and regions are different. Please refer to the motor nameplate for specific data.
- ◆ If 06-00(P.9)=0, electronic thermal relay is off.
- ◆ When the electronic thermal relay calculates that the motor has accumulated too much heat, the keypad will display a fault code **F H N** and the output will stop.

Note: 1. After the inverter is reset, the heat accumulation record of the electronic thermal relay will return to zero, this should be paid attention to during use.  
 2. If two or more motors are connected to the inverter, the electronic thermal relay cannot be used as overheat protection for the motors. Please install external thermal relay on each motor.  
 3. When special motors are used, electronic thermal relay cannot be used for protection. Please install external thermal relay on the motor.  
 4. Please refer to **03-00~03-05(P.80~P.84, P.86)** for the use and wiring method of thermal relay.

## 5.7.2 Current stalling protection

- In order to avoid the alarm and stop of the inverter due to overcurrent and overvoltage, the output current is monitored to automatically change the output frequency. It can realize stall prevention during acceleration and deceleration process or during electric regeneration, and make high response current limit valid.

Parameter	Name	Default	Setting Range	Content
06-01 P.22	Stall prevention operation level	150.0%	0 ~ 250.0%	---
06-02 P.23	Stall prevention operation level correction factor	99999	0 ~ 150.0%	---
			99999	Stall prevention operation level is the setting value of 06-01(P.22).
06-03 P.66	Stall prevention operation reduction starting frequency	50.00Hz	0 ~ 650.00Hz	50Hz system(00-24(P.189)=1): 0 ~ 650.00Hz
		60.00Hz		60Hz system(00-24(P.189)=0): 0 ~ 650.00Hz
06-04 P.220	Acceleration and deceleration time when current stall	33	X0	According to the current Acc/Dec time
			X1	According to the first Acc/Dec time
			X2	According to the second Acc/Dec time
			X3	Automatically calculate proper Acc/Dec time
			0X	Current stall frequency reduction is invalid during acceleration/constant speed/deceleration
			1X	Current stall frequency reduction is valid during constant speed
			2X	Current stall frequency reduction is valid during acceleration
			3X	Current stall frequency reduction is valid during acceleration and constant speed
			4X	Current stall frequency reduction is valid during deceleration
			5X	Current stall frequency reduction is valid during deceleration and constant speed
			6X	Current stall frequency reduction is valid during acceleration and deceleration
7X	Current stall frequency reduction is valid during acceleration/constant speed/deceleration			

 Setting Current stalling protection

- ◆ When heavy load and motor starts or target frequency changes (increases), the rotating speed of motor often cannot keep up with the speed of output frequency change. When the rotation speed of motor is lower than output frequency, output current will increase to enhance output torque. However, if the difference between output frequency and motor speed is too large, motor torque will be reduced, which is called “stall”

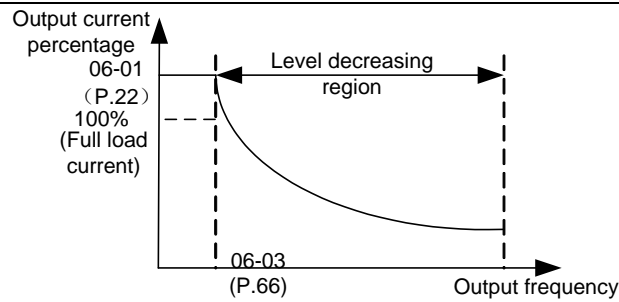

Formula for stall prevention level:

$$\text{Level percentage} = A + B \times \frac{06-01(P.22) - A}{06-01(P.22) - B} \times \frac{06-02(P.23) - 100}{100}$$

$$A = \frac{(06-23(P.66)) \times (06-01(P.22))}{\text{Output frequency}} \quad B = \frac{(06-23(P.66)) \times (06-01(P.22))}{400}$$

- ◆ When load is heavy, the output current of inverter will increase. Once the percentage of output current exceeds curve shown in the diagram below, inverter will reduce output frequency according to deceleration time selected in 06-04(P.220). After rotation speed of motor keeps up (output current of inverter will decrease accordingly), inverter will accelerate and recover to original output frequency (output frequency at stall) according to acceleration time selected in 06-04(P.220), and then continue to increase output frequency.

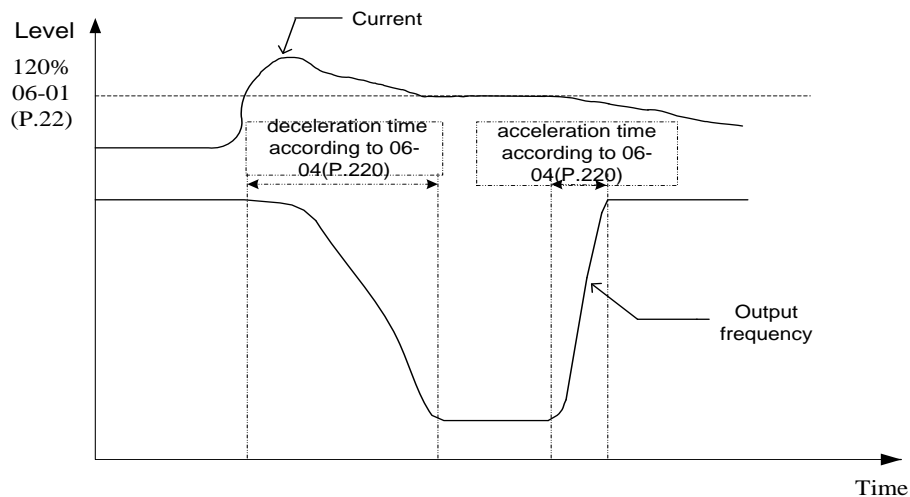

Current in the figure refers to the current amplitude

Note: 1. If set 00-21(P.300) to 3 sensorless vector control, 06-01(P.22) will act as torque limit level operation.  
 2. When 06-04(P.220)=2, if 01-22(P.44) is not set, acceleration time will be 01-07(P.8); if 01-23(P.45) is not set, deceleration time will be 01-07(P.8).

### 5.7.3 Regenerative brake

- When performing frequent start and stop operation, regenerative brake usage rate can be increased by using the brake resistor or the brake unit.

Parameter	Name	Default	Setting Range	Content
06-05 P.30	Regenerative brake selection	0	0	Brake duty is fixed at 3%, parameter 06-06(P.70) will be off.
			1	Brake duty is 06-06(P.70) value.
06-06 P.70	Special regenerative brake duty	0.0%	0 ~ 100.0%	---

#### Setting Regenerative brake

- ◆ During the period when output frequency of inverter changes from high frequency to low frequency, due to load inertia, the rotating speed of the motor is higher than the output frequency of inverter at an instant, thus forming the generator effect. This will cause regenerative voltage between main circuit terminals (+/P)-(-/N), which may result in damage to inverter. Therefore, a regenerative braking resistor with an appropriate size is installed between main circuit terminals +/P and PR to absorb the feedback energy.
- ◆ There is a transistor in inverter and the proportion of conduction time is called "regenerative braking rate". The greater the value of regenerative braking rate, the more energy regenerative braking resistor consumes and the stronger the braking capability.

Note: 1. If inverter is used in high-frequency start/stop case, it need a high-power regenerative braking resistor.  
2. Please refer to [section 3.6.3 Regenerative braking resistor](#).

### 5.7.4 Decrease carrier protection setting

- It selects decrease carrier or decrease rated current protection by setting parameters.

Parameter	Name	Default	Setting Range	Content
06-07 P.263	Decrease carrier protection setting	0	0	Fixed carrier frequency, and limit output current according to carrier value.
			1	Fixed rated current, and limit carrier according to output current and temperature.

#### Setting Decrease carrier protection

- ◆ 06-07(P.263)=0, fixed carrier frequency, but the rated current of inverter will be reduced according to set carrier frequency and corresponding curve, so as to avoid overheating of IGBT module on inverter:

**440V type heavy duty (HD)**

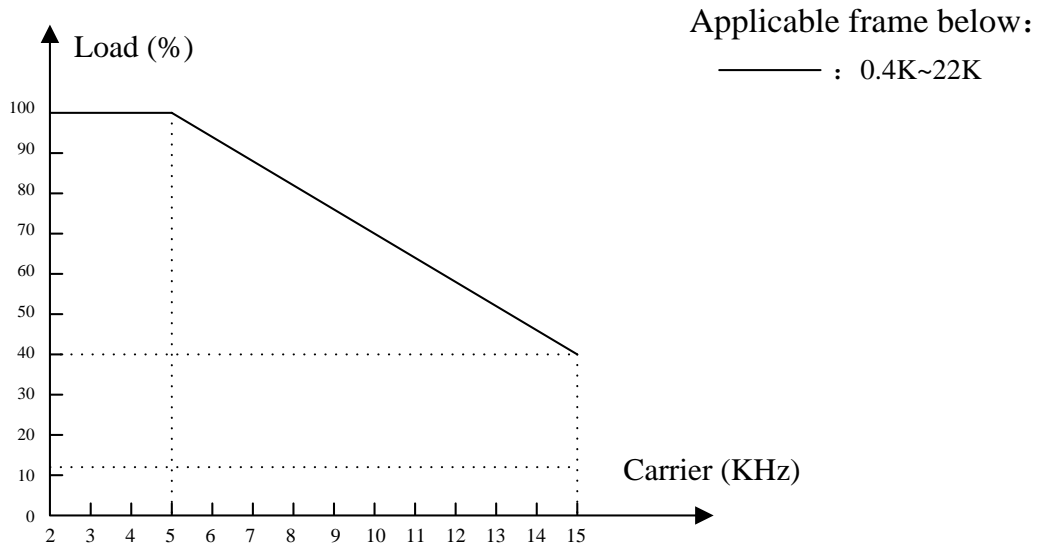

**440V type normal duty (ND)**

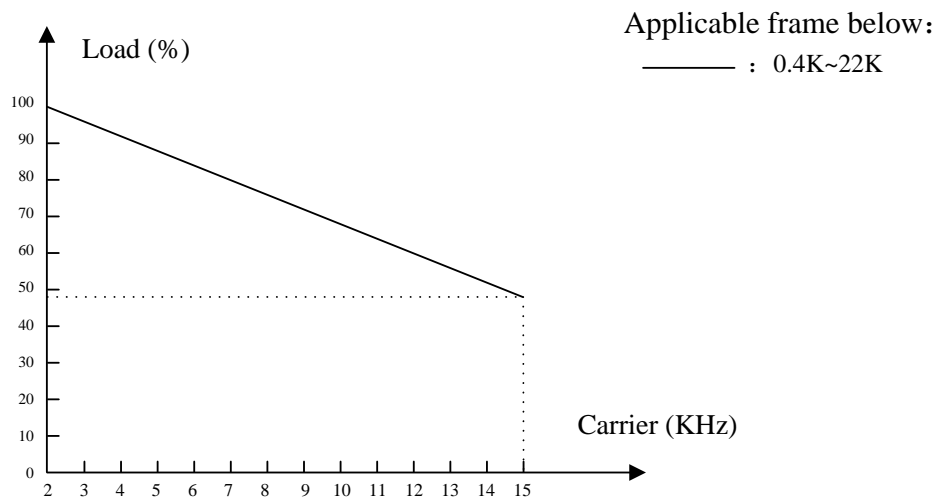

**220V type heavy duty (HD)**

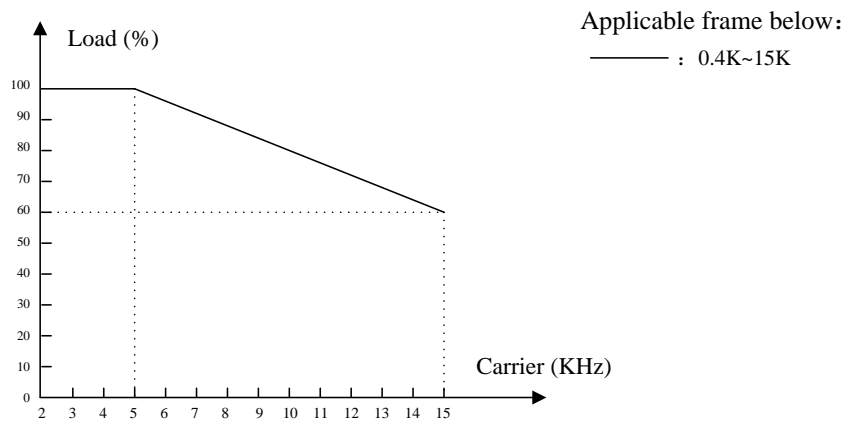

**220V type normal duty (ND)**

Applicable frame below:

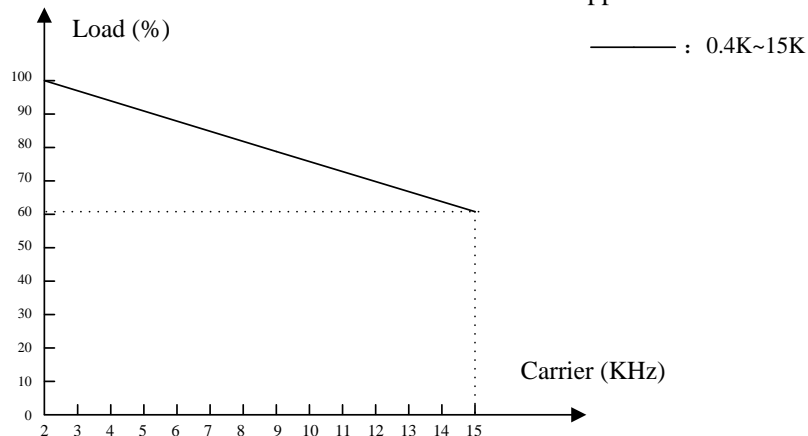

- ◆ 06-07(P.263)=1, fixed rated current, inverter will automatically reduce operating carrier frequency according to IGBT module temperature to avoid overheating of IGBT module.

Rules are as follows: when IGBT module temperature is over 80°C, automatically decrease carrier frequency to the carrier value when the duty is 100% shown as the figure above; when the temperature is lower than 70°C, operating carrier will automatically increase to set value of 00-11(P.72).

**5.7.5 Over torque detection**

- Output current detection function can be used for over torque detection.

Parameter	Name	Default	Setting Range	Content
06-08 P.155	Over torque detection level	0.0%	0	No over torque detection.
			0.1~200%	Over torque detection.
06-09 P.156	Over torque detection time	1.0s	0.1 ~ 60.0s	---
06-10 P.260	Action when detect over torque	1	0	OL2 alarm will not be reported after over torque detection, and inverter keeps running.
			1	OL2 alarm will be reported after over torque detection, and inverter stops.

**Setting** Over torque detection

- ◆ If set value of 06-08(P.155) is not zero, over-torque detection function is on.
- ◆ If output current exceeds over-torque detection level (06-08(P.155)) and over-torque detection time (06-09(P.156)), inverter will trigger OL2 alarm and stop. If digital output terminals SO-SE (03-10(P.40)), relay A-B-C(03-11(P.85)) are set to over-torque alarm (set value is 19), inverter will output a signal. If digital output terminals SO-SE (03-10(P.40)), relay A-B-C (03-11(P.85)) are set to over-load alarm (set value is 3), and 06-10 (P.260) =1, inverter will output a signal. Please refer to section 5.4.2 Digital output function selection



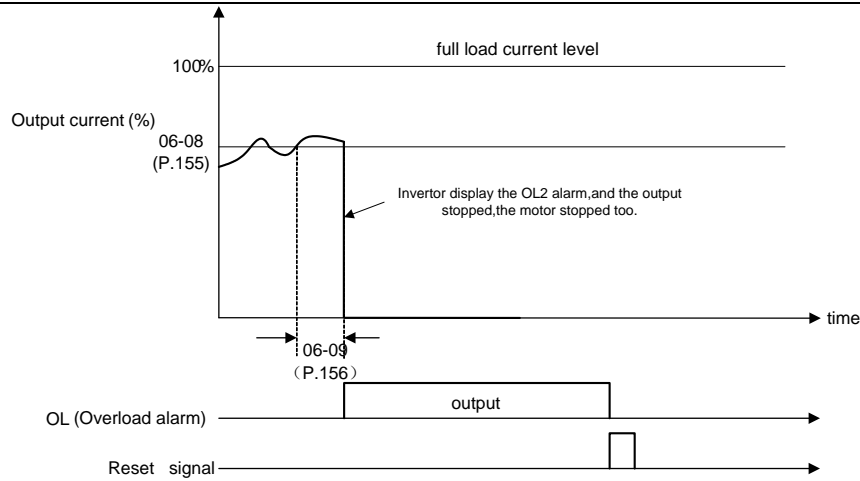

### 5.7.6 Stall level when restart

➤ It can set stall prevention level when inverter restart through 06-11(P.160).

Parameter	Name	Default	Setting Range	Content
06-11 P.160	Stall level when restart	100.0%	0 ~ 150.0%	When restarting, stall prevention operation level.

Setting Stall level when restart

◆ In restart process, if output current of inverter is higher than set value of 06-11 (P.160), inverter will be in a current stall state.

### 5.7.7 Cooling fan operation

➤ Control run/stop condition of fan and alarm output mode through parameter setting..

Parameter	Name	Default	Setting Range	Content
06-12 P.245	Cooling fan operation	0	0	Fan turn on when inverter starts running. Fan turn off 30 seconds after inverter stops.
			1	Fan turn on when inverter power on. Fan turn off when inverter power off.
			2	Fan turn on if heat sink temperature is higher than 40°C. Fan turn off when inverter power off
			3	Fan turn on if heat sink temperature is higher than 60°C. Fan turn off when heat sink temperature is lower than 40°C.

Settin Cooling fan operation

◆ Each value in 06-12(P.245) is used to specify run/stop condition.

Ex: If user need fan turn on when inverter power on, fan turn off when inverter power off, set 06-12(P.245)=1.

Note: According to the installation environment conditions of inverter, if fan can be operated for as little time as possible through reasonable setting, service life of fan can be prolonged.

## 5.7.8 Input phase loss protection

- Turn on input phase failure protection.

Parameter	Name	Default	Setting Range	Content
06-13 P.281	Input phase loss protection	0	0	Off
			1	When input phase loss, inverter stops and alarms IPF (for frame C/D only)

 Input phase loss protection

- ◆ When 06-13(P.281)=1, input phase loss protection is on; when input power is out of phase or three phases are imbalance, inverter will trigger alarm IPF. Frame A/B are not equipped with IPF function.

## 5.7.9 Output short circuit protection function

- Turn on output short circuit protection function.

Parameter	Name	Default	Setting Range	Content
06-14 P.287	SCP Short circuit protection function	1	0	Off
			1	When output side is short, inverter stops and alarms SCP.

 Output Short circuit protection function

- ◆ If 06-14(P.287) is set to 0, output side short circuit protection function will be off.
- ◆ If 06-14(P.287)=1, output short circuit protection is on, and when a short circuit on the output side is detected, inverter “SCP” alarm will trigger.

## 5.7.10 PTC protection selection

- Set how inverter will operate after PTC detection.

Parameter	Name	Default	Setting Range	Content
06-15 P.533	PTC alarm action	0	0	Alarm and continue to run
			1	Alarm and decelerate to stop
			2	Alarm and stop freely
			3	No alarm
06-16 P.534	Percentage of PTC level	0.0%	0	Off
			0.1%~100.0%	Action level of PTC function, 100% corresponds to maximum analog input.

 PTC level

- ◆ Set analog input terminal 2-5/4-5 (02-00(P.500)/02-01(P.501)) to 11 (positive temperature coefficient thermistor (PTC) input value). This parameter is defined as action level of PTC function, and 100% corresponds to maximum analog input value

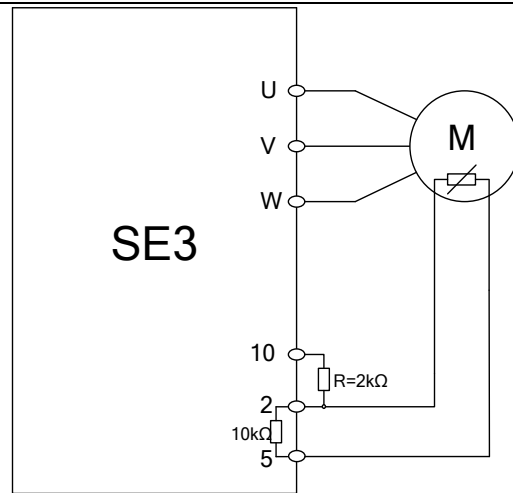

PTC Electronic input wiring diagram

### 5.7.11 Maintenance alarm function

- Inverter counts operation time and trigger maintenance alarm output signal after time set.

Parameter	Name	Default	Setting Range	Content
06-17 P.261	Maintenance alarm function	0	0	Off
			1 ~ 9998day	Used to set the time for maintenance alarm output signal

#### Setting Maintenance alarm function

- ◆ If digital output terminal (03-10(P.40),03-11(P.85)) is set to 18, it is the maintenance alarm function. If the frequency converter runs for a number of days and reaches the set value of maintenance alarm time parameter 06-17(P.261), the multi-function digital output terminal of the frequency converter will output signals.

### 5.7.12 Short circuit to ground protection

- Set inverter detects short circuit to ground and detection level

Parameter	Name	Default	Setting Range	Content
06-18 P.280	Short circuit to ground detection when starting	10	X0	When given run command to inverter, inverter does not detect short circuit to ground
			X1	When given run command to inverter, inverter detects short circuit to ground
			0X	When given run command to inverter, inverter does not detect short circuit between phase
			1X	When given run command to inverter, inverter detects short circuit between phase
06-19 P.282	GF detection level when running	50.0%	0~100%	22K and types below
		70.0%		

#### Setting Short circuit to ground

- ◆ Short circuit to ground detection when starting is on when start command is given to inverter.
- ◆ The single digit part of 06-18(P.280) is used to set whether check short to ground when start, 06-19(P.282) is used to set when operation.

## Protection parameter group 06

- ◆ The double digit part of 06-18(P.280) is used to set whether check short between phase when start
- ◆ If short to ground detection is set and output short-circuited current exceeds 50% of rated current when start, inverter will stop outputting and trigger GF alarm.
- ◆ During operation, output short-circuited current exceeds set value of 06-19(P.282) % rated current, inverter will stop outputting and trigger GF alarm.

### 5.7.13 Output phase loss protection

- Turn on output phase loss protection function..

Parameter	Name	Default	Setting Range	Content
06-20 P.262	Output phase loss protection	0	0	Off
			1	When output phase loss, inverter stops and alarms LF.

**Setting** Output phase loss protection

- ◆ 06-20(P.262)="1", When output phase loss, inverter stops and alarms LF; when 06-20(P.262)="0", the function will be off.

### 5.7.14 Low voltage protection

- Control the low voltage level by parameter.

Parameter	Name	Default	Setting Range	Content
06-21 P.705	Low voltage level	155V	155 ~ 220V	220V type
		310V	310 ~ 440V	440V type

**Setting** Low voltage level

- ◆ When inverter input voltage is too low, which leads to the DC bus voltage lower than 06-21(P.705) value, inverter enters low voltage protection state, it will stop output and idle stop.

### 5.7.15 Regenerative brake operation level

- Set regenerative brake operation level by parameter.

Parameter	Name	Default	Setting Range	Content
06-22 P.706	Regenerative brake operation level	360V	205 ~ 400V	220V
		720V	410 ~ 800V	440V

**Setting** Regenerative brake operation level

- ◆ 06-22(P.706) is regenerative brake (brake resistor) operation level. When DC (PN) bus voltage is over 06-22(P.706) value, regenerative brake (brake resistor) operation starts.

### 5.7.16 Voltage stall level

- Set voltage stall operation level.

Parameter	Name	Default	Setting Range	Content
06-23 P.707	Voltage stall level	380V	205 ~ 400V	220V type
		760V	410 ~ 800V	440V type

Setting Voltage stall level

- ◆ When inverter output voltage is over 06-23(P.707) set value, it is in voltage stall state.

### 5.7.17 Capacitor lifetime detection

- Capacitors on main circuit may age and its capacity may reduce. This function is to detect capacitor service life in main circuit and serve as a replacement standard.

Parameter	Name	Default	Setting Range	Content
06-24 P.708	Capacitor lifetime detection	0	0,1 (3, 7, 8, 9)	0: Off 1: When power is OFF, start to detect the lifetime of capacitor on main circuit. After detection is finished and power on this parameter value will change to 3.
06-25 P.709	Capacitor lifetime detection level	100.0%	0 ~ 100.0%	Percentage of detection capacitance value and factory detection value
06-26 P.710	Capacitor lifetime detection result	Read	0	Normal.
			1	Electrolytic capacitor abnormal.(less than 80% capacity compared to test in factory)

Setting Capacitor lifetime detection

- ◆ Detect the aging degree of the capacitance of the main circuit..

06-24(P.708)	Content	Remarks
0	No capacitor lifetime detection.	Initial value.
1	Start to detect.	When the power is OFF, start to detect the lifetime of capacitor on main circuit.
3	Capacitor lifetime detection is finished.	Read only
7	Control mode is not correct cannot detected ( Not in V/F mode )	
8	detection process is forced to end ( B , F , H )	
9	An error occurs during the detection process ( A , C , G , E )	

Detection percentage of capacitance life 06-25(P.709) is theoretical calculation result and can only be used as a reference.

Capacitance tested in factory is 100.0%, if detection result 06-25(P.709) is less than 80%, then 06-26(P.710)="1". Digital output terminals can also output alarm signal (set 03-10(P.40), 03-11(P.85) to 20)

- ◆ Detection steps are as follows:

1. Check motor is connected.
2. When inverter is stop set 06-24(P.708) to 1 and cut off the power.
3. Inverter applies DC voltage to motor to measure capacitor capacity while inverter is OFF.
4. After power indicator is OFF, turn ON the power again.
5. Check that "3" is written in 06-24(P.708), read 06-25(P.709) to check aging degree of the main circuit capacitor.

## Protection parameter group 06

- ◆ Capacitance lifetime cannot be detected under the following conditions.
  1. Terminals P/N is connected to DC power supply.
  2. Power supply is switched ON during measurement.
  3. Motor is not connected to inverter.
  4. Motor is running (coasting).
  5. Alarm occurs during capacitance detection process
  6. Inverter output is shut off by MRS signal.
  7. Motor capacity is two level or more smaller than inverter.
  8. Start command is given while measuring.

Note: 1. Considering capacitor temperature will affects capacity; please wait three hours or longer after power OFF before testing.

2. Capacitor lifetime detection can only be operated under V/F mode.

3. Frame A /B are not equipped with capacitor lifetime detection function.

### 5.7.18 Time record function

- It is used to record the inverter accumulative operation time.

Parameter	Name	Default	Setting Range	Content
06-27 P.292	Total inverter operation time (minutes)	0 min	0 ~ 1439min	---
06-28 P.293	Total inverter operation time (days)	0 day	0 ~ 9999day	---
06-29 P.296	Total inverter power on time (minutes)	0 min	0 ~ 1439min	---
06-30 P.297	Total inverter power on time (days)	0day	0 ~ 9999day	---

Setting Time record function

- ◆ 06-27(P.292) is operation minutes of the inverter. The value cannot be changed when 00-02=3(P.998=1) is executed or power is cut off, but can be cleared when set 06-27(P.292) to 0.
- ◆ 06-28(P.293) is operation days of the inverter. The value cannot be changed when 00-02=3(P.998=1) is executed or power is cut off, but can be cleared when set 06-28(P.293) to 0.

### 5.7.19 Output power calculation

Parameter	Name	Default	Setting Range	Content
06-31 P.298	Output power (lower 16 bits)	Read only	Read only	There are two decimals, read only and can be written to 0
06-32 P.299	Output power (higher 16 bits)	Read only	Read only	Read only and can be written to 0

- ◆ Output power value= $06-32(\text{P.299}) \times 2^{16} + 06-31(\text{P.298})$ , and unit is kWh.

## 5.7.20 Alarm query function

➤ This function provides users with information about latest 12 alarm codes.

Parameter	Name	Default	Setting Range	Content	
06-40 P.288	Alarm record code query	1	0 ~ 12	06-40 (P.288) value 1~12 corresponds to 06-41(P.289)'s alarm E1~E12.	
06-41 P.289	Alarm record code display	Read only	Read only		
06-42 P.290	Alarm record message query	0	0 ~ 10	Alarm message of No. 06-40 (P.288) 06-42 (P.290) =1, 06-43 (P.291) displays frequency when 06-40 (P.288) alarm. 06-42 (P.290) =2, 06-43 (P.291) displays current when 06-40 (P.288) alarm. 06-42 (P.290) =3, 06-43 (P.291) displays output voltage when 06-40 (P.288) alarm. 06-42 (P.290) =4, 06-43 (P.291) displays temperature rising accumulation rate when 06-40 (P.288) alarm. 06-42 (P.290) =5, 06-43 (P.291) displays PN voltage when 06-40 (P.288) alarm. 06-42 (P.290) =6, 06-43 (P.291) displays total inverter operation time when 06-40 (P.288) alarm. 06-42 (P.290) =7, 06-43 (P.291) displays inverter operation status code when 06-40 (P.288) alarm. 06-42 (P.290) =8, 06-43 (P.291) displays dates (years and months) when 06-40 (P.288) alarm. 06-42 (P.290) =9, 06-43 (P.291) displays dates (days and hours) when 06-40 (P.288) alarm. 06-42 (P.290) =10, 06-43 (P.291) displays dates (minutes and seconds) when 06-40 (P.288) alarm.	
06-43 P.291	Alarm record message display	Read only	Read only		

Setting

Alarm query function

- ◆ User can read this parameter to know previous 12 alarms and their corresponding information such as frequency, current and voltage. Alarm number recorded by this parameter and status information when alarm occurs will be cleared if perform **00-02=1(P.996=1)** operation.
- ◆ If parameters 06-40(P.288) and 06-42(P.290) are both 0, 06-41(P.289) and 06-43(P.291) will also display 0.
- ◆ 06-41 (P.290) and 06-43 (P.291) will only work if 06-40 (P.288) has been set. For example, if 06-40 (P.288) =3, 06-41(P.290) =2 is set, then 06-42 (P.289) displays alarm number of alarm E3 and 06-43 (P.291) displays current value of alarm E3.

## Protection parameter group 06

Alarm number corresponded alarm condition:

Abnormal code	Alarm type	Abnormal code	Alarm type	Abnormal code	Alarm type	Abnormal code	Alarm type	Abnormal code	Alarm type
00	No alarm	35	OV0	85	HDC	161	PUE	210	PG2
16	OC1	48	THT	86	ADE	162	CbE	211	PG3
17	OC2	49	THN	97	OLS	179	SCP	212	bEb
18	OC3	50	NTC	98	OL2	192	CPU	213	PTC
19	OC0	64	EEP	128	GF	193	CPR	214	dv4
32	OV1	66	PID	129	AEr	195	EbE1	215	dv3
33	OV2	82	IPF	144	OHT	208	PG0	216	dv1
34	OV3	84	LF	160	OPT	209	PG1	217	dv2

Note: If PU302 is used, these functions will not work: 06-42(P.290) =8, 9, 10. Select 06-43 (P.291) to display years/months, days/hours, minutes/seconds when alarm occurs.

### 5.7.21 Alarm code query

➤ Used to monitor latest 12 alarm codes.

Parameter	Name	Default	Setting Range	Content
06-44 P.740	The first (the latest) alarm code E1	Read only	Read only	---
06-45 P.741	The second alarm code E2	Read only	Read only	---
06-46 P.742	The third alarm code E3	Read only	Read only	---
06-47 P.743	The fourth alarm code E4	Read only	Read only	---
06-48 P.744	The fifth alarm code E5	Read only	Read only	---
06-49 P.745	The sixth alarm code E6	Read only	Read only	---
06-50 P.746	The seventh alarm code E7	Read only	Read only	---
06-51 P.747	The eighth alarm code E8	Read only	Read only	---
06-52 P.748	The ninth alarm code E9	Read only	Read only	---
06-53 P.749	The tenth alarm code E10	Read only	Read only	---
06-54 P.750	The eleventh alarm code E11	Read only	Read only	---
06-55 P.751	The twelve alarm code E12	Read only	Read only	---

Setting Alarm code

◆ For the alarm corresponded alarm code, please refer to Section [5.7.20 Alarm query function](#)



### 5.7.22 Latest alarm message (E1)

- It can record details of the latest failure and analyze whether there is any abnormal condition in inverter.

Parameter	Name	Default	Setting Range	Content
06-56 P.752	Output frequency during E1 alarm	Read only	Read only	---
06-57 P.753	Output current during E1 alarm	Read only	Read only	---
06-58 P.754	Output voltage during E1 alarm	Read only	Read only	---
06-59 P.755	Temperature rising accumulation rate during E1 alarm	Read only	Read only	---
06-60 P.756	PN voltage during E1 alarm	Read only	Read only	---
06-61 P.757	Total inverter operation time during E1 alarm	Read only	Read only	---
06-62 P.758	Inverter operation status code during E1 alarm	Read only	Read only	---
06-63 P.759	E1 alarm date (years / months)	Read only	Read only	---
06-64 P.760	E1 alarm date (days/hours)	Read only	Read only	---
06-65 P.761	E1 alarm date (minutes / seconds)	Read only	Read only	---

Note: If PU302 is used, these functions will not work: Set 06-63(P.759) ~06-65(P.761) to display years/months, days/hours, minutes/seconds when alarm occurs.

### 5.7.23 The second alarm message (E2)

- It can record details of the second failure and analyze whether there is any abnormal condition in inverter.

Parameter	Name	Default	Setting Range	Content
06-70 P.766	Output frequency during E2 alarm	Read only	Read only	---
06-71 P.767	Output current during E2 alarm	Read only	Read only	---
06-72 P.768	Output voltage during E2 alarm	Read only	Read only	---
06-73 P.769	Temperature rising accumulation rate during E2 alarm	Read only	Read only	---
06-74 P.770	PN voltage during E2 alarm	Read only	Read only	---
06-75 P.771	Total inverter operation time during E2 alarm	Read only	Read only	---
06-76 P.772	Inverter operation status code during E2 alarm	Read only	Read only	---
06-77 P.773	E2 alarm date (years / months)	Read only	Read only	---
06-78 P.774	E2 alarm date (days/hours)	Read only	Read only	---
06-79 P.775	E2 alarm date (minutes / seconds)	Read only	Read only	---

Note: If PU302 is used, these functions will not work: Set 06-77(P.773)~06-79(P.775) to display years/months, days/hours, minutes/seconds when alarm occurs.

## 5.8 Communication parameter group 07

Group	Parameter Number	Name	Setting Range	Default	Page
07-00	P.33	COM1 Communication protocol selection	0: Modbus protocol	1	<a href="#">171</a>
			1: Shihlin protocol		
			2 : PLC protocol ( Effective when using Shihlin built-in PLC )		
07-01	P.36	COM1 inverter communication station number	0 ~ 254	0	<a href="#">171</a>
07-02	P.32	COM1 Serial communication baud rate	0: Baud rate:4800bps	1	<a href="#">171</a>
			1: Baud rate:9600bps		
			2: Baud rate:19200bps		
			3: Baud rate:38400bps		
			4: Baud rate:57600bps		
			5: Baud rate:115200bps		
07-03	P.48	COM1 data length	0: 8bit	0	<a href="#">171</a>
			1: 7bit		
07-04	P.49	COM1 stop bit length	0: 1bit	0	<a href="#">171</a>
			1: 2bit		
07-05	P.50	COM1 parity check selection	0: No parity check	0	<a href="#">171</a>
			1: Odd		
			2: Even		
07-06	P.51	COM1 CR/LF selection	1: CR only	1	<a href="#">171</a>
			2: Both CR and LF		
07-07	P.154	COM1 Modbus communication format	0: 1, 7, N, 2 (Modbus, ASCII)	4	<a href="#">171</a>
			1: 1, 7, E, 1 (Modbus, ASCII)		
			2: 1, 7, O, 1 (Modbus, ASCII)		
			3: 1, 8, N, 2 (Modbus, RTU)		
			4: 1, 8, E, 1 (Modbus, RTU)		
			5: 1, 8, O, 1 (Modbus, RTU)		
07-08	P.52	COM1 Number of communication retries	0 ~ 10	1	<a href="#">171</a>
07-09	P.53	COM1 communication interval allowed time	0~999.8s: Checking communication timeout with the set value	99999	<a href="#">171</a>
			99999: No timeout check		
07-10	P.153	COM1 communication alarm action	0: Alarm and stop freely	1	<a href="#">171</a>
			1: No alarm and continuing to operation		
07-11	P.34	Communication EEPROM write-in selection	0: When writing parameters in communication mode, write in RAM and EEPROM	0	<a href="#">187</a>
			1: When writing parameters through communication, only write into RAM		
07-15	P.800	CANopen slave address	0 ~ 127	0	<a href="#">188</a>
07-16	P.801	CANopen rate	0: 1Mbps	0	<a href="#">188</a>
			1: 500Kbps		
			2: 250K/280Kbps		

Group	Parameter Number	Name	Setting Range	Default	Page
07-16	P.801	CANopen rate	3: 125Kbps	0	<u>188</u>
			4: 100Kbps		
			5: 50 Kbps		
07-17	P.802	CANopen communication status	0: Node retry status	0	<u>188</u>
			1: Communication retry status		
			2: Retry completion status		
			4: stop state		
			5: operation status		
			127: pre-operational status		
07-18	P.803	CANopen control status	0: Boot not completed status	0	<u>188</u>
			1: Forbidden operation state		
			2: Pre-excitation status		
			3: Excitation state		
			4: Allowed operating status		
			7: Quick action stop status		
			13: Trigger error action status		
			14: Error status		
07-25	P.810	PU communication protocol selection	0: Modbus protocol	1	<u>171</u>
			1: Shihlin protocol		
			2: PLC protocol (Effective when using Shihlin built-in PLC)		
07-26	P.811	PU inverter communication station number	0~254	0	<u>171</u>
07-27	P.812	PU Serial communication baud rate	0 : Baud rate 4800bps	1	<u>172</u>
			1 : Baud rate 9600bps		
			2 : Baud rate 19200bps		
			3 : Baud rate 38400bps		
			4 : Baud rate 57600bps		
			5 : Baud rate 115200bps		
07-28	P.813	PU data length	0 : 8bit	0	<u>172</u>
			1 : 7bit		
07-29	P.814	PU stop bit	0 : 1bit	0	<u>172</u>
			1 : 2bit		
07-30	P.815	PU Parity check option	0 : no parity check	0	<u>172</u>
			1 : odd check		
			2 : even check		
07-31	P.816	PU CR/LF selection	1: CR only	1	<u>172</u>
			2: Both CR and LF		
07-32	P.817	PU Modbus communication format	0 : 1、7、N、2 (Modbus, ASCII)	4	<u>172</u>
			1 : 1、7、E、1 (Modbus, ASCII)		
			2 : 1、7、O、1 (Modbus, ASCII)		
			3 : 1、8、N、2 (Modbus, RTU)		
			4 : 1、8、E、1 (Modbus, RTU)		
			5 : 1、8、O、1 (Modbus, RTU)		

Communication parameter group 07

Group	Parameter Number	Name	Setting Range	Default	Page
07-33	P.818	PU Number of communication retries	0 ~ 10	1	<a href="#">172</a>
07-34	P.819	PU communication interval allowed time	0~999.8s: Check communication timeout with the set value	99999	<a href="#">172</a>
			99999: Off		
07-35	P.820	PU communication error handling	0: Alarm and stop freely.	1	<a href="#">172</a>
			1: No alarm and continue running		
07-41	P.826	Expansion communication card number of communication retries	0~10	1	<a href="#">172</a>
07-42	P.827	Expansion communication card communication error handling	0: Alarm and idling and stopping	1	<a href="#">172</a>
			1: No alarm and continue running		
07-43	P.828	Expansion communication card communication interval allowed time	0~999.8s: Check communication timeout with the set value	99999	<a href="#">172</a>
			99999: Off		
07-44	P.829	Version of EP301 communication card	Read only	read	<a href="#">188</a>
07-45	P.830	IP configuration	0: Static IP	0	<a href="#">189</a>
			1: Dynamic IP		
07-46	P.831	IP address 1	0~255	192	<a href="#">189</a>
07-47	P.832	IP address 2	0~255	168	<a href="#">189</a>
07-48	P.833	IP address 3	0~255	2	<a href="#">189</a>
07-49	P.834	IP address 4	0~255	102	<a href="#">189</a>
07-50	P.835	Subnet mask 1	0~255	255	<a href="#">189</a>
07-51	P.836	Subnet mask 2	0~255	255	<a href="#">189</a>
07-52	P.837	Subnet mask 3	0~255	255	<a href="#">189</a>
07-53	P.838	Subnet mask 4	0~255	0	<a href="#">189</a>
07-54	P.839	Default gateway 1	0~255	192	<a href="#">189</a>
07-55	P.840	Default gateway 2	0~255	168	<a href="#">189</a>
07-56	P.841	Default gateway 3	0~255	2	<a href="#">189</a>
07-57	P.842	Default gateway 4	0~255	100	<a href="#">189</a>

## 5.8.1 Shihlin protocol and Modbus protocol

- These protocols can link and communicate with upper controller through **RS485** communication port of inverter for parameter setting, monitoring, etc..

Parameter	Name	Default	Setting Range	Content
07-00 P.33	COM1 Communication protocol selection	1	0	Modbus protocol
			1	Shihlin protocol
			2	PLC protocol ( Effective when using Shilin built-in PLC )
07-01 P.36	COM1 inverter communication station number	0	0 ~ 254	Maximum inverter connect number is determined by wiring method and impedance matching. Please set its value to a non-zero value when using Modbus protocol.
07-02 P.32	COM1 Serial communication baud rate	1	0	Baud rate:4800bps
			1	Baud rate:9600bps
			2	Baud rate:19200bps
			3	Baud rate:38400bps
			4	Baud rate:57600bps
			5	Baud rate:115200bps
07-03 P.48	COM1 data length	0	0	8bit
			1	7bit
07-04 P.49	COM1 stop bit length	0	0	1bit
			1	2bit
07-05 P.50	COM1 parity check selection	0	0	No parity check
			1	Odd
			2	Even
07-06 P.51	COM1 CR/LF selection	1	1	CR only
			2	Both CR and LF
07-07 P.154	COM1 Modbus communication format	4	0	1, 7, N, 2 (Modbus, ASCII)
			1	1, 7, E, 1 (Modbus, ASCII)
			2	1, 7, O, 1 (Modbus, ASCII)
			3	1, 8, N, 2 (Modbus, RTU)
			4	1, 8, E, 1 (Modbus, RTU)
			5	1, 8, O, 1 (Modbus, RTU)
07-08 P.52	COM1 Number of communication retries	1	0 ~ 10	If communication error times exceed set value of 07-08 (P.52) and 07-10 (P.153) is set to 0, alarm OPT will be reported.
07-09 P.53	COM1 communication interval allowed time	99999	0 ~ 999.8s	Checking communication timeout with the set value
			99999	No timeout check
07-10 P.153	COM1 communication alarm action	0	0	Alarm and stop freely
			1	No alarm and continuing to operation
07-25 P.810	PU communication protocol selection	1	0	Modbus protocol
			1	Shilin protocol
			2	PLC protocol ( Effective when using Shihlin built-in PLC )
07-26 P.811	PU inverter communication station number	0	0 ~ 254	Maximum inverter connect number is determined by wiring method and impedance matching. Please set its value to a non-zero value when using Modbus protocol.

Communication parameter group 07

Parameter	Name	Default	Setting Range	Content
07-27 P.812	PU Serial communication baud rate	1	0	Baud rate 4800bps
			1	Baud rate 9600bps
			2	Baud rate 19200bps
			3	Baud rate 38400bps
			4	Baud rate 57600bps
			5	Baud rate 115200bps
07-28 P.813	PU data length	0	0	8bit
			1	7bit
07-29 P.814	PU stop bit	0	0	1bit
			1	2bit
07-30 P.815	PU Parity check option	0	0	no parity check
			1	odd check
			2	even check
07-31 P.816	PU CR/LF selection	1	1	CR only
			2	Both CR and LF
07-32 P.817	PU Modbus communication format	4	0	1, 7, N, 2 (Modbus, ASCII)
			1	1, 7, E, 1 (Modbus, ASCII)
			2	1, 7, O, 1 (Modbus, ASCII)
			3	1, 8, N, 2 (Modbus, RTU)
			4	1, 8, E, 1 (Modbus, RTU)
			5	1, 8, O, 1 (Modbus, RTU)
07-33 P.818	PU Number of communication retries	1	0 ~ 10	If communication error times exceed 07-33 (P.818) and 07-35 (P.820) is set to 0, PUE alarm will trigger.
07-34 P.819	PU communication interval allowed time	99999	0 ~ 999.8s	Check communication timeout with the set value
			99999	Off
07-35 P.820	PU communication error handling	1	0	Alarm and stop freely.
			1	No alarm and continue running
07-41 P.826	Expansion communication card number of communication retries	1	0 ~ 10	If communication error times exceed 07-41 (P.826) value and 07-42 (P.827) is set to 0, CbE alarm will trigger.
07-42 P.827	Expansion communication card communication error handling	1	0	Alarm and idling and stopping
			1	No alarm and continue running
07-43 P.828	Expansion communication card communication interval allowed time	99999	0 ~ 999.8s	Check communication timeout with the set value
			99999	Off

Setting Shihlin protocol and Modbus protocol

- ◆ If any communication parameter is changed, please power off and restart inverter.
- ◆ SE3 series inverters offer two protocols to choose from: Shihlin protocol and Modbus protocol. Parameters 07-02(P.32), 07-01(P.36), 07-08(P.52), 07-09(P.53) and 07-10(P.153) are for both protocols. Parameter 07-03(P.48)~07-06(P.51) only applies to Shihlin protocol and parameter 07-07(P.154) applies only to Modbus protocol. Please refer to communication protocol for details.

Note: 1. Maximum inverter connect number is determined by wiring method and impedance matching. Please set station number value to non-zero when using Modbus protocol.  
 2. If communication error times exceed set value of 07-08(P.52), and 07-10(P.153) is set to 0, OPT alarm will trigger.  
 3. Modbus protocol is expressed according to start bit, data bit, parity check bit and stop bit. In addition, N means no parity check, E means 1-bit even check, and O means 1-bit odd check

✓ Composition and wiring of SE3 RS485 communication interface

1. Terminal configuration of SE3 RS485 communication interface (COM1)

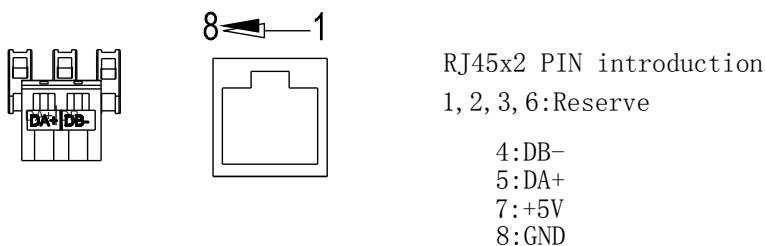

2. Communication between upper controller and a single inverter (take PLC as an example).

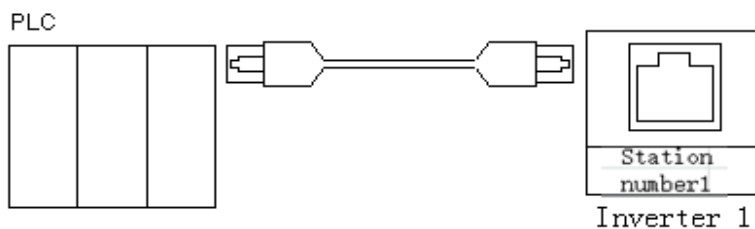

3. Communication between upper controller and multiple inverters (take PLC as an example).

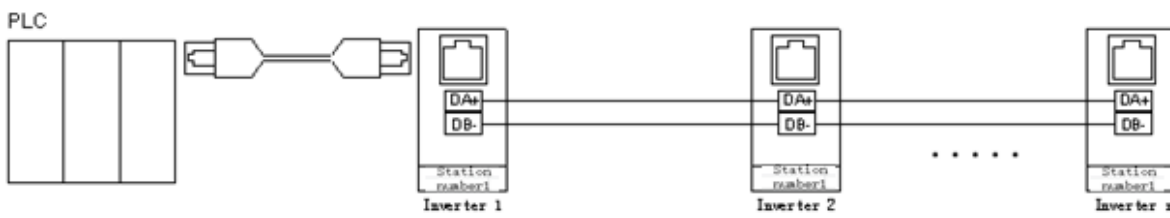

4. SE3 series inverter support Shihlin communication protocol and MODBUS communication protocol.

✓ Shihlin communication protocol

1. Upper controller and inverter automatically converted into ASCII code (hexadecimal) for communication
2. Please follow the steps to perform data communication between upper controller and inverter.

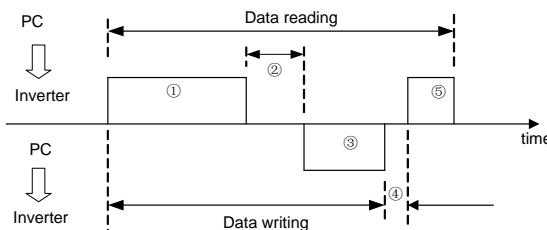

Please refer to the following table for descriptions of communication actions and communication data format type in the above steps:

Communication parameter group 07

No.	Action content	Run command	Frequency write	Parameter write	Inverter reset	Monitoring	Parameter readout	
①	Upper controller user program sends a communication request to inverter	A	A	A	A	B	B	
②	Inverter data processing time	Yes	Yes	Yes	No	Yes	Yes	
③	Inverter return information (check data ① for error)	No error (accept request)	C	C	C	No	E	③
		Error (request denied)	D	D	D	No	D	
④	Upper controller processing delay time	No	No	No	No	No	No	
⑤	Response transferred by upper controller to returned information ③ (check data ③ for error)	No error (not processed)	No	No	No	No	C	⑤
		Error (output ③)	No	No	No	No	F	

①Data of communication request sent by upper controller to inverter.

Format	Data number													
	1	2	3	4	5	6	7	8	9	10	11	12	13	14
A (Data write-in)	ENQ *1)	Inverter station number		Command code	Waiting time *2)		Data				Check code Sum check*7)		End symbol*3)	
B (Data read-out)	ENQ *1)	Inverter station number		Command code	Waiting time *2)		Check code Sum check*7)		End symbol*3)					

③Inverter return information

Data write-in

Format	Data number						
	1	2	3	4	5	6	
C(data is correct)	ACK*1)		Inverter station number		End symbol*3)		
D(data error)	NAK*1)		Inverter station number		Error code*5)		End symbol*3)

Data read-out

Format	Data number												
	1	2	3	4	5	6	7	8	9	10	11	12	13
E(data is correct)	STX*1)	Inverter station number		Data read-out				Unit *4)	ETX	Check code Sum check*7)		End symbol *3)	
D(data error)	NAK*1)	Inverter station number		Error code *5)	End symbol *3)								

⑥Reply data from upper controller to inverter during data read-out.

Format	Data number				
	1	2	3	4	5
C(data is correct)	ACK*1)		Inverter station number		End symbol *3)
F(data error)	NAK*1)		Inverter station number		End symbol *3)

\*1) Control code

Signal	ASCII Code	Content	Signal	ASCII Code	Content
NUL	H00	NULL	ACK	H06	Acknowledge
STX	H02	Start of Text	LF	H0A	Line Feed
ETX	H03	End of Text	CR	H0D	Carriage Return
ENQ	H05	Enquiry	NAK	H15	Negative Acknowledge



\*2) Waiting time set from 0 to 15 with 10ms unit. Example: set value 5 --->50ms.

\*3) End symbol (CR, LF codes)

When performing data communication from upper controller to inverter, CR and LF codes at the end of message will be automatically set according to upper controller mode. At this time, inverter must also make necessary settings to cooperate with upper controller. If only CR is selected, only one register is occupied; If both CR and LF are selected, two registers will be occupied.

\*4) Unit: 0---> Unit 1, 1---> Unit 0.1, 2---> Unit 0.01, 3---> Unit 0.001

\*5) Error code:

Error code	Error item	Communication error content
H01	Parity Check Error	Parity check of data received by inverter is different from parity check initially set
H02	Sum Check Error	Sum Check value calculated by inverter according to received data is different from received Sum Check value
H03	Communication protocol error	Structure of the data received by inverter is incorrect; or data has not been received within specified time; or CR and LF codes are different from those initially set
H04	Frame error	Stop bit of data received by inverter is inconsistent with stop bit initially set
H05	Overflow error	When inverter is receiving data (not all data have been received yet), upper controller transmits next data to it.
H0A	Wrong mode	Write when inverter is running or mode setting requirements are not met
H0B	Command code error	A command code that cannot be processed by inverter is specified
H0C	Data range error	When setting parameters and frequencies, data outside the set range are specified

\*6) When the parameter has the characteristics of 99999, the write-in or read-out of 99999 will be replaced by HFFFF.

\*7) Request sum check code

ASCII-converted code of the data is added in binary code, and the lower bit (lower 8 bits) of the result (summation) is converted to ASCII 2 bits (hexadecimal), which is called SumCheck Code.

✓ Communication example:

Example 1. Upper controller sends a forward rotation command to inverter:

Step 1: Use the upper controller to send a FA command in Format A:

ENQ	Inverter station number	Command code	Waiting time	Data	Check code Sum Check	CR
H05	H30 H30	H46 H41	H30	H30 H30 H30 H32	H44 H39	H0D

Sum Check calculation is:  $H30 + H30 + H46 + H41 + H30 + H30 + H30 + H30 + H32 = H1D9$ , take the lower eight bits D9 to convert to ASCII code H44 and H39.

Step 2: After receive and processing the data without error, inverter will send reply to upper controller in Format C:

ACK	Inverter station number	CR
H06	H30 H30	H0D

Example 2. Upper controller sends a stop rotation command to inverter:

Step 1: Use upper controller to send FA command in Format A:

ENQ	Inverter station number	Command code	Waiting time	Data	Check code Sum Check	CR
H05	H30 H30	H46 H41	H30	H30 H30 H30 H30	H44 H37	H0D

Step 2: After receive and processing the data without error, inverter will send reply to upper controller in Format C:

ACK	Inverter station number	CR
H06	H30 H30	H0D

Communication parameter group 07

Example 3. Upper controller reads the value of 02-15(P.195):

Step1: Upper controller sends write and page change command, using Format A:

ENQ	Inverter station number 0	Command code HFF	Waiting time	Data H0001	Check code Sum Check	CR
H05	H30 H30	H46 H46	H30	H30 H30 H30 H31	H44 H44	H0D

02-15(P.195)is on page 1

Step 2: After receive and processing the data without error, inverter will send reply to upper controller in Format C:

ACK	Inverter station number 0	CR
H06	H30 H30	H0D

Step 3: Upper controller requests inverter for reading 02-15(P.195) value using Format B:

ENQ	Inverter station number 0	Reference code H5F	Waiting time	Check code Sum Check	CR
H05	H30 H30	H35 H46	H30	H30 H42	H0D

195 minus 100 equals 95, convert 95 to H5F in hex. Next convert 5 and F to H35 and H46, in ASCII.

Step 4: Once inverter receives and processes the data without error, 02-15(P.195) value will be sent to upper controller in Format E:

STX	Inverter station number 0	Read-out data H1770 (60Hz)	Unit	ETX	Check code Sum Check	CR
H02	H30 H30	H31 H37 H37 H30	H32	H03	H36 H31	H0D

Example 4. Change the content of 02-15(P.195) to 50 (Default setting is 60).

Step 1~2 are the same as Step 1~2 of Example 3;

Step 3: Upper controller requests inverter to write 50 in 02-15(P.195) in Format A:

ENQ	Inverter station number 0	Reference code HDF	Waiting time	Data H1388	Check code Sum Check	CR
H05	H30 H30	H44 H46	H30	H31 H33 H38 H38	H45 H45	H0D

195 minus 100 equals 95;  
Convert 95 to H5F in hex,  
H5F+H80=HDF

02-15(P.195) smallest unit is 0.01,  
50 x 100 = 5000; convert 5000 to H1388 in hex  
Then covert 1, 3, 8, 8 to ASCII codes for transmission.

Step 4: After receive and processing the data without error, inverter will send reply to upper controller in Format C:

ACK	Inverter station number 0	CR
H06	H30 H30	H0D

Example 5. Write 500 into 02-15(P.195) (this parameter range is set from 0 to 400)

Step 1~2 are the same as Step 1~2 of Example 3;

Step 3: Upper controller requests inverter to write 500 in 02-15(P.195) in Format A:

ENQ	Inverter station number 0	Reference code HDF	Waiting time	Data HC350	SUM CHECK	CR
H05	H30 H30	H44 H46	H30	H43 H33 H35 H30	H46 H35	H0D

Step 4: After receive and processing the data, the data exceed the range of 02-15(P.195), so data range is incorrect. Inverter will reply error to upper controller in Format D:

NAK	Inverter station number 0	Error code H0C	CR
H15	H30 H30	H43	H0D

Note: In above examples, parameters 02-15 (P.195) reading and writing are all using P parameter mode. To use parameter group mode, please note the difference between page number and parameter number. Please refer to the communication command list for relevant contents.

- ✓ MODBUS communication protocol
- ✓ Message format

MODBUS serial transmission can be divided into two types: ASCII (American Standard Code for Information Interchange) and RTU(Remote Terminal Unit).

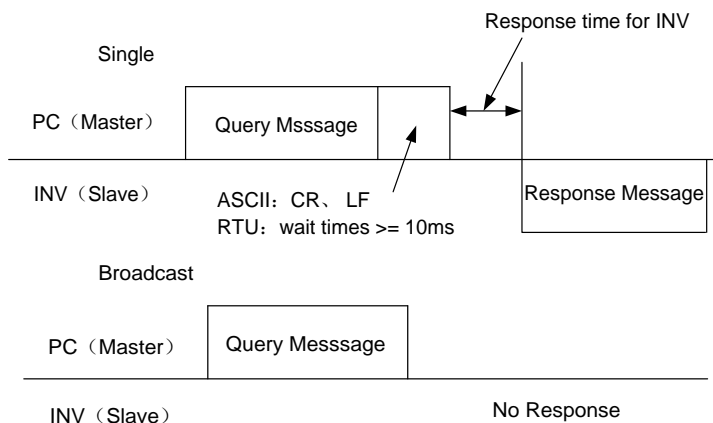

(1) Query

Upper controller (master address) sends data to Slave (slave address) with specified address.

(2) Normal Response

After receiving the query from Master, Slave will execute requested function and ask Master to send normal response.

(3) Error Response

When receiving wrong function codes, address or data, inverter will send this response to Master.

(4) Broadcast

After Master specifies address 0, it can send data to all Slave. All Slave that received Master data will perform the requested function but will not return a respond to Master.

- ✓ Communication format:

In general, Master sends Query Message to Slave, which returns Response Message to Master. During normal communication, address codes and function codes are copied. During abnormal communication, function code bit7 is set to "1" (=H80), and Data Byte is set to error code.

- ✓ Message composition:

Format	Start	①Address	②Function	③Data	④Error check	Stop
ASCII	H3A	8bits	8bits	n×8bits	2×8bits	0D 0A
RTU	>=10ms					>=10ms

## Communication parameter group 07

Message	Content															
① Address information group	Setting range: 0~254. 0 is for broadcast address, 1~254 for slave device (inverter) address. 07-01(P.36) is used to set the Slave device address when Master device sends information to the Slave device and the Slave device replies information to Master device..															
② Function information group	<p>At present, there are four functions. Slave device acts according to the request of Master device. If Master device sets a function code other than the table below, Slave device will return an error response. Normal function code will be returned when response is normal, and H80+ function code will be returned when response is wrong.</p> <table border="1"> <thead> <tr> <th>Function name</th> <th>Function code</th> <th>Function description</th> </tr> </thead> <tbody> <tr> <td>Read multiple registers</td> <td>H03</td> <td>Read Slave's continuous register content.</td> </tr> <tr> <td>Write single register</td> <td>H06</td> <td>Write data into Slave's single register.</td> </tr> <tr> <td>Function diagnosis</td> <td>H08</td> <td>Function diagnosis(only for communication check)</td> </tr> <tr> <td>Write multiple registers</td> <td>H10</td> <td>Data can be written to Slave's multiple registers.</td> </tr> </tbody> </table>	Function name	Function code	Function description	Read multiple registers	H03	Read Slave's continuous register content.	Write single register	H06	Write data into Slave's single register.	Function diagnosis	H08	Function diagnosis(only for communication check)	Write multiple registers	H10	Data can be written to Slave's multiple registers.
Function name	Function code	Function description														
Read multiple registers	H03	Read Slave's continuous register content.														
Write single register	H06	Write data into Slave's single register.														
Function diagnosis	H08	Function diagnosis(only for communication check)														
Write multiple registers	H10	Data can be written to Slave's multiple registers.														
③ Data information group	Change according to function code, including initial address, number of registers written and read, data written, etc.															
④ Error checking information group	ASCII is the check method for LRC, while RTU is the check method for CRC.															

### Calculation of LRC check value in ASCII mode:

LRC check is relatively simple, which is used in ASCII mode and can detect all contents in the information domain except the starting colon and the ending carriage return character, it superimpose each data to be transmitted according to bytes (not ASCII code). If the obtained result is greater than hexadecimal H100, remove the excess part (for example, if hexadecimal H136 is obtained, only retain H36), obtain the inverse code of the remaining part and add 1 to it..

### Calculation of CRC check value in RTU mode:

1. Add a 16-bit register with every bit set to 1.
2. Perform an xor operation between the upper byte of the 16-bit register and the initial 8-bit byte, the result of which is put into this 16-bit register.
3. Move this 16-bit register one bit to the right.
4. If the bit moved to the right (marked bit) is 1, perform an xor operation between the generated polynomial 1010000000000001 with this register. If the bit moved to the right is 0, 3 will be returned.
5. Repeat steps 3 and 4 until 8 bits are removed.
6. Perform an xor operation between another 8 bits with this 16-bit register.
7. Repeat steps 3 to 6 until all bytes of the message are performed xor operation with the 16-bit register and bit has been moved for 8 times.
8. The content of this 16-bit register is the 2-byte CRC error check code, which will be added to the highest significant bit of the message.

When adding CRC to the message, the low byte is added first, then the high byte.

✓ Communication format:

### 1. Data readout (H03)

Mode	Start	Address*1)	Function*2)	Start Address*3)	Number of register*4)	Check	Stop
ASCII	H3A	2char	2char	4char	4char	2char	0D 0A
RTU	>=10ms	8bit	8bit	2byte	2byte	2byte	>=10ms

#### Normal response

Mode	Start	Address*1)	Function*2)	Readout data number *5)	Readout data*6)	Check	Stop
ASCII	H3A	2char	2char	2char	4char    ...2N×8bit	2char	0D 0A
RTU	>=10ms	8bit	8bit	1byte	2byte    ...N×8bit	2byte	>=10ms

Message	Content
*1)Address	Set the address for sending information, 0 is invalid
*2)Function code	H03
*3)Start address	Set the address of the register to be read
*4)Number of registers	Set the number of registers to be read. The maximum number is 20.
*5)Read data number	Twice as much as *4)
*6)Read data	Set the data specified in *4)and read the data from high byte to low byte.

### 2. Data write in (H06)

Mode	Start	Address*1)	Function*2)	Start Address*3)	Write-in data*4)	Check	Stop
ASCII	H3A	2char	2char	4char	4char	2char	0D 0A
RTU	>=10ms	8bit	8bit	2byte	2byte	2byte	>=10ms

#### Normal response

Mode	Start	Address*1)	Function*2)	Start Address*3)	Write-in data*4)	Check	Stop
ASCII	H3A	2char	2char	4char	4char	2char	0D 0A
RTU	>=10ms	8bit	8bit	2byte	2byte	2byte	>=10ms

Message	Content
*1)Address	Set the address for sending information
*2)Function code	H06
*3)Start address	Set as the start address of the register that needs to be written
*4)Write data	Write data to the specified register, fixed at 16bit.

Note: The content of normal response is the same as query information.

### 3. Write multiple registers (H10)

Mode	Start	Address *1)	Function *2)	Start Address *3)	Number of register *4)	Data*5)	Write-in data *6)	Check	Stop
ASCII	H3A	2char	2char	4char	4char	2char	4char    ...2N×8bit	2char	0D 0A
RTU	>=10ms	8bit	8bit	2byte	2byte	1byte	2byte    ...N×16bit	2byte	>=10ms

Normal response

Mode	Start	Address*1)	Function*2)	Start Address*3)	Number of register *4)	Check	Stop
ASCII	H3A	2char	2char	4char	4char	2char	0D 0A
RTU	>=10ms	8bit	8bit	2byte	2byte	2byte	>=10ms

Message	Content
*1)Address	Set the address for sending information
*2)Function code	H10
*3)Start address	Set as the <b>starting</b> address for the register that needs to be written
*4) Number of registers	Sets the number of registers written. The maximum number is 20.
*5) Number of data	Setting range is 2~24. Set 2 times the value specified in *4).
*6) Write data	Set data division specified in *4). Write data is set in the order of <b>high byte to low byte</b> . Setting is performed in the order of <b>starting</b> address data, <b>starting address +1</b> data, <b>starting address +2</b> data ...

4. Function Diagnosis (H08)

In order to send the query information, the query information (function of subfunction code H00) is returned as it is, and communication check can be performed.

Sub-function code H00 (return of query data)

The query information

Mode	Start	Address*1)	Function*2)	Subroutine *3)	Data *4)	Check	End
ASCII	H3A	2char	2char	4char	4char	2char	0D 0A
RTU	>=10ms	1byte	1byte	2byte	2byte	2byte	>=10ms

Normal response

Mode	Start	Address*1)	Function*2)	Sub-function *3)	Data *4)	Check	End
ASCII	H3A	2char	2char	4char	4char	2char	0D 0A
RTU	>=10ms	1byte	1byte	2byte	2byte	2byte	>=10ms

Query information setting

Message	Content
*1)Address	Set the address for sending information, but be unable to broadcast communication (0 is invalid)
*2)Function code	H08
*3)Sub-function code	H0000
*4)Data	The data can be set arbitrarily if the length is 2 byte. Set range is H0000~HFFFF.

5. Error response

If error is contained in the function/address/data received from the device, do function diagnosis;

However, when using function code H03 or H10 to access more than one address, if one or more data can still operated, it will not be seen as an error.

Mode	Start	Address*1)	Function*2) H80+function	Error code * 3)	Check	End
ASCII	H3A	2char	2char	2char	2char	0D 0A
RTU	>=10ms	8bit	8bit	8bit	2byte	>=10ms

Message	Content
*1) Address	Set the address for sending information
*2) Function code	Function code set by Master + H80
*3)Error code	Set code in the following table

Error code list:

Source	Code	Meaning	Remarks
Slave reply	H01	illegal function code	In query information sent by Master, the function code cannot be processed by slave device. Function codes are not H03, H06, H08, H10 (Suppose).

Source	Code	Meaning	Remarks
Slave reply	H02	illegal data address	In query information sent by Master, the address cannot be processed by Slave (outside the addresses listed in the table, the reserved parameters, the parameters not allowed to be read, the parameters not allowed to be written).
	H03	illegal data value	In query information sent by Master, the data cannot be processed by the Slave (outside parameter writing range, required specified mode, other error, etc.).

Note: When reading multiple parameters, **it is not an error even if there are one or more reserved parameters available to read.**

In data sent by Master, Slave (inverter) will detect the following errors, but will not respond when it detects the error.

Error detection item table:

Error item	Error content
Parity error	The parity test for data received by the inverter is different from the parity test set at the initial stage.
Frame error	The stop byte of the data received by the inverter mismatches the stop byte set at the initial stage.
Overflow error	When the inverter is receiving data, the host computer sends the next set of data before the inverter finishes receiving the current one.
Error test	The LRC/CRC calculated by the inverter according to the received data is different from the received LRC/CRC.

✓ Communication example:

Example 1. CU operation mode written by communication.

Step 1: Upper controller modifies operation mode of inverter.

Mode	Start	Address	Function	Start address		Write data		Check	Stop
ASCII	H3A	H30 H31	H30 H36	H31H30	H30 H30	H30 H30	H30 H30	H45 H39	0D 0A
RTU	>=10ms	01	06	10	00	00	00	8D 0A	>=10ms

Step 2: After receiving and processing the data without error, inverter will send a reply to upper controller:

Mode	Start	Address	Function	Start address		Write data		Check	Stop
ASCII	H3A	H30 H31	H30 H36	H31H30	H30 H30	H30 H30	H30 H30	H45 H39	0D 0A
RTU	>=10ms	01	06	10	00	00	00	8D 0A	>=10ms

Example 2. Read parameter 02-15(P.195) value by upper controller

Step 1: Upper controller sends message to inverter to read 02-15(P.195) value. 02-15(P.195) address is H00C3.

Mode	Start	Address	Function	Start address		Number of registers		Check	Stop
ASCII	H3A	H30 H31	H30 H33	H30H30	H43 H33	H30 H30	H30 H31	H33 H38	0D 0A
RTU	>=10ms	01	03	00	C3	00	01	74 36	>=10ms

Communication parameter group 07

Step 2: After receive and processing the data without error, inverter will send 02-15(P.195) to upper controller.

Mode	Start	Address	Function	Number of data read	Read data		Check	Stop
ASCII	H3A	H30 H31	H30 H33	H30 H32	H31 H37	H37 H30	H37 H33	0D 0A
RTU	>=10ms	01	03	02	17	70	B6 50	>=10ms

Decimal form of H1770 is 6000 and the unit of 02-15(P.195) is 0.01, 02-15(P.195) is 60 (6000 x 0.01 = 60).

Example 3. Upper controller change inverter 02-15(P.195) value to 50.

Step 1: Upper controller sends message to inverter to write 50 into 02-15(P.195).

Mode	Start	Address	Function	Start address		Write data		Check	Stop
ASCII	H3A	H30 H31	H30 H36	H30H30	H43 H33	H31 H33	H38 H38	H39 H42	0D 0A
RTU	>=10ms	01	06	00	C3	13	88	74 A0	>=10ms

Step 2: After receive and processing the data without error, inverter will send a reply to upper controller:

Mode	Start	Address	Function	Start address		Write data		Check	Stop
ASCII	H3A	H30 H31	H30 H36	H30H30	H43 H33	H31 H33	H38 H38	H39 H42	0D 0A
RTU	>=10ms	01	06	00	C3	13	88	74 A0	>=10ms

Example 4. Upper controller read parameters 01-10(P.0), 01-00(P.1), 01-01(P.2), 01-03(P.3), 04-00~04-02/P.4~P.6, 01-06~01-07/P.7~P.8, 06-00(P.9), 10-00~10-01/P.10~P.11.

Step 1: Upper controller sends message to inverter for reading 01-10(P.0), 01-00(P.1), 01-01(P.2), 01-03(P.3), 04-00~04-02/P.4~P.6, 01-06~01-07/P.7~P.8, 06-00(P.9), 10-00~10-01 /P.10~P.11 value. Start address is H0000.

Mode	Start	Address	Function	Start address		Number of registers		Check	Stop
ASCII	H3A	H30 H31	H30 H33	H30H30	H30 H30	H30 H30	H30 H43	H46 H30	0D 0A
RTU	>=10ms	01	03	00	00	00	0C	45 CF	>=10ms

Step 2: After receive and processing the data without error, inverter will send a reply to upper controller:

Mode	Start	Address	Function	Number of data read	Read out data	Check	Stop
ASCII	H3A	H30 H31	H30 H33	H31 H38	...12x4 char	2char	0D 0A
RTU	>=10ms	01	03	18	...12x2 byte	2byte	>=10ms

Example 5. Upper controller write parameters 01-10(P.0), 01-00(P.1), 01-01(P.2), 01-03(P.3), 04-00~04-02/P.4~P.6, 01-06~01-07/P.7~P.8, 06-00(P.9), 10-00~10-01/P.10~P.11.

Step 1: Upper controller sends message to inverter for writing 01-10(P.0), 01-00(P.1), 01-01(P.2), 01-03(P.3), 04-00~04-02/P.4~P.6, 01-06~01-07/P.7~P.8, 06-00(P.9), 10-00~10-01/P.10~P.11.

Mode	Starting	Address	Function	Start address		Number of registers		Data volume	Write-in data	Check	Stop
ASCII	H3A	H30 H31	H31 H30	H30 H30	H30 H30	H30 H30	H30 H43	H31 H38	...Nx4 char	2char	0D 0A
RTU	>=10ms	01	10	00	00	00	0C	18	...Nx2byte	2byte	>=10ms

Step 2: After receive and processing the data without error, inverter will send a reply to upper controller:

Mode	Start	Address	Function	Start address		Number of registers		Check	Stop
ASCII	H3A	H30 H31	H31 H30	H30 H30	H30 H30	H30 H30	H30 H43	H45 H33	0D 0A
RTU	>=10ms	01	10	00	00	00	0C	00 18	>=10ms

Note: In above examples, parameters 02-15 (P.195)reading and writing are all using P parameter mode. To use parameter group mode, please note the difference in address. Please refer to the communication command list for relevant contents.



◆ Communication command list

Set the following command codes and data to perform various operation control, monitoring, etc.

Item		Shihlin protocol command code	Modbus command code	Modbus address	Data content and function description										
Operation mode read out		H7B	H03	H1000	H0000: Communication mode; H0001: External mode; H0002: JOG Mode; H0003: Combined mode 1; H0004: Combined mode 2; H0005: Combined mode 3; H0006: Combined mode 4; H0007: Combined mode 5; H0008: PU Mode; b15   b14 ~ b12   b11 ~ b8   b7 ~ b0 <table border="1" style="display: inline-table; vertical-align: middle;"> <tr> <td style="width: 20px; text-align: center;">1</td> <td style="width: 40px; text-align: center;">Setting value of 00-18</td> <td style="width: 40px; text-align: center;">Setting value of 00-17</td> <td style="width: 40px; text-align: center;">00000000</td> </tr> </table> :second operation mode.	1	Setting value of 00-18	Setting value of 00-17	00000000						
1	Setting value of 00-18	Setting value of 00-17	00000000												
Operation mode write in		HFB	H06/H10												
Inverter status monitoring		H7A	H03	H1001	H0000~H00FF b15: during tuning b14: during inverter reset b13, b12: Reserved b11: inverter EO status b10:PLC operating b9: inverter under voltage b8: inverter voltage stall b7: alarm occurred b6: frequency detect b5: parameter restores to default b4: overload b3: frequency arrive b2: during reverse rotation b1: during forward rotation b0: running										
Target frequency write-in	EEPR OM	HEE	H06/H10	H1009	H0000~ HFDE8 : 0~650.00Hz										
	RAM	HED		H1002											
Special monitor codes read out		H7D	H03	H1013	H0000~H0010: monitor selected information. Please refer to special monitoring code table (H0009 reserved)										
Special monitor codes write in		HF3	H06/H10												
Monitor external operation		H7C	H03	H1012	H0000~H000F: <table border="1" style="display: inline-table; vertical-align: middle; margin-left: 10px;"> <tr> <td style="width: 20px; text-align: center;">b15~b4</td> <td style="width: 20px; text-align: center;">b3</td> <td style="width: 20px; text-align: center;">b2</td> <td style="width: 20px; text-align: center;">b1</td> <td style="width: 20px; text-align: center;">b0</td> </tr> <tr> <td style="text-align: center;">0000 0000 0000</td> <td style="text-align: center;">MRS</td> <td style="text-align: center;">STR</td> <td style="text-align: center;">STF</td> <td style="text-align: center;">RES</td> </tr> </table>	b15~b4	b3	b2	b1	b0	0000 0000 0000	MRS	STR	STF	RES
b15~b4	b3	b2	b1	b0											
0000 0000 0000	MRS	STR	STF	RES											
Inverter reset		HFD	H06/H10	H1101	H9696: function of 00-02=2/P.997=1. When communicating with upper controller, inverter cannot return data to upper controller because inverter is reset.										

Communication parameter group 07

Item	Shihlin protocol command code	Modbus command code	Modbus address	Data content and function description	
Parameter clear	HFC	H06/ H10	H1104	H5A5A	Please refer to parameter recovery table for details.
				H5566	
				H5959	
			H1103	H9966	
				H1106	
			H99AA		
			H9A9A		
H1105	H55AA				
H1102	HA5A5				
Parameter read-out	H00~H63	H03	P mode: H0000~H0513  Parameter group mode: H2710~H2D4 F	1.Please refer to the parameter table for data range and decimal point position 2. Modbus address of each parameter in P parameter mode corresponds to hexadecimal value of parameter number. For example, Modbus address of 04-26 (P.138) is H008A. 3.Modbus address of each parameter in parameter group mode corresponds to hexadecimal value of parameter number +10000. For example, Modbus address of 04-26 (P.138) is 0x28BA.	
Parameter write-in	H80~HE3	H06/ H10			
Line speed feedback read-out	---	H03	H100A	H0000~HFDE8	
Line speed feedback write-in		H06/H10			
Line speed target value read-out	---	H03	H100B	H0000~HFDE8	
Line speed target value write-in		H06/H10			
Tension signal read-out	---	H03	H100C	H0000~H7530	
Tension signal write-in		H06/H10			
Torque command read-out	---	H03	H100D	H0000~H0FA0 (0~400.0%) HF060~HFFFF(-400.0%~0)	
Torque command write-in		H06/H10			
Asynchronous serial communication test	---	H08	H0000 (sub function code for loopback test)	This content can be any numerical value (H0000~HFFFF)	
Operation command write-in	HFA	H06/ H10	H1001	H0000~HFFFF b8~b15: reserved b7: inverter emergency stop (MRS) b6: second function (RT) b5: high speed (RH) b4: medium speed (RM) b3: low speed (RL) b2: reverse rotation (STR) b1: forward rotation (STF) b0: reserved	

Item	Shihlin protocol command code	Modbus command code	Modbus address	Data content and function description	
Monitor the INV real-time data	---	H03	H1014~H102F	Modbus address is as follows: H1014: digital input terminal state. H1015: digital output terminal state. H1016: terminal 2-5 analog input voltage H1017: terminal 4-5 analog input current/voltage H1018: AM-5 terminal output voltage/current H1019: DC bus voltage H101A: inverter electronic thermal accumulation rate H101B: inverter output wattage H101C: inverter temperature rising accumulation rate H101D: inverter NTC temperature accumulation rate H101E: motor electronic thermal accumulation rate H101F: PID control target pressure H1020: PID control feedback pressure H1021: Motor speed (Hz) H1022: terminal M2 input frequency H1023: reserved H1024: reserved H1025: inverter output torque H1026: reserved H1027: EP301 expansion card version number H1028: power factor H1029: output power H102A : Synchronous motor rotor pole position H102B : Motor speed (RPM) H102C : PG feedback speed H102D : Motor rotor position (Z phase is 0) H102E : PG card A1B1 feedback pulse number H102F : PG card A2B2 given number of pulses	
Page change for parameter reading and writing	Read	H7F	---	---	P mode: H0000: P.0~P.99; H0001: P.100~P.199; H0002: P.200~P.299; H0003: P.300~P.399; H0004: P.400~P.499; H0005: P.500~P.599; H0006: P.600~P.699; H0007: P.700~P.799; H0008: P.800~P.899; H0009: P.900~P.999; H000A: P.1000~P.1099; H000B: P.1100~P.1199; H000C: P.1200~P.1299 Parameter group mode: H0064: 00-00~00-99; H0065: 01-00~01-99; H0066: 02-00~02-99; H0067: 03-00~03-99; H0068: 04-00~04-99; H0069: 05-00~05-99; H006A: 06-00~06-99; H006B: 07-00~07-99; H006C: 08-00~08-99; H006D: 09-00~09-99; H006E: 10-00~10-99; H006F: 11-00~11-99; H0070: 12-00~12-99; H0071: 13-00~13-99; H0072: 14-00~14-99; H0073: 15-00~15-99
	Write	HFF			

Item		Shihlin protocol command code	Modbus command code	Modbus address	Data content and function description	
Monitor	Frequency setup	EEPROM RAM	H73 H6D	H1009 H1002	H0000~HFDE8(two decimal points when 00-08=0; one decimal point when non-zero)	
	Output frequency		H6F	H1003	H0000~H9C40(same as above)	
	Output current		H70	H1004	H0000~HFFFF(two decimal points)	
	Output voltage		H71	H1005	H0000~HFFFF(two decimal points)	
	Alarm content			H74	H1007	H0000~HFFFF: last two alarm error code H74/H1007: Error code 1 and 2; b15                      b8 b7                      b0
				H75		Error code 2                      Error code 1
						H75/H1008: Error code 3 and 4; b15                      b8 b7                      b0
				Error code 4                      Error code 3		
					H1008	For error codes, please refer to error code list in parameter 06-40~06-43.

◆ Table for parameter recovery

Data content	P parameter operation	Communication p parameter (Note 1)	Table 1 (Note 2)	Table 2 (Note 2)	User registered parameter	Other p parameter	Error code
H5A5A	00-02=4(P.999=1)	o(Notes 3)	X(Notes 4)	x	o	o	x
H5566	00-02=5(P.999=2)	o	x	o	x	o	x
H5959	00-02=6(P.999=3)	o	x	x	x	o	x
H9966	00-02=3(P.998=1)	o	x	o	o	o	x
H9696	Communication 999 1	x	x	x	o	o	x
H99AA	Communication 999 2	x	x	o	x	o	x
H9A9A	Communication 999 3	x	x	x	x	o	x
H55AA	Communication 998	x	x	o	o	o	x
HA5A5	00-02=1(P.996=1)	x	x	x	x	x	o

Note: 1. Communication P parameters includes 07-02(P.32), 07-00(P.33), 07-01(P.36), 07-03(P.48)~ 07-09(P.53), 00-16(P.79), 07-10(P.153) and 07-07(P.154).

2. Table 1 and table 2 refer to Section 5.1.2 table1 and table 2.

3. "o" represents that parameters can restore to default or error codes can be cleared.

4. "x" represents that parameters and error codes cannot restore.

◆ Special monitor code table

Information	Content	Unit
H0000	Monitor digital input terminal state.	Note.1
H0001	Monitor digital output terminal state.	Note. 2
H0002	Monitor voltage across terminal 2-5.	0.01V
H0003	Monitor voltage/current across terminal 4-5.	0.01mA/0.01V
H0004	Monitor voltage across terminal AM-5.	0.01V
H0005	Monitor DC bus voltage value.	0.1V
H0006	Monitor electronic thermal accumulation rate	---
H0007	Inverter temperature rising accumulation rate	0.01

Data	Content	Unit
H0008	Inverter output power	0.01kW
H0009	Inverter NTC temperature accumulation	0.01
H000A	Motor electronic thermal accumulation rate	---
H000B	PID control target pressure	0.1%
H000C	PID control feedback pressure	0.1%
H000D	Motor speed (Hz)	0.01Hz
H000E	Terminal HDI input frequency	0.01kHz
H000F	Reserved	---
H0010	Reserved	0.01V
H0011	Inverter output torque	0.1%
H0012	Reserved	0.01V
H1013	Communication expansion card version number	---
H0014	The power factor	0.001
H0015	The output power	0.01kwh/0.1kwh
H0016	Synchronous motor rotor pole position	---
H0017	Motor speed	0.1rpm/1rpm
H0018	PG feedback speed	0.01Hz
H0019	Motor rotor position (Z phase is 0)	---
H001A	PG card A1 B1 feedback pulse number	---
H001B	PG card A2 B2 given number of pulses	---

Note: 1. Digital input terminal state details

b15	b14	b13	b12	b11	b10	b9	b8	b7	b6	b5	b4	b3	b2	b1	b0
0	0	0	0	0	0	0	0	0	0	RES	M2	M1	M0	STR	STF

2. Digital output terminal state details

b15	b14	b13	b12	b11	b10	b9	b8	b7	b6	b5	b4	b3	b2	b1	b0
0	0	0	0	A17	A16	A15	A14	A13	A12	A11	A10	0	0	ABC	SO

expanded digital output

### 5.8.2 Communication EEPROM write selection

➤ Use this function if parameter settings are frequently written by communication.

Parameter	Name	Default	Setting Range	Content
07-11 P.34	Communication EEPROM write-in selection	0	0	When writing parameters in communication mode, write in RAM and EEPROM
			1	When writing parameters through communication, only write into RAM

Setting Communication EEPROM write selection

- ◆ When parameter write in is performed by RS485, parameters can store in EEPROM + RAM or RAM only.
- ◆ If change parameter value frequently, set "1" in 07-11(P.34). When 07-11(P.34) set to "0" EEPROM lifetime will be shorter due to constantly write in.

Note: Set 07-11 (P.34) =1 (RAM only), when the power of inverter is turned off, parameters changed will not be memorized. When power on again, all parameters will still be the setting previously saved in EEPROM.

### 5.8.3 CANopen protocol

➤ Setting for using CANopen communication card (optional)

Parameter	Name	Default	Setting Range	Content
07-15 P.800	CANopen slave address	0	0 ~ 127	---
07-16 P.801	CANopen speed	0	0	1Mbps
			1	500Kbps
			2	250K/280Kbps
			3	125Kbps
			4	100Kbps
			5	50Kbps
07-17 P.802	CANopen communication status	0	0	Node retry status
			1	Communication retry status
			2	Retry completion status
			4	Stop state
			5	Operating state
			127	Preoperational state
07-18 P.803	CANopen control status	0	0	Boot not completed status
			1	Forbidden operation state
			2	Pre-excitation status
			3	Excitation state
			5	Allowed operating status
			7	Quick action stop status
			13	Trigger error action status
			14	Error status

Setting CANopen protocol

◆ Parameters 07-17(P.802) and 07-18(P.803) are Read only parameters, which are used to monitor the status of CANopen communication card (optional) in use.

### 5.8.4 Communication card version

➤ Show expansion card program version.

Parameter	Name	Default	Setting Range	Content
07-44 P.829	Version of EP301 communication card	Read only	Read only	---

## 5.8.5 Ethernet communication

## ➤ Using EP301 communication expansion card related Settings

Parameter	Name	Default	Setting Range	Content
07-45 P.830	IP configuration	0	0	Static IP
			1	Dynamic IP
07-46 P.831	IP address 1	192	0~255	
07-47 P.832	IP address 2	168	0~255	
07-48 P.833	IP address 3	2	0~255	
07-49 P.834	IP address 4	102	0~255	
07-50 P.835	Subnet mask 1	255	0~255	
07-51 P.836	Subnet mask 2	255	0~255	
07-52 P.837	Subnet mask 3	255	0~255	
07-53 P.838	Subnet mask 4	0	0~255	
07-54 P.839	Default gateway 1	192	0~255	
07-55 P.840	Default gateway 2	168	0~255	
07-56 P.841	Default gateway 3	2	0~255	
07-57 P.842	Default gateway 4	100	0~255	

Setting

Ethernet communication Settings

- ◆ For 07-45(P.830)~07-57(P.842) details, please refer to EP301 EtherNet communication card manual.

## 5.9 PID parameter group 08

Group	Parameter Number	Name	Setting Range	Default	Page
08-00	P.170	PID function selection	0: Off	0	<a href="#">192</a>
			0X: Parameter 08-03(P.225) as target value.		
			1X: Terminal 2-5 input as target source		
			2X: Terminal 4-5 input as target source		
			3X: Reserved		
			4X: Terminal M2 input as target source		
			X1: Terminal 2-5 input as feedback source		
			X2: Terminal 4-5 input as feedback source		
		X3:Reserved			
08-01	P.171	PID feedback control method	0: Negative feedback control.	0	<a href="#">192</a>
			1: Positive feedback control.		
08-02	P.241	PID sampling period	0 ~ 60000 ms	20ms	<a href="#">192</a>
08-03	P.225	PID target value	0 ~ 08-43(P.251)	20.0%	<a href="#">192</a>
08-04	P.172	Proportional gain	0.1% ~ 1000.0%	20.0%	<a href="#">192</a>
08-05	P.173	Integral time	0 ~ 60.00s	1.00s	<a href="#">192</a>
08-06	P.174	Differential time	0 ~ 10000ms	0ms	<a href="#">193</a>
08-07	P.175	Abnormal deviation	0 ~ 100.0%	0.0%	<a href="#">193</a>
08-08	P.176	Abnormal duration time	0~600.0s	30.0s	<a href="#">193</a>
08-09	P.177	Abnormal processing mode	0: Stop freely	0	<a href="#">193</a>
			1: Slow down to stop		
			2: Alarm and continue operation		
08-10	P.178	Sleep detection deviation	0 ~ 100.0%	0.0%	<a href="#">193</a>
08-11	P.179	Sleep detection duration time	0 ~ 255.0s	1.0s	<a href="#">193</a>
08-12	P.180	Wake-up level	0 ~ 100.0%	90.0%	<a href="#">193</a>
08-13	P.181	Stop level	0 ~ 120.00Hz	40.00Hz	<a href="#">193</a>
08-14	P.182	Upper integral limit	0 ~ 200.0%	100.0%	<a href="#">193</a>
08-15	P.183	Deceleration step length when stable	0 ~ 10.00Hz	0.50Hz	<a href="#">193</a>
08-20	P.641	Proportional gain P2	0.1% ~ 1000.0%	20.0%	<a href="#">197</a>
08-21	P.642	Integral time I2	0 ~ 60.00s	1.00s	<a href="#">197</a>
08-22	P.643	Differential time D2	0 ~ 10000ms	0ms	<a href="#">197</a>
08-23	P.644	Auto adjustment for PID parameters	0:Adjust according to the feedback deviation value	0	<a href="#">197</a>
			1: Adjust according to the curling radius.		
			2: Adjust according to the operation frequency		
			3: Adjust according to the line speed		
08-24	P.711	PID target signal filter time	0 ~ 650.00s	0.00s	<a href="#">198</a>
08-25	P.712	PID feedback signal filter time	0 ~ 60.00s	0.00s	<a href="#">198</a>



Group	Parameter Number	Name	Setting Range	Default	Page
08-26	P.713	PID output signal filter time	0 ~ 60.00s	0.00s	<u>198</u>
08-27	P.714	PID deviation control limit	0 ~ 100.00%	0.00%	<u>198</u>
08-28	P.715	Integral separated property	0: Off	0	<u>199</u>
			1: Integral separated		
08-29	P.716	Integral separated point	0 ~ 100.00%	50.00%	<u>199</u>
08-30	P.717	PID differential limit	0 ~ 100.00%	0.10%	<u>199</u>
08-31	P.718	PID output positive deviation limit	0 ~ 100.00%	100.0%	<u>199</u>
08-32	P.719	PID output negative deviation limit	0 ~ 100.00%	100.0%	<u>199</u>
08-33	P.720	PID parameter switchover operation selection	0: No PID parameter switchover.	0	<u>200</u>
			1: PID parameter switchover based on deviation.		
08-34	P.721	PID parameter switchover deviation lower limit	0 ~ 100.00%	20.00%	<u>200</u>
08-35	P.722	PID parameter switchover deviation upper limit	0 ~ 100.00%	80.00%	<u>200</u>
08-36	P.723	PID disconnection operation option 1	0: Select no need to run to the upper limit when PID is disconnected	1	<u>200</u>
			1: Select need to run to the upper limit when PID is disconnected		
08-39	P.726	PID counting when inverter stop action selection	0: PID stop counting when inverter stop	0	<u>200</u>
			1: PID keep counting when inverter stop		
08-40	P.727	PID allowed reverse rotation action selection	0: PID does not allow reverse rotation	0	<u>201</u>
			1: PID allows reverse rotation		
08-41	P.728	PID in reverse direction integral limit	0 ~ 100.0%	0.0%	<u>201</u>
08-42	P.729	PID minimum output frequency	0 ~ 10.00Hz	0.00Hz	<u>201</u>
08-43	P.251	PID target feedback range	1.0 ~ 100.0	100.0	<u>201</u>
08-45	P.253	Feedback disconnection detection time	0 ~ 600.0s	0.0s	<u>202</u>
08-46	P.254	Feedback disconnection processing method	0: AEr alarm is reported and the inverter stops freely	0	<u>202</u>
			1: After deceleration to stop, AEr alarm is reported		
			2: Continue to run, output disconnection alarm is reported around multifunction digital output terminal		

### 5.9.1 PID function selection

- Inverter can control flow, volume or pressure by PID control. By using analog signal or parameter setting as target source, and with analog signal as feedback source, it forms a closed loop control system.

Parameter	Name	Default	Setting Range	Content
08-00 P.170	PID function selection	0	0	Off
			0X	Parameter 08-03(P.225) as target value.
			1X	Terminal 2-5 input as target source
			2X	Terminal 4-5 input as target source
			3X	Reserved
			4X	Terminal HDI input as target source
			X1	Terminal 2-5 input as feedback source
			X2	Terminal 4-5 input as feedback source
			X3	Reserved
08-01 P.171	PID feedback control method	0	0	Negative feedback control.
			1	Positive feedback control.

 PID function selection

- ◆ During PID control, frequency displayed on screen is inverter output frequency
- ◆ For terminal 2-5 and terminal 4-5 input signal filtering please refer to parameters 02-10(P.60) 02-22(P.528).

Note: When setting target source and feedback source, please pay attention to 08-00(P.170) and 02-00(P.500)~02-01(P.501) setting, terminal priority : 2-5 > 4-5 .

### 5.9.2 PID parameter group 1

- By setting PID parameters users can realize automatic adjustment of process control.

Parameter	Name	Default	Setting Range	Content
08-02 P.241	PID sampling period	20ms	0~6000ms	Feedback signal sampling period.Adjuster computes once every sampling period. The longer the sampling period, the slower the response.
08-03 P.225	PID target value	20%	0 ~08-43(P.251)	When ten-digit of 08-00 (P.170) is set to 0 and single-digit is not set to 0, the target value is set by 08-03(P.225)
08-04 P.172	Proportional gain	20.0%	0.1% ~ 1000.0%	This gain determines the proportion controller's response on feedback deviation. The greater the gain, the faster the response. Gain set too high will cause vibration.
08-05 P.173	Integral time	1.00s	0 ~ 60.00s	This parameter determines integral controller's integral time. When integral gain is too high, integral effect will be too weak to eliminate steady state deviation. When integral gain is rather small, the system vibration time will increase, and too small integral gain will cause system unstable.

Parameter	Name	Default	Setting Range	Content
08-06 P.174	Differential time	0ms	0 ~ 10000ms	This gain determines deviation controller's response to deviation change rate. Appropriate deviation time can reduce overshooting and vibrating between proportion controller and integral controller. Deviation time set too long will cause system vibration.
08-07 P.175	Abnormal deviation	0.0%	0 ~ 100.0%	---
08-08 P.176	Abnormal duration time	30.0s	0 ~ 600.0s	---
08-09 P.177	Abnormal processing mode	0	0	Stop freely
			1	Slow down to stop
			2	Alarm and continue operation
08-10 P.178	Sleep detection deviation	0.0%	0 ~ 100.0%	---
08-11 P.179	Sleep detection duration time	1.0s	0 ~ 255.0s	---
08-12 P.180	Wake-up level	90.0%	0 ~ 100.0%	---
08-13 P.181	Stop level	40.00Hz	0 ~ 120.00Hz	---
08-14 P.182	Upper integral limit	100.0%	0 ~ 200.0%	When the deviation value accumulated by integral time, need to set an upper limit for deviation accumulation. For example, the upper integral limit of frequency is equal to 01-03 (P.3)* 08-14(P.182).
08-15 P.183	Deceleration step length when stable	0.50Hz	0 ~ 10.00Hz	When feedback pressure reach stopping deviation value and time (in seconds), inverter will decrease frequency by 08-15 (P.183) value per second.

Setting

PID parameter group 1

◆ Calibrating analog feedback signal:

Please refer to 5.3.5~5.3.8 for analog input details.

1. Without feedback signal

Example 1: the user use 0~7V for feedback signal on terminal 2-5

First set proportional parameter 02-14(P.194) =0%, 02-15(P.195) =100%;

Then set voltage parameter 02-12(P.192) =0, 02-13(P.193) =7.

Example 2: the user use 0~20mA for feedback signal on terminal 4-5

First set proportional parameter 02-27(P.196) =0%, 02-28(P.197) =100% ;

Then set current parameter 02-25(P.198) =0, 02-26(P.199) =20.

2. With feedback signal

Example 3: the user use 0~10kg sensor for feedback signal on terminal 2-5

Adjust feedback signal to 0kg, write parameter 02-14 (P.194) = 0%

Adjust feedback signal to 10kg, write parameter 02-15 (P.195) = 100%

PID parameter group 08

Note :1. If need to set analog input in a certain proportional way, adjust analog signal first and then set correspond proportional parameter(like in Example 3). Inverter will automatically calculate related voltage parameter. If skip the analog adjusting part, user must set both proportional parameter and analog parameter (like in Example1.2).

2. If the user wants to calibrate like Example 3, need to connect actual feedback signal.

3. During PID calibration, calibration value must be the upper and lower limits of the selected signal.

4. If use terminal 4-5 as target source or feedback source, please set 02-20(P.17) (with SW2) according to sensor type, and set 02-01(P.501) for terminal 4-5 function, and then perform other operations.

◆ Target pressure given by analog signal:

1. Target given by terminal 2-5(02-00(P.17)=3 and 08-00(P.170)=1X)  
 When 02-08(P.73) = 0, signal range is 0~5V correspond to 0~100%;  
 When 02-08(P.73) = 1, signal range is 0~10V correspond to 0~100%.
2. Target given by terminal 4-5(02-01(P.501)=3 and 08-00(P.170)=2X)  
 Set 02-20(p.17)=0, and the given range is 4-20ma corresponding to 0-100%;  
 Set 02-20(p.17)=1, and the given range is 0~10V corresponding to 0~100%.  
 Set 02-20(p.17)=2, and the given range is 0~5V corresponding to 0~100%.

Example: Set 08-00(P.170) = 2X, 02-01(P.501) = 3 , 02-20(P.17) = 0,02-27(P.196) = 0.0%,02-28(P.197) = 100.0%,02-25(P.198) = 4.00,02-26(P.199)=20.00, It indicates that the PID target value is given by the 4-5 current (4~20mA).If the user is given 8mA, the corresponding proportion is given as  $(8-4) / (20-4) * 100.0 = 25.0$

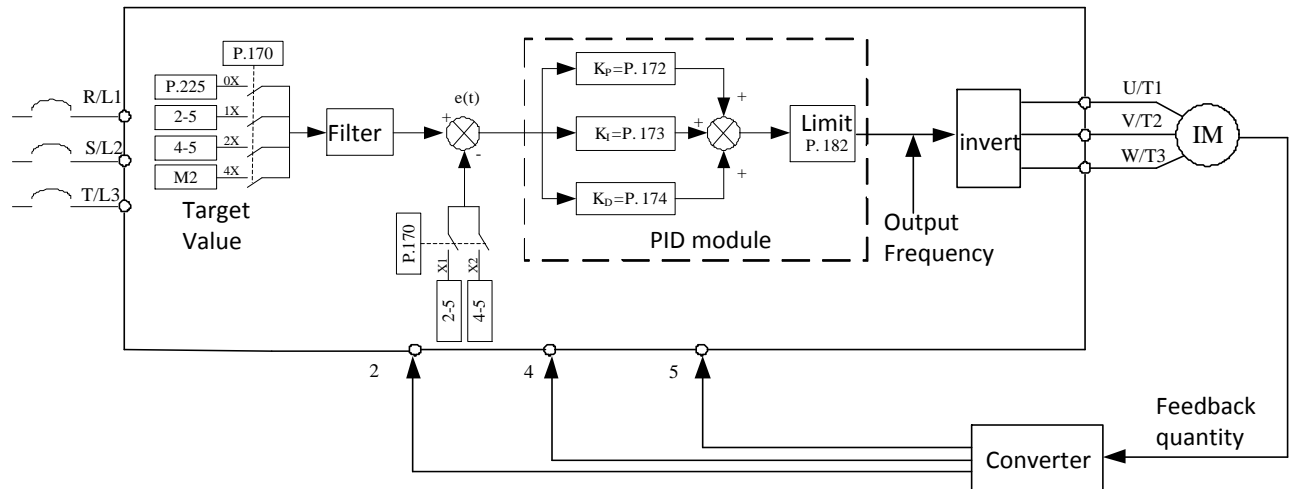

- ◆ If output frequency reaches  $01-03(P.3) * 08-14(P.182)$  and feedback value  $<$  target value  $* 08-07(P.175)$ , and the duration time exceeds 08-08(P.176) value, PID is considered abnormal and inverter will act according to 08-09(P.177) setting.

For example: 08-07(P.175)=60%, 08-08(P.176)=30s, 08-09(P.177)=0,01-03(P.3)=50Hz and 08-14(P.182), output frequency reaches 50Hz, and feedback value is lower than 60% target feedback value for 30 seconds continuously, alarm **PID** will trigger and inverter will stop freely.

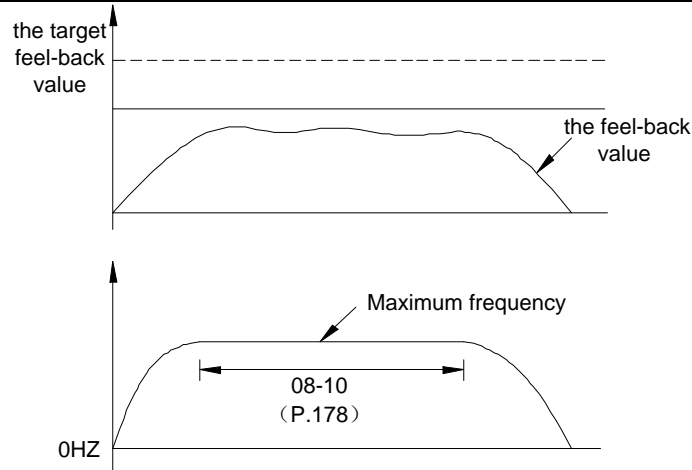

- ◆ If set 08-10(P.178) to 0, all 08-11(P.179), 08-12(P.180), 08-13(P.181), 08-15(P.183) function are off. If 08-10(P.178) is not 0, turn on PID sleep function. If deviation between actual feedback value and target feedback value is less than 08-10(P.178) sleep detection deviation for 08-11(P.179) sleep detection time, inverter will gradually reduce the output frequency. When inverter output frequency is lower than 08-13(P.181) stop level, inverter will decelerate and stop. When feedback value is lower than 08-12(P.180) wake-up level, inverter will start PID again

For example: 08-10(P.178)=5%, 08-11(P.179)=1.0s, 08-12(P.180)=90%, 08-13(P.181)=40Hz, 08-15(P.183)=0.5Hz, If feedback value is greater than 95% and less than 105% of the target, inverter will reduce the output frequency based on 0.5Hz per second. When inverter output frequency is lower than 40Hz, inverter will decelerate and stop. If feedback value is lower than 90% of the target, inverter will wake up and be controlled by PID again.

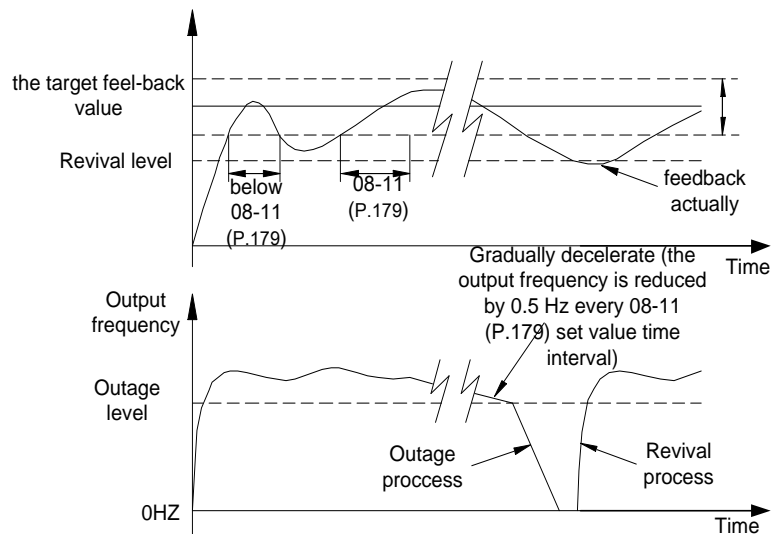

- ◆ PID gain simple setting:

1. After changing target, response is slow  
response is quick but unstable

---Increase P-gain ( $K_P = 08-04(P.172)$ )  
---Decrease P-gain ( $K_P = 08-04(P.172)$ )

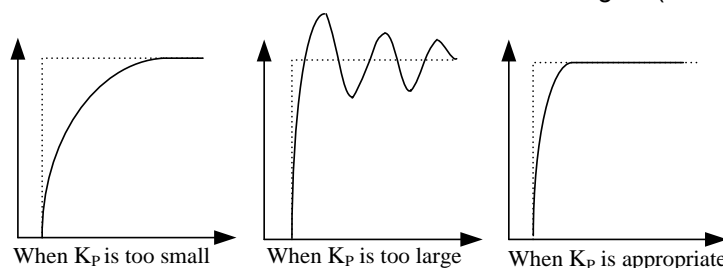

2. Target and feedback have deviation  
become equal after unstable vibration

- Decrease Integration time ( $K_I = 08-05(P.173)$ )  
---Increase Integration time ( $K_I = 08-05(P.173)$ )

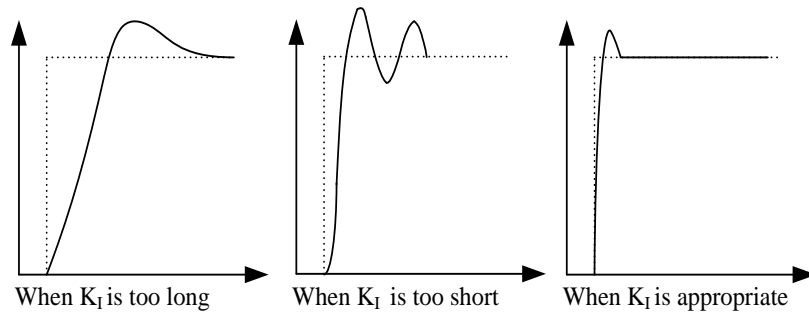

- ◆ Even after increasing  $K_P$ , response is still slow  
It is still unstable

- Increase D-gain ( $K_D = 08-06(P.174)$ )  
---Decrease D-gain ( $K_D = 08-06(P.174)$ )

Note: 1. When 08-09(P.177)=2, keypad will not show alarm but digital output terminal will send signal. This signal can be turned off through 00-02=2(P.997=1) reset or power off.

2. When setting target source and feedback source, please pay attention to 08-00(P.170) and 02-00(P.500) 02-01(P.501) setting

## 5.9.3 PID parameter group 2

➤ This group of parameters is only related to close loop tension mode.

Parameter	Name	Default	Setting Range	Content
08-20 P.641	Proportional gain P2	20.0%	0.1% ~ 1000.0%	This gain determines the proportion controller's response on feedback deviation. The greater the gain, the faster the response. Gain set too high will cause vibration.
08-21 P.642	Integral time I2	1.00s	0 ~ 60.00s	This parameter determines integral controller's integral time. When integral gain is too high, integral effect will be too weak to eliminate steady state deviation. When integral gain is rather small, the system vibration time will increase, and too small integral gain will cause system unstable.
08-22 P.643	Differential time D2	0ms	0 ~ 10000ms	This gain determines deviation controller's response to deviation change rate. Appropriate deviation time can reduce overshooting and vibrating between proportion controller and integral controller. Deviation time set too long will cause system vibration.
08-23 P.644	Auto adjustment for PID parameters	0	0	Adjust according to the feedback deviation value
			1	Adjust according to the curling radius.
			2	Adjust according to the operation frequency.
			3	Adjust according to the line speed.

Setting PID parameter group 2

◆ 08-23(P.644) sets auto adjustment basis for PID parameters.

1. 08-23(P.644)=0, adjust according to feedback deviation value. 08-33 (P.720) = 1, the first group of PID is on when deviation is <08-34 (P.721); the second group of PID functions is on when deviation is > 08-35 (P.722); the deviation is between, PID parameters change linearly between two groups of parameters; when 08-33 (P.720) = 0, only the first group of PID parameters is on.
2. 08-23(P.644)=1, adjust according to curling radius. The first group of PID parameters is used for empty roll, while the second group of PID parameters is used for full roll. The PID parameters change continuously during the process.
3. When 08-23(P.644)=2, adjust according to operation frequency. This first group of PID parameters is used upon zero speed, while the second group of parameters is used upon maximum frequency. The PID parameters change continuously during the process.
4. When 08-23(P.644)=3, adjust according to line speed. This first group of PID parameters is used upon zero speed, while the second group of parameters is used upon maximum line speed. The PID parameters change continuously during the process.

◆ The relationship between PID auto adjustment basis and PID parameters is shown as following diagram:

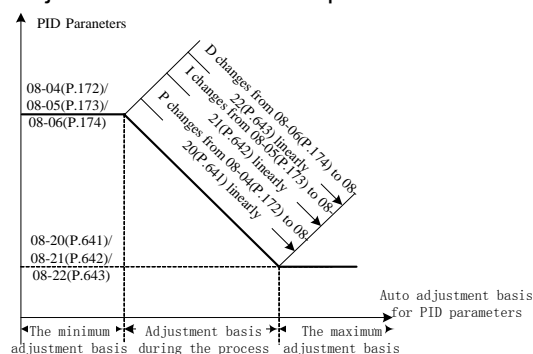

### 5.9.4 PID filter setting

➤ Filter can reduce interference in system, but will reduce response performance.

Parameter	Name	Default	Setting Range	Content
08-24 P.711	PID target signal filter time	0.00s	0 ~ 650.00s	Set PID target signal low-pass filter time constant
08-25 P.712	PID feedback signal filter time	0.00s	0 ~ 60.00s	Set PID feedback signal low-pass filter time constant
08-26 P.713	PIDoutput signal filter time	0.00s	0 ~ 60.00s	Set PID output signal low-pass filter time constant

 Setting PID filter time constant

- ◆ 08-24(P.711) is used to set PID target signal filter time constant, which can reduce the impact caused by PID target signal sudden change in the system.
- ◆ 08-25(P.712) is used to set PID feedback signal filter time constant, which can reduce interference in feedback signal, but will lower system response.
- ◆ 08-26(P.713) is used to set PID output signal filter time constant, which can reduce sudden change of PID output frequency effectively, but will lower system response.

### 5.9.5 PID deviation control limit

➤ If deviation between PID target and PID feedback is smaller than 08-27 value, PID won't change output frequency.

Parameter	Name	Default	Setting Range	Content
08-27 P.714	PID deviation control limit	0.00%	0 ~ 100.00%	If deviation between PID target and PID feedback is smaller than 08-27(P.714) value, PID won't change output frequency.

 Setting PID deviation limit

- ◆ 08-27(P.714) is used to set PID deviation control limit. When deviation between target and feedback is less than 08-27(P.714), PID will stop adjusting output frequency, so when deviation is relatively small, output frequency will remain unchanged, which is very effective for some closed-loop system.



### 5.9.6 PID integral property

- PID integral separation function can effectively reduce overshoot..

Parameter	Name	Default	Setting Range	Content	
08-28 P.715	Integral separated property	0	0	Off	Set whether the integral separation function is valid
			1	Integral separated	
08-29 P.716	Integral separated point	50.00%	0 ~ 100.00%	Set the deviation between target and feedback when integral separate function works.	

 Setting PID integral separated function

- ◆ When set 08-28(P.715) to 1, integral separation is on. If deviation between target and feedback is greater than 08-29(P.716) value, PID will only perform proportional and differential controller, which can reduce the overshoot of PID.

### 5.9.7 PID differential limit

- In PID control, differential controller can cause system to oscillate, so generally differential needs to be limited to a very small range.

Parameter	Name	Default	Setting Range	Content
08-30 P.717	PID differential limit	0.10%	0 ~ 100.00%	Set PID differential limit

 Setting PID differential limit

- ◆ In PID control, differential controller is sensitive and may easily cause system oscillation. Generally differential is set to a small range. 08-30(P.717) is used to set PID differential output range.

### 5.9.8 PID output deviation limit

- PID output deviation limit can control the change of PID output and improve the stability of inverter operation.

Parameter	Name	Default	Setting Range	Content
08-31 P.718	PID output positive deviation limit	100.00%	0 ~ 100.00%	Set the limit for PID two outputs
08-32 P.719	PID output negative deviation limit	100.00%	0 ~ 100.00%	

 Setting PID output deviation limit

- ◆ This function is used to limit the deviation between two PID outputs to suppress the rapid change of PID output and stabilize the running of the inverter.

### 5.9.9 PID parameter switchover

- If one group of PID parameters cannot meet the requirements of the whole process control, two groups of PID can effectively solve the problem.

Parameter	Name	Default	Setting Range	Content
08-33 P.720	PID parameter switchover operation selection	0	0	Off
			1	Switch PID according to deviation
08-34 P.721	PID parameter switchover deviation lower limit	20.00%	0 ~ 100.00%	If deviation is less than 08-34 (P.721), the first group of PID parameters will work. If deviation is greater than 08-35 (P.722), the second group of PID parameters will work. If deviation is between the above two, PID parameters will change linearly.
08-35 P.722	PID parameter switchover deviation upper limit	80.00%	0 ~ 100.00%	

Setting PID parameter switchover

- ◆ In some applications, a group of PID parameters cannot meet the requirements of the whole operation process, so different PID parameters need to be adopted in different situations. Two groups of PID parameters can be automatically switched according to the PID deviation, as shown in the following diagram:

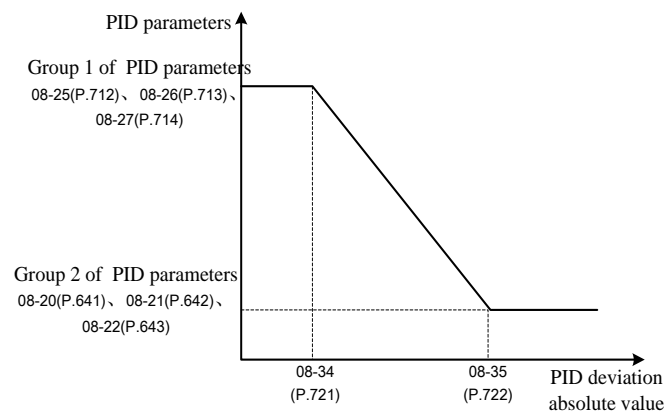

### 5.9.10 PID action when error occurs

- When PID encounter sensor disconnect or inverter stop, 08-39(P.726) and 08-40(P.727) will show different action to apply to different applications.

Parameter	Name	Default	Setting Range	Content
08-36 P.723	PID disconnection operation option	1	0 ~ 1	0: Select no need to run to the upper limit when PID is disconnected 1: Select need to run to the upper limit when PID is disconnected
08-39 P.726	PID counting when inverter stop action selection	0	0	PID stop counting when inverter stop
			1	PID stop counting when inverter stop

Setting PID action when error occurs

- ◆ 08-36(P.723) is used to set PID signal loss action. Once detected PID signal loss, inverter will output alarm.
- ◆ 08-39(P.726) is used to set PID action when inverter stops. Normally PID stops when inverter stops.

### 5.9.11 PID reverse run operation selection

- PID reverse run selections is used to set whether reverse run is allowed when PID calculation result is negative.

Parameter	Name	Default	Setting Range	Content
08-40 P.727	PID allowed reverse rotation action selection	1	0	PID does not allow reverse
			1	PID allow reverse
08-41 P.728	PID in reverse direction integral limit	0.0%	0 ~ 100.0%	It is used to set the upper limit of PID integral when run reverse. Set to 0 when reverse run is not allowed.
08-42 P.729	PID minimum output frequency	0.00Hz	0 ~ 10.00Hz	It is used to set the minimum PID output

 PID reverse run operation selection

- ◆ When PID allows reverse run, 08-41(P.728) should be set greater than 0, generally set to 100.0%. If PID does not allow reverse run, 08-41(P.728) set 0.
- ◆ 08-42(P.729) is used to set the lowest output frequency in PID calculation. If output is less than 08-42(P.729), inverter stops output.

### 5.9.12 Pressure unit (Bar) setting

Used by setting the maximum value of PID target value.

Parameter	Name	Default	Setting range	Content
08-43 P.251	Pressure unit (Bar) setting	100.0	1.0~100.0	Set the maximum value of PID target value.

 Pressure unit (Bar) setting

- ◆ Pressure unit can be set in %, Bar, Kg and so on. If the pressure unit is set to correspond to the dimension of the actual system, please set 08-43(P.251). Generally, it is set to the range of the feedback system sensor.
- ◆ Example: if the pressure sensor feedback range is 0~10V and the corresponding pressure range is 0~16.0 bar, then set 08-43(P.251) to 16.0 and 08-03(P.225) to 8.0. Then 00-07(P.161) = 3 (constant pressure system target pressure) monitoring is 8.0.

5.9.13 PID feedback disconnection detection function

Used to detect PID feedback disconnection.

Parameter	Name	Default	Setting range	Content
08-45 (P.253)	Feedback disconnection detection time	0.0s	0.0 ~ 600.0s	Set the time of feedback disconnection detection. Set to 0 to turn off the function.
08-46 (P.254)	Feedback disconnection processing method	0	0	AEr alarm is reported and the inverter stops freely
			1	After deceleration to stop, AEr alarm is reported
			2	Continue to run, output disconnection alarm is reported around multifunction digital output terminal

Setting PID feedback disconnection detection function

- ◆ Set 08-45(P.253) to a value other than 0. When the PID feedback disconnection timing of the inverter exceeds the time set in 08-45(P.253), the disconnection processing method set in 08-46(P.254) will be performed.
- ◆ Set 08-45(P.253) to 0, then the feedback disconnection detection function will be invalid.

Note: This function is only applicable when the 4-5 analog signal type is 4~20mA.

## 5.10 PG feedback parameter group 09

Group	Parameter Number	Name	Setting Range	Default	Page
09-00	P.349	Encoder type	0 : ABZ	0	<u>204</u>
			1 : ABZ (For synchronous motor)		
			2 : Resolver 1x synchronous motor standard encoder		
			3 : ABZ/UVW synchronous motor standard encoder		
09-01	P.350	Encoder pulse 1	0 ~ 20000	1024	<u>205</u>
09-02	P.351	Encoder input type 1	0 : Off	0	<u>205</u>
			1 : A/Phase B pulse wave , forward spin if Phase A is over Phase B for 90 degrees		
			2 : A/Phase B pulse wave , forward spin if Phase B is over Phase A for 90 degrees.		
			3 : Phase A :pulse wave , Phase B:directional sign , L:reverse spin , H:forward spin		
4 : Phase A :pulse wave , Phase B: directional sign , L:forward spin , H:reverse spin					
09-03	P.352	PG error detection time	0 ~ 100.0s	1.0s	<u>206</u>
09-04	P.353	Overspeed detection frequency	0 ~ 30.00Hz	4.00Hz	<u>206</u>
09-05	P.354	Overspeed detection time	0 ~ 100.0s	1.0s	<u>206</u>
09-06	P.355	Encoder pulse 2	0 ~ 20000	2500	<u>207</u>
09-07	P.356	Encoder input type 2	0 : Off	0	<u>207</u>
			1 : A/Phase B pulse wave, forward spin if Phase A is over Phase B for 90 degrees		
			2 : A/Phase B pulse wave , forward spin if Phase B is over Phase A for 90 degrees		
			3 : Phase A :pulse wave , Phase B:directional sign , L:reverse spin , H:forward spin		
4 : Phase A :pulse wave , Phase B: directional sign , L:forward spin , H:reverse spin					
09-08	P.357	Frequency division output setting	1 ~ 255	1	<u>208</u>
09-09	P.358	Frequency division filter coefficient setting	0 ~ 255	0	<u>208</u>
09-10	P.359	Electronic gear ratio	0 ~ 65.535	1.000	<u>208</u>

## PG feedback parameter group 09

Group	Parameter Number	Name	Setting Range	Default	Page	
09-11	P.360	Anti-reversal detection pulse	0 ~ 65535	0	<a href="#">208</a>	
09-12	P.361	Reversal detection frequency	0 ~ 65535	0	<a href="#">208</a>	
09-13	P.124	Expansion card version	Read only	Read	<a href="#">209</a>	
09-14	P.363	Z phase correction allowance	0.0° : Off	15.0°	<a href="#">209</a>	
			0.1°~360.0° : Z phase pulse correction			
09-15	P.364	Z phase DV1/DV2 alarm enabled	0 : Off	1	<a href="#">209</a>	
			1 : Z phase DV1/DV2 alarm valid			
09-16	P.386	Encoder signal detection setting	1 digit : PG302L hardware disconnection check	0 : Off	1	<a href="#">206</a>
				1 : Valid		
			2 digit : A1/B1 phase sequence check	0 : Off		
				1 : Valid		
<b>09-17</b>	<b>P.416</b>	<b>Encoder installation transmission ratio</b>	<b>0 ~ 65.535</b>	<b>1.000</b>	<a href="#">210</a>	

### 5.10.1 PG type selection

#### ➤ PG ( Pulse Generator )

Parameter	Name	Default	Setting Range	Content
09-00 P.349	PG type setting	0	0	ABZ
			1	ABZ (for synchronous motor)
			2	Resolver 1x synchronized motor standard encoder
			3	ABZ/UVW synchronized motor standard encoder

#### Setting PG type setting

- ◆ Please set the value of parameter 09-00(P.349) according to selected motor and PG card type.
- ◆ Set 09-00(P.349)=0 when pairing PM motor with normal ABZ photoelectric encoder, inverter will set the pull in method or high frequency pulse vibration method to obtain PM motor rotor's initial magnetic pole start position according to 11-08(P.328).
- ◆ PM motor with UVW encoder, set 09-00(P.349)=1. The encoder will send out motor rotor magnetic pole information when sending power for the first time. Inverter activates PM motor according to initial magnetic pole position.If error occurs on inverter, sending power once again will be necessary, or else PM motor error will occur.
- ◆ When PM motor is paired with rotating encoder, 09-00(P.349) should be set to 2. Inverter will read the PM motor rotor magnetic pole position information every time it sends power or returns.Inverter activates the PM motor according to the initial magnetic pole position information.

### 5.10.2 PG1 parameter

➤ For selecting input type of PG1 encoder.

Parameter	Name	Default	Setting Range	Content
09-01 P.350	Encoder pulse 1	1024	0 ~ 20000	---
09-02 P.351	Encoder input type 1	0	0	Off
			1	A/Phase B pulse wave, forward spin if Phase A is over Phase B for 90 degrees
			2	A/Phase B pulse wave, forward spin if Phase B is over Phase A for 90 degrees
			3	Phase A :pulse wave, Phase B:directional sign, L:reverse spin, H:forward spin
			4	Phase A :pulse wave, Phase B: directional sign, L:forward spin, H:reverse spin

#### Setting PG1 parameter

- ◆ 09-01(P.350) and 09-02(P.351) are for the setting of encoder with A1/B1 interface connected to PG card. When controlling in closed loop, the encoder signal for feedback can only be connected to A1/B1 on PG card. 09-01(P.350) is for the setting of the number of pulse generated by the encoder per revolution of the motor, which is the pulse generated by A/Phase B per cycle.
- ◆ Parameter 09-02(P.351) is for setting the input type of encoder , the following is the instructions for each input type of the encoder:

0: Off.

1: A/Phase B pulse wave , forward spin if Phase A is over Phase B for 90 degrees

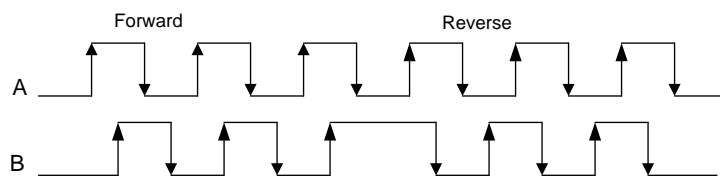

2: A/Phase B pulse wave, forward spin if Phase A is over Phase B for 90 degrees.

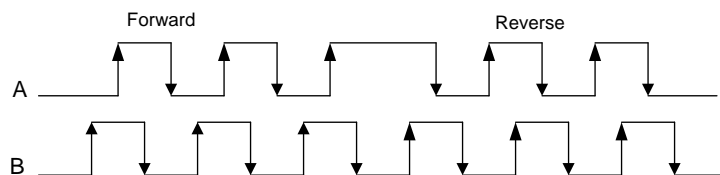

3: Phase A :pulse wave , Phase B:directional sign , L:reverse spin , H:forward spin.

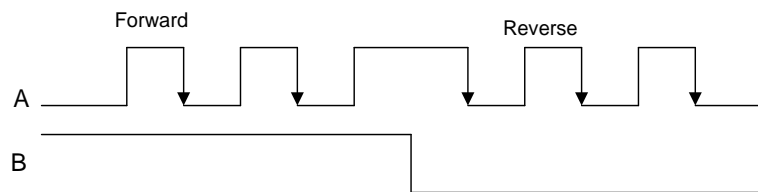

4: Phase A is a pulse train. Phase B is a direction sign. L is forward rotation and H is reverse rotation.

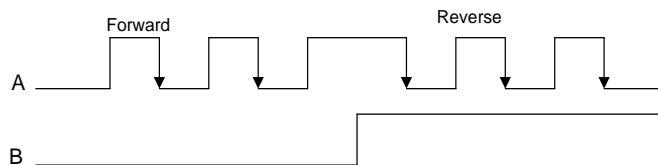

Note : 1. If closed loop control is selected , but 09-02(P.351)=0 , alarm will be displayed and PG1 ends operation。  
 2. PG ends operation if PG card and encoder is wired incorrectly or encoder cannot operate properly.  
 3. When 00-21(P.300)=1 , execute IM motor VF closed loop control. When 00-21(P.300)=4, execute IM motor closed loop vector control ; When 00-21(P.300)=5 , execute PM motor closed loop vector control.  
 4. When 10-03(P.151)=1 , execute zero-speed under closed loop control, execute DC voltage brake under VF closed loop control.

### 5.10.3 PG error detection

➤ The definition of the standard of error detection when PG feedback control.

Parameter	Name	Default	Setting Range	Content
09-03 P.352	PG error detection time	1.0s	0 ~ 100.0s	PG disconnect detection time setting
09-04 P.353	Overspeed detection frequency	4.00Hz	0 ~ 30.00Hz	Motor oversped detection frequency threshold setting
09-05 P.354	Overspeed detection time	1.0s	0 ~ 100.0s	Motor overspeed detection time setting
09-16 P.386	Encoder signal detection setting	1	One digit :	0 : PG302L hardware disconnect detection invalid
				1 : PG302L hardware disconnect detection valid
			Two digit :	0 : A1/B1 phase sequence detection invalid
				1 : A1/B1 phase sequence detection valid

#### Setting PG abnormality detection

- ◆ When executing PG feedback control, if detected frequency is 0, and over the set time of 09-03(P.352), it should be determined as error of PG card's feed back signal. Inverter will display alarm PG2 and end operation. If PG signal error(zero speed)detection time 09-03(P.352) is 0, then no PG card feedback signal error function,i.e.,no alarm PG2.
- ◆ When executing PG feedback control , if different between detected frequency and output frequency is over 09-04(P.353) , and over the time set of 09-05(P.354) , the speed deviation should be determined as too fast. Inverter will display alarm PG3 and end operation. If PG overspeed detection time 09-05(P.354) is set to 0, then no alarm PG3 function.
- ◆ PG302L hardware disconnection detection function ( 09-16(P.386) one-digit ) effective to PM/IM motors , A1/B1 phase sequence detection function ( 09-16(P.386) two digits ) only effective to IM motor



## 5.10.4 PG2 parameter

➤ It is used to select the input mode of PG2 encoder.

Parameter	Name	Default	Setting Range	Content
09-06 P.355	Encoder pulse 2	2500	0 ~ 20000	Setting of A2/B2 encoder information connected to PG03.
09-07 P.356	Encoder input type 2	0	0	Off
			1	A/Phase B pulse wave, forward spin when phase A is over phase B for 90 degrees.
			2	A/Phase B pulse wave, forward spin when phase B is over phase A for 90 degrees.
			3	Phase A :pulse wave, Phase B:directional sign, L:reverse spin, H:forward spin
			4	Phase A :pulse wave, Phase B: directional sign, L:forward spin, H:reverse spin

 PG2 parameter

- ◆ When using PG card, 09-06(P.355) is used for the setting of the number of pulse generated by the encoder per revolution, i.e.,the number of pulse generated by phase A/B per cycle.
- ◆ Parameter 09-07(P.356) is used for the setting of encoder input type. Please refer to parameter 09-02(P.351) for encoder input type.
- ◆ In speed mode, when 09-07(P.356) is not 0, the input pulse of A2/B2 acts as the frequency command (target frequency(0.01Hz)=pulse frequency(Hz) /09-06(P.355)\*09-10(P.359)); After activating inverter, the actual rotate direction of the motor is determined by 09-07(P.356)、 forward/reverse spin command and A2\B2 phase.
- ◆ In position mode, when 09-07(P.356) is not zero, the input pulse of A2/B2 acts as the position command (target position=A2 B2 pulse number\*09-10(P.359)); After activating inverter, the actual spin direction of the motor is determined by 09-07(P.356)、 forward/reverse spin command and A2\B2 phase.

When the frequency command and position command is coming from the input pulse of A2/B2 , the rotate direction is as follow :

Rotation command	09-07(P.356)	A2B2 pulse wave	Actual motor rotation
FWD	1、 3	A2 over B2	forward spin
		B2 over A2	reverse spin
	2、 4	A2 over B2	reverse spin
		B2 over A2	forward spin
REV	1、 3	A2 over B2	reverse spin
		B2 over A2	forward spin
	2、 4	A2 over B2	forward spin
		B2 over A2	reverse spin

## 5.10.5 Dividing frequency output function

➤ Multiplier setting of PG card feedback output.

Parameter	Name	Default	Setting Range	Content
09-08 P.357	Frequency division output setting	1	1 ~ 255	Multiplier setting of PG card foutput and feedback
09-09 P.358	Frequency division filter coefficient setting	0	0 ~ 255	Frequency division filter coefficient setting of PG03 setting

Setting Frequency division output function

- ◆ Parameter 09-08(P.357) is the multiplier setting of the PG card feedback and output. If the feedback is 1024PPR, 09-08(P.357) setting will be 2, and PG card's ( pulse output ) output will be 512PPR.

## 5.10.6 Electronic gear ratio

➤ Electronic gear ratio setting for the pulse input of A2/B2 of PG301 card.

Parameter	Name	Default	Setting Range	Content
09-10 P.359	Electronic gear ratio	1.000	0 ~ 65.535	---

Setting Electronic gear ratio

- ◆ Please refer to parameter 09-07(P.356) for the instructions for 09-10(P.359).

## 5.10.7 Reverse spin detection

➤ The relative settings for PM motor prevent reverse rotation

Parameter	Name	Default	Setting Range	Content
09-11 P.360	Reverse spin prevention detection pulse	0	0 ~ 65535	Setting of the pulse of reverse spin detection of PM motor
09-12 P.361	Reverse spin detection count	0	0 ~ 65535	Setting of the number of reverse spin detection of PM motor

Setting Reverse spin function

- ◆ 09-11(P.360) is for the setting of the number of reverse spin detection pulse. When the motor spins continuously in the opposite direction of the speed command, reverse spin prevention alarm dv4 will be output. Set 09-11(P.360) to 0 when the direction of the load is opposite to the speed command, which cancels the reverse spin prevention alarm. It is only valid in PM motor closed-loop vector control mode.
- ◆ 09-12(P.361) is for the setting of the number of reverse spin detection. When detect acceleration direction is opposite from speed command direction for 09-12(P.361) times, trigger DV3(reverse spin) alarm. When 09-12(P.361)=0, reverse spin prevention alarm will be canceled. It is only valid in Pm motor closed-loop vector control mode.

### 5.10.8 Expansion card version information

- For displaying the current firmware version of the expansion card..

Parameter	Name	Default	Setting Range	Content
09-13 P.124	Expansion card version	Read only	Read only	Used to display the current firmware of the expansion card, read only.

### 5.10.9 PG card Z phase correction margin Z

- Adjust phase Z to clear cumulated error of AB phase.

Parameter	Name	Default	Setting Range	Content
09-14 P.363	Z phase correction margin	15.0°	0.0°	No correction
			0.1°~360.0°	Execute Z phase pulse correction

 Setting Z phase correction margin

- ◆ Judge the pulse deviation value of the AB phase between to neighboring Z phase. Technically, the deviation value=09-01 ( P.350 ) [or 4\*09-01 ( P.350 ) ] , convert into mechanical angle with 360 degrees. When minusing 09-01 ( P.350 ) [or 4\*09-01 ( P.350 ) ] from deviation is lesser than 09-14 ( P.363 ) , and the deviation is greater than 09-04 ( P.363 ) , execute Z phase correction.
- ◆ When Z phase is disturbed by external factors, set 09-14(P.363) to 0..

Note: Only valid when PM motor is in VC mode, IM motor in position mode.

### 5.10.10 DV1/DV2 alarm of PG card Z phase

- For selecting if Z phase DV1/DV2 alarm is enabled

Parameter	Name	Default	Setting Range	Content
09-15 P.364	Z phase DV1/DV2 alarm	1	0	Z phase DV1/DV2 alarm disabled
			1	Z phase DV1/DV2 alarm enabled

 Setting Enable DV1/DV2 alarm of phase Z

- ◆ DV1 is the alarm when Z phase is lost , DV2 is the alarm when noise in Z phase is detected.When 05-15 ( P.364 ) =0 , DV1,DV2 can be canceled.

Note: It is valid only 00-21 ( P.300 ) =5

### 5.10.11 Encoder installation transmission ratio

➤ For selecting the transmission ratio between the encoder shaft and motor shaft

Parameter	Name	Default	Setting Range	Content
09-17 P.416	Encoder installation transmission ratio	1.000	0 ~ 65.535	---

**Setting** Encoder installation transmission ratio

- ◆ It is necessary to set this parameter when the encoder is not installed on the motor shaft and the transmission ratio is not 1:1.
- ◆ The relationship between parameter 09-17(P.416) and mechanical installation is as follow: motor speed / encoder installation shaft speed

## 5.11 Application parameter group 10

Group	Parameter Number	Name	Setting Range	Default	Page
10-00	P.10	DC brake operating frequency	0 ~ 120.00Hz	3.00Hz	<a href="#">215</a>
10-01	P.11	DC brake operating time	0 ~ 60.0s	0.5s	<a href="#">215</a>
10-02	P.12	DC brake operating voltage	0 ~ 30.0%: 7.5K and below	4.0%	<a href="#">215</a>
			0 ~ 30.0%: 11K ~ 22K	2.0%	
10-03	P.151	Zero-speed control function selection	0: Off.	0	<a href="#">216</a>
			1: In close-loop vector control (00-21(P.300) /00-22(P. 370) =4) mode do zero-speed; In V/F close-loop control (00-21(P.300) /00-22(P. 370) =1) mode do DC voltage breaking.		
			2: In close-loop vector mode do zero-servo.		
10-04	P.152	Voltage at zero-speed control	0 ~ 30.0%: 7.5K and below	4.0%	<a href="#">216</a>
			0 ~ 30.0%: from 11K to 22K	2.0%	
10-05	P.242	DC brake before inverter start	0: Off	0	<a href="#">217</a>
			1: Before starting operate DC brake first.		
10-06	P.243	DC brake time before inverter start	0 ~ 60.0s	0.5s	<a href="#">217</a>
10-07	P.244	DC brake voltage before inverter start	0 ~ 30.0%: 7.5K (included) and below	4.0%	<a href="#">217</a>
			0 ~ 30.0%: 11K ~ 22K	2.0%	
10-08	P.150	Restart mode selection	XX0: No frequency search.	0	<a href="#">218</a>
			XX1: Direct frequency search		
			XX2: Decrease voltage mode		
			X0X: Power on once.		
			X1X: Start each time.		
			X2X: Only instantaneous stop and restart		
			0XX: No rotation direction detection.		
			1XX: Rotation direction detection.		
2XX:00-15(P.78)=0, rotation direction detection ; 00-15(P.78)=1/2, no rotation direction detection.					
10-09	P.57	Restart idling time	0 ~ 30.0s	99999	<a href="#">218</a>
			99999: Off.		
10-10	P.58	Restart rising time	0 ~ 60.0s: 7.5K (included)and below.	5.0s	<a href="#">218</a>
			0 ~ 60.0s: 11K ~ 22K	10.0s	
10-11	P.61	Remote control function	0: Off	0	<a href="#">220</a>
			X1: Remote control function, frequency save in memory		
			X2: Remote control function, frequency won't save		
			X3: Remote control function, frequency won't save, clear frequency setting every time STF/STR "turn off".		
			X4: Remote control function, frequency save, the interval between two frequency memory time is not les than 5s		
1X: Target frequency range 01-01(P.2)~01-00(P.1). The target frequency comes from the setting during RH, RM operation.					

Application parameter group 10

Group	Parameter Number	Name	Setting Range	Default	Page
10-12	P.65	Auto reset function	0: Off.	0	<a href="#">222</a>
			1: When over-voltage, inverter will reset.		
			2: When over-current, inverter will reset.		
			3: When either over-voltage or over-current, inverter will reset.		
			4: When any alarm occur, inverter will reset.		
10-13	P.67	Auto reset times	0: Off.	0	<a href="#">222</a>
			1 ~ 10: If the alarm exceeds 10-13(P.67) times, inverter will not reset.		
10-14	P.68	Auto reset waiting time	0 ~ 360.0s	1.0s	<a href="#">222</a>
10-15	P.69	Auto reset times count	Read only	0	<a href="#">222</a>
10-16	P.119	Forward and reverse rotation dead time	0 ~ 3000.0s	0.0s	<a href="#">223</a>
10-17	P.159	Energy-saving control function	0: Off.	0	<a href="#">223</a>
			1: Energy-saving mode.		
10-18	P.229	Dwell function selection	0: Off.	0	<a href="#">224</a>
			1: Backlash compensation function.		
			2: Acceleration and deceleration interrupt waiting function.		
10-19	P.230	Dwell frequency at acceleration	0 ~ 650.00Hz	1.00Hz	<a href="#">224</a>
10-20	P.231	Dwell time at acceleration	0 ~ 360.0s	0.5s	<a href="#">224</a>
10-21	P.232	Dwell frequency at deceleration	0 ~ 650.00Hz	1.00Hz	<a href="#">224</a>
10-22	P.233	Dwell time at deceleration	0 ~ 360.0s	0.5s	<a href="#">224</a>
10-23	P.234	Triangular wave function selection	0: Off.	0	<a href="#">225</a>
			1: If terminal function TRI is triggered, triangular wave function will on.		
			2: Triangular wave function is on at all time.		
10-24	P.235	Maximum amplitude	0 ~ 25.0%	10.0%	<a href="#">225</a>
10-25	P.236	Amplitude compensation at deceleration	0 ~ 50.0%	10.0%	<a href="#">225</a>
10-26	P.237	Amplitude compensation at acceleration	0 ~ 50.0%	10.0%	<a href="#">225</a>
10-27	P.238	Amplitude acceleration time	0 ~ 360.00s/0 ~ 3600.0s	10.00s	<a href="#">225</a>
10-28	P.239	Amplitude deceleration time	0 ~ 360.00s/0 ~ 3600.0s	10.00s	<a href="#">225</a>
10-29	P.247	Switch to commercial supply MC switchover interlock time	0.1 ~ 100.0s	1.0s	<a href="#">226</a>
10-30	P.248	Switch to commercial supply waiting time	0.1 ~ 100.0s	0.5s	<a href="#">226</a>
10-31	P.249	From inverter to commercial power supply switchover frequency	0 ~ 60.00Hz	99999	<a href="#">226</a>
			99999: Off.		

Group	Parameter Number	Name	Setting Range	Default	Page
10-32	P.250	Automatic switchover frequency range	0~10.00Hz: After switching from inverter operation to commercial power supply operation, after inverter start command (STF/STR) is OFF, switch to inverter operation.	99999	<a href="#">226</a>
			99999: After switching from inverter operation to commercial power supply operation, after inverter start command (STF/STR) is OFF, switch to inverter operation, and slow down to stop.		
10-33	P.273	When input power fail stop option	0: Off.	0	<a href="#">229</a>
			1: No undervoltage avoidance (If undervoltage or power fail, the motor decelerates to stop.)		
			2: No undervoltage avoidance (If undervoltage or power fail, the motor decelerates to stop. Motor re-accelerates if power restores during the deceleration to stop.)		
			11: Undervoltage avoidance (If undervoltage or power fail, the motor decelerates to stop.)		
			12: Undervoltage avoidance (If undervoltage or power fail, the motor decelerates to stop. Motor re-accelerates if power restores during the deceleration to stop.)		
10-34	P.274	When input power fail subtracted frequency at deceleration start	0 ~ 20.00Hz	3.00Hz	<a href="#">229</a>
10-35	P.275	When input power fail subtraction starting frequency	0 ~ 120.00Hz: When output frequency $\geq$ 10-35 (P.275) , Motor decelerates from “output frequency - 10-34(P.274)” ; When output frequency < 10-35 (P.275), deceleration from output frequency	50.00Hz	<a href="#">229</a>
			99999: Motor decelerates from “output frequency - 10-34(P.274)”		
10-36	P.276	Deceleration time during input power failure 1	0~360.00s/0~3600.0s	5.00s	<a href="#">229</a>
10-37	P.277	Deceleration time during input power failure 2	0~360.00s/0~3600.0s: Set deceleration time below the set frequency of 10-38 (P.278)	99999	<a href="#">229</a>
			99999: Set deceleration time to the set frequency of 10-38 (P.278)		
10-38	P.278	When input power fail deceleration time switchover frequency	0 ~ 650.00Hz	50.00Hz	<a href="#">229</a>
10-39	P.279	UV avoidance voltage gain	0 ~ 200.0%	100.0%	<a href="#">229</a>
10-40	P.700	VF separated voltage source	0: Given by digital 10-41(P.701).	0	<a href="#">231</a>
			1: Given by analog or HDI pulse signal.		
10-41	P.701	VF separated voltage digital	0 ~ 440.00V/0~220.00V	According to voltage	<a href="#">231</a>
10-42	P.702	VF separated voltage Acc time	0 ~ 1000.0s	0.0s	<a href="#">231</a>
10-43	P.703	VF separated voltage Dec time	0 ~ 1000.0s	0.0s	<a href="#">231</a>

Application parameter group 10

Group	Parameter Number	Name	Setting Range	Default	Page
10-44	P.704	VF separated stop selection	0: Frequency/voltage independently decreases to 0. 1: After the voltage decreases to 0, frequency decreases.	0	<a href="#">231</a>
10-45	P.267	Regeneration avoid function selection	0: Off. 1: Regeneration avoid function is always on. (Automatic calculate Acc/Dec speed ) 2: Regeneration avoid function is on only during constant speed operation (Automatic calculate Acc/Dec speed ) 11: Regeneration avoid function is always on. (Manual mode, Acc/Dec speed is set by 10-49(P.271) and 10-50(P.272)) 12: Regeneration avoid function is on only during constant speed operation (Manual mode, Acc/Dec speed is set by 10-49(P.271) and 10-50(P.272))	0	<a href="#">232</a>
10-46	P.268	Regeneration avoid action voltage level	220V : 155 ~ 400V 440V : 310 ~ 800V	380V 760V	<a href="#">232</a>
10-47	P.269	Regeneration avoid function DC bus voltage detection sensitivity at deceleration	0: Prevent regeneration avoidance from failing according to bus voltage change rate 1 ~ 5: Set the sensitivity to detect the bus voltage change rate. Larger number, higher sensitivity.	0	<a href="#">232</a>
10-48	P.270	Regeneration avoid frequency compensation value	0 ~ 10.00Hz: Set the limit value of regenerative avoid frequency compensation. 99999: Off.	6.00Hz	<a href="#">232</a>
10-49	P.271	Regeneration avoid voltage gain coefficient	0 ~ 400.0%/0 ~ 40.0%	100.0%	<a href="#">232</a>
10-50	P.272	Regeneration avoid frequency gain coefficient	0 ~ 400.0%/0 ~ 40.0%	100.0%	<a href="#">232</a>
10-51	P.264	Over excitation deceleration	0: Off. 1: Over excitation deceleration is valid.	0	<a href="#">233</a>
10-52	P.265	Over excitation current level	0 ~ 200.0%	150.0%	<a href="#">233</a>
10-53	P.266	Over excitation gain	1.00 ~ 1.40	1.10	<a href="#">233</a>
10-54	P.362	Short-circuit brake time when PM motor start	0~60.0s	0.0s	<a href="#">233</a>
10-55	P.780	PLC function selection	0: Off 1: PLC RUN signal from digital input terminal function 60 or 10-56 (P.781). 2 : PLC RUN signal from digital input terminal function 60	0	<a href="#">234</a>
10-56	P.781	PLC run	0: Off 1: PLC RUN	0	<a href="#">234</a>
10-57	P.782	PLC program erase function	0: Off 1: Erase the PLC program, after erase success parameter value is 0.	0	<a href="#">234</a>
10-58	P.783	PLC choose register to monitor	0~329	0	<a href="#">234</a>
10-59	P.784	PLC register monitoring value	Read only	Read	<a href="#">234</a>



## 5.11.1 DC injection brake

- When stopping the motor, apply DC voltage on motor to stop motor shaft from rotating, users can adjust the motor stop time and braking torque.

Parameter	Name	Default	Setting Range	Content
10-00 P.10	DC brake operating frequency	3.00Hz	0 ~ 120.00Hz	---
10-01 P.11	DC brake operating time	0.5s	0 ~ 60.0s	---
10-02 P.12	DC brake operating voltage	4.0%	0 ~ 30.0%	7.5K and below
		2.0%		11K ~ 22K

### Setting DC brake

- ◆ After sending stop signal (please refer to chapter 4 for basic operation of starting and stopping the motor), output frequency of inverter will gradually decrease. When the output frequency decreases to “DC brake operation frequency (10-00(P.10))”, DC brake will start to operate.
- ◆ During DC braking, inverter will inject DC voltage into the motor coil to lock the motor rotor. This voltage is called “DC brake operating voltage (10-02(P.12))”. The larger the 10-02(P.12) value, the greater the DC braking voltage, and the better the braking ability. However, the braking current will not exceed inverter rated current.
- ◆ Operation of DC braking will maintain a period of time (10-01(P.11) value) to overcome the inertia from motor rotation.
- ◆ See figure below:

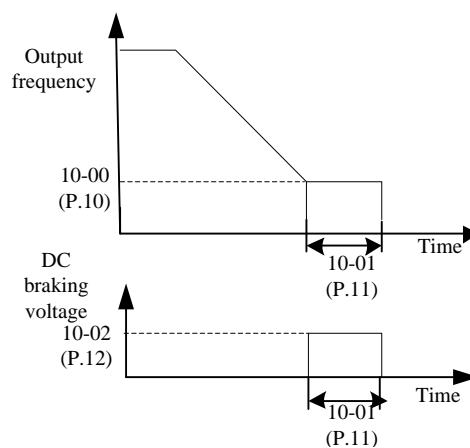

Note: 1. User must set appropriate values to get the best control characteristic.

2. If any one of 10-01(P.11), 10-02(P.12) is set to “0”, DC brake will not operate, when send stop signal, motor may still rotate due to inertia.

### 5.11.2 Zero-speed/zero-servo control

➤ Zero-speed/ zero-servo function selection

Parameter	Name	Default	Setting Range	Content
10-03 P.151	Zero-speed control function selection	0	0	Off.
			1	In close-loop vector control (00-21(P.300) /00-22(P. 370)=4) mode do zero-speed; In V/F close-loop control (00-21 (P.300) /00-22(P. 370) =1) mode do DC voltage breaking.
			2	In close-loop vector mode do zero-servo.
10-04 P.152	Voltage at zero-speed control	4.0%	0 ~ 30.0%	7.5K and types below
		2.0%		Types from 11K to 22K

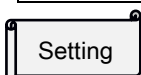

#### Zero-speed control

- ◆ Make sure to set 01-11(P.13) (start frequency) to zero when using this function.

Note: 1. If set 10-04(P. 152) to 6%, output voltage of zero speed is 6% of 01-04(P. 19) (base frequency voltage).  
 2. For V/F, V/F close-loop control, and close-loop vector control mode, please refer to the motor control mode parameter 00-21(P.300) ,00-22(P. 370).

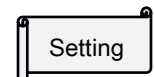

#### Zero servo

- ◆ Zero servo is closed loop position control, that can keep the motor stop at any position (origin) and lock the motor at a certain position while external force is applied.
- ◆ When zero servo is on, once the motor speed falls below 10-00(P. 10) value, inverter starts zero servo mode and holds the current position. When zero servo command is released and run command is given, the motor run again.
- ◆ Zero servo sequence diagram:

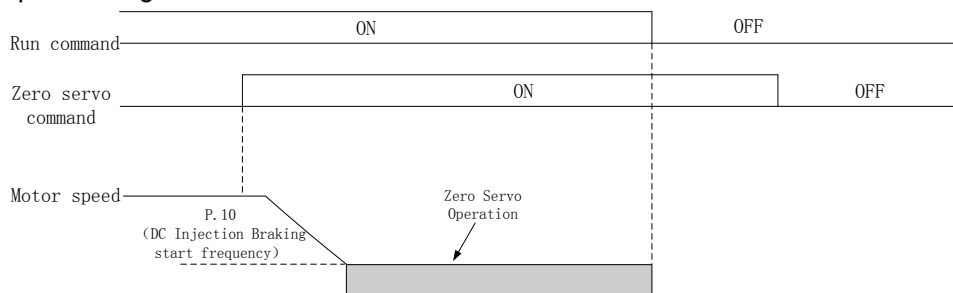

Note: Avoid using zero servo to lock 100% load for long period of time, this can cause failure. If need to lock motor for long periods, make sure the current is less than 50% of inverter rated current during zero servo, or use a larger capacity inverter.

## 5.11.3 DC injection brake before start

- **Before operation**, motor may be in rotating state due to external force or inertia. If inverter suddenly start operation, the output current may be too large, causing motor damage or trigger driver protection.

Parameter	Name	Default	Setting Range	Content
10-05 P.242	DC brake before inverter start	0	0	Off.
			1	Before starting operate DC brake first.
10-06 P.243	DC brake time before inverter start	0.5s	0 ~ 60.0s	---
10-07 P.244	DC brake voltage before inverter start	4.0%	0 ~ 30.0%	7.5K (included) and below
		2.0%		11K ~ 22K

Setting DC injection brake before start

- ◆ If 10-05(P. 242)=0, DC brake function before start will be off. If 10-05(P. 242)=1, DC brake before start is on, when inverter start, it will inject DC voltage (with 10-07(P. 244) value) into the motor coil to lock the rotor. DC brake will maintain for a period of time (10-06(P. 243) value) before motor starts to run.

See figure below:

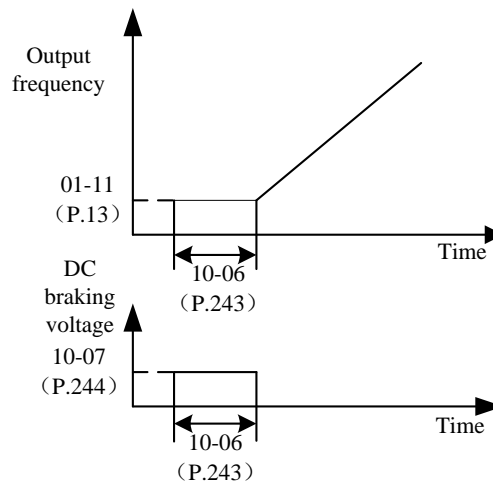

### 5.11.4 Restart mode selection

➤ Select suitable start mode according to different load conditions.

Parameter	Name	Default	Setting Range	Content
10-08 P.150	Restart mode selection	0	xx0	No frequency search.
			xx1	Direct frequency search
			xx2	Decrease voltage mode
			x0x	Power on once.
			x1x	Start each time.
			x2x	Only instantaneous stop and restart
			0xx	No rotation direction detection.
			1xx	Rotation direction detection.
			2xx	00-15(P.78)=0, rotation direction detection; 00-15(P.78)=1,2, no rotation direction detection.
10-09 P.57	Restart idling time	99999	0 ~ 30.0s	---
			99999	Off.
10-10 P.58	Restart rising time	5.0s	0 ~ 60.0s	7.5K (included) and types below.
		10.0s		11K ~ 22K types

#### Setting Restart mode selection

◆ 10-08(P.150) is set by 3 bits. The meaning of each bit is as follows:

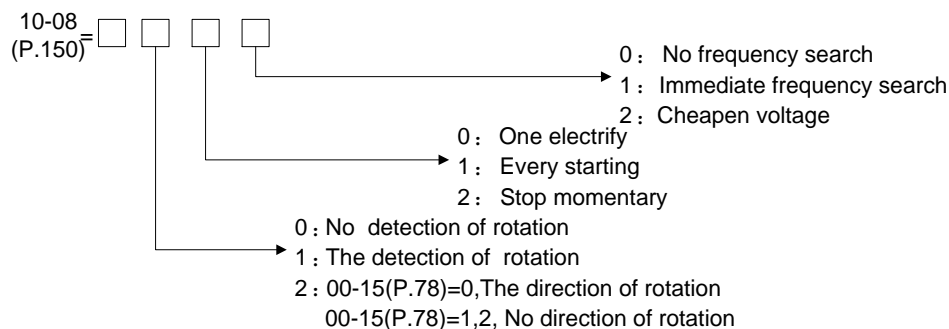

Note: 1. 10-08(P.150) must also be set if need instant restart function.

- If 10-08(P.150) is not 0, in default inverter do linear acceleration and deceleration.
- The direction detection bit of 10-08(P.150) is only valid for direct frequency search.
- This function is only valid in V/F control mode (00-21(P.300)=0).

#### Setting Restart function

- ◆ During motor operation, when instantaneous power interruption occur inverter will stop output immediately. If 10-09(P.57)=99999, inverter will not restart automatically after power is restored; If 10-09(P.57)=0.1~30, when power is restored, inverter will automatically restart the motor after idling for a period of time (10-09(P.57) value).
- ◆ When restarting the motor automatically, output frequency is target frequency, but output voltage is zero and then slowly rises to the proper voltage value. This voltage rise time is called "Restart rising time (10-10(P.58))".

◆ No frequency search restart operation

Restart operation will not care the free running speed of motor, but act according to the target frequency before the instantaneous stop, and slowly increasing the voltage.

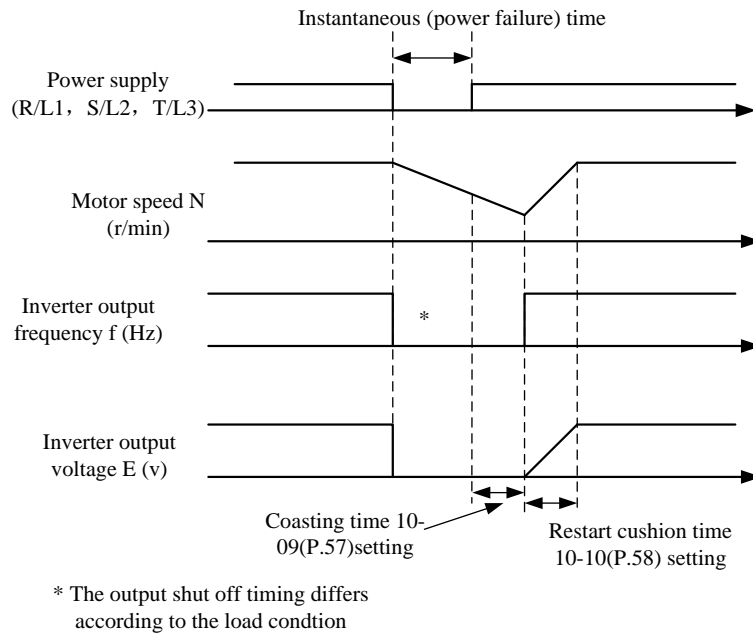

◆ Frequency search restart operation

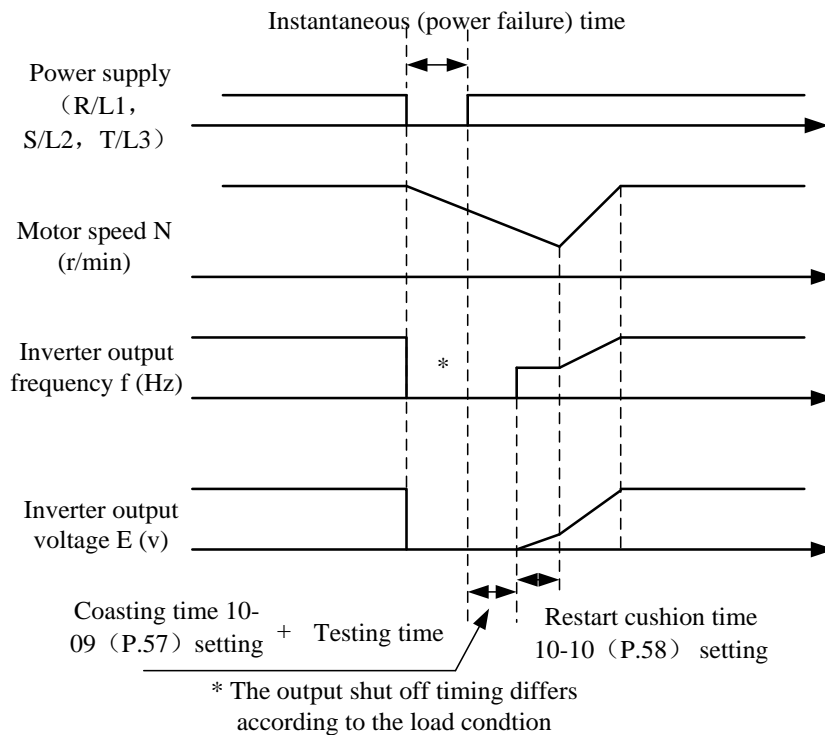

### 5.11.5 Remote setting function selection

- If operation box is located away from control cabinet, without analog signal, variable speed can still be realized through digital input

Parameter	Name	Default	Setting Range	Content
10-11 P.61	Remote control function	0	0	Off
			1	Remote control function, frequency save in memory
			2	Remote control function, frequency won't save
			3	Remote control function, frequency won't save, clear frequency setting every time STF/STR "turn off".
			X4	Remote control function, frequency save, the interval between two frequency memory time is not less than 5s
			1X	Target frequency range 01-01(P.2)~01-00(P.1). The target frequency comes from the setting during RH, RM operation.

Setting Remote setting function

In external mode, combined mode 1, combined mode 5, use digital input to change output frequency.

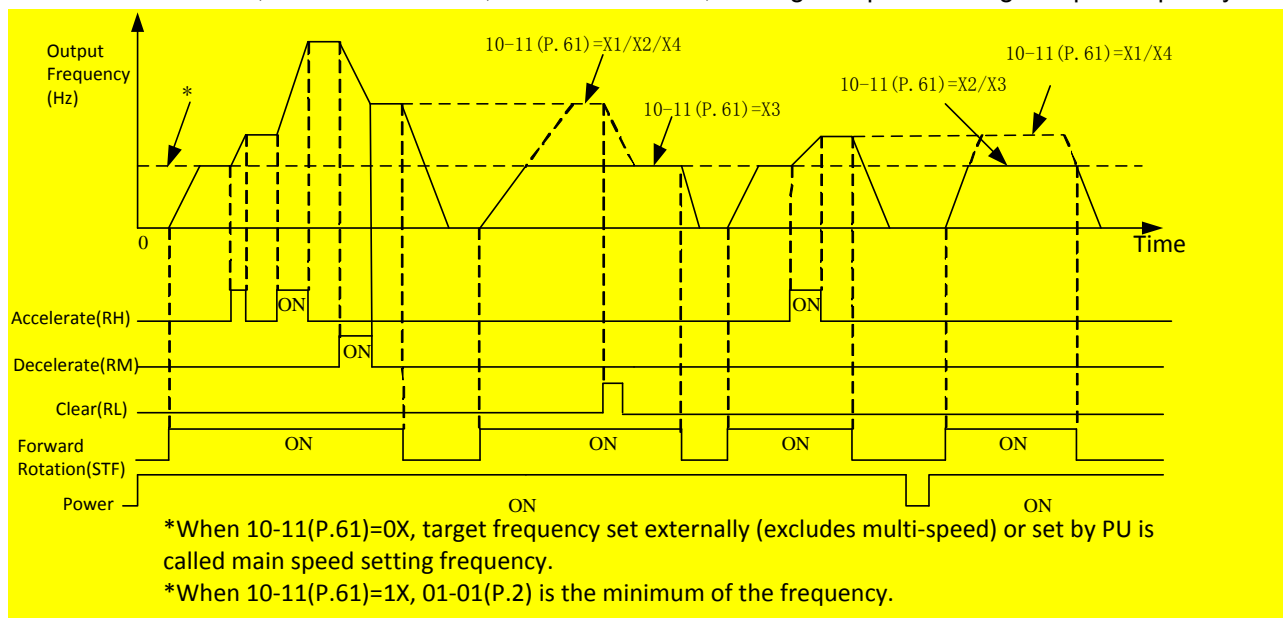

#### ◆ Remote function setting

- 10-11(P.61) decides remote function and ways to save frequency.

Set 10-11(P.61)=X1~X4, terminal RM, RH, RL will be accelerate (RH), decelerate (RM) and clear (RH). See following figure:

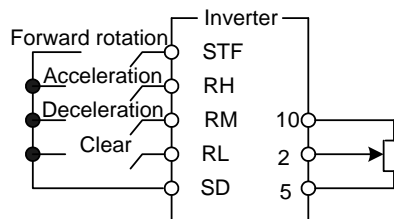

- If 10-11(P.61)=1~4, target frequency = (frequency set during RH, RM operation + externally set frequency other than multi-speed / frequency set in PU); if 10-11(P.61)=11~14, target frequency = frequency set during RH, RM operation.

◆ Frequency save

Frequency save function (10-11(P.61)=1) will save the frequency set by remote control (RH RM) into memory (EEPROM) every minute. Once power off and restart, output frequency start from the last saved frequency.

<Frequency save condition>

10-11(P.61) = X1

1. The frequency when starting signal (STF/STR) is "Off";
2. When RH (accelerate) and RM (decelerate) are both "Off", the frequency will be stored every minute. (Will not save if RL is On).

10-11(P.61) = X4

1. When RH (accelerate) and RM (decelerate) are both "Off", the frequency will be stored every 5 seconds. (Will not save if RL is On).

Note: 1. When 10-11(P.61) = 0X frequency can be controlled by RH (accelerate) and RM (decelerate) between 0 and (maximum frequency – frequency set by main speed). Output frequency is limited by 01-00(P.1).

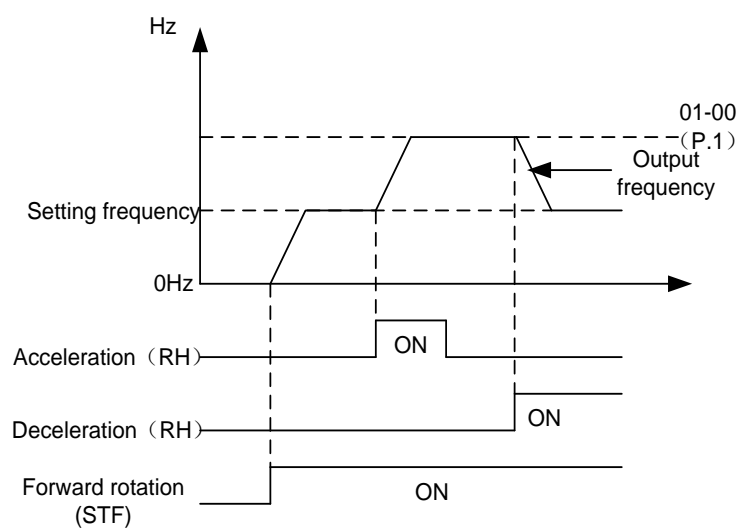

2. When 10-11 (P.61) = 1X, the adjustable frequency range through RH (acceleration) and RM (deceleration) is 01-01(P.2)~01-00(P.1), and output frequency is limit by 01-00 (P.1).

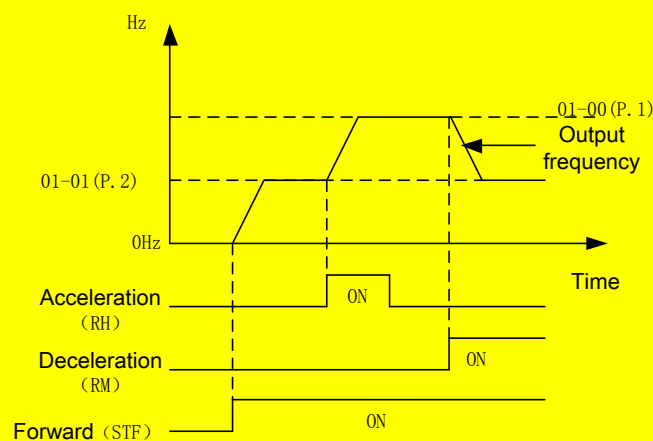

3. When acceleration/deceleration signal "on", acceleration/deceleration time is set by 01-40 (P.219).
4. When start signal (STF/STR) is Off and RH (accelerate) or RM (decelerate) is On, target frequency will also change.
5. If requires continuous frequency change, please turn off the frequency save function(10-11(P.61)=X2/X3). If set 10-11(P.61)=X1/X4, EEPROM lifetime will be shortened due to continuous writing.
6. RL, RM, RH mentioned in this section are the function names of the "multi-function digital input terminal". Please refer to 03-00~03-05(P.80~P.84、P.86) for function selection and purposes of the multi-function digital input terminal. For related wiring, please refer to [Section 3.7 Terminal wire arrangement](#).

## 5.11.6 Auto reset function

➤ This function allows inverter to reset itself and restart when alarm occurs. Choose which alarm to reset.

Parameter	Name	Default	Setting Range	Content
10-12 P.65	Auto reset function	0	0	Off.
			1	When over-voltage, inverter will reset.
			2	When over-current, inverter will reset.
			3	When either over-voltage or over-current, inverter will reset.
			4	When any alarm occur, inverter will reset.
10-13 P.67	Auto reset times	0	0	Off.
			1 ~ 10	If the alarm exceeds 10-13(P.67) times, inverter will not reset.
10-14 P.68	Auto reset waiting time	1.0s	0 ~ 360.0s	---
10-15 P.69	Auto reset times count	0	Read only	---

### Setting Auto reset function

- ◆ After alarm occur, inverter returns to the state before alarm, which is called “auto reset”.
- ◆ The auto reset of inverter is conditional. If alarm occurs and inverter auto reset, but the alarm occurs again within the time (10-14(P.68)\*5), then this type of alarm is called “continuous alarm”. If the continuous alarm exceeds a certain number of times, it means that there is a major fault, and this number is called “Auto reset times (10-13) (P.67)”. At this time, inverter will no longer perform auto reset, and need manual troubleshooting by user.
- ◆ If all alarms do not belong to “continuous alarm”, inverter can perform auto reset for an unlimited number of times.
- ◆ The time between the occurrence of alarm and auto reset is called “Auto reset waiting time 10-14 (P.68)”.
- ◆ For each auto reset, 10-15(P.69) value will automatically add 1. Therefore, 10-15(P.69) value read from memory represents the number of auto reset.
- ◆ If set parameter 10-15(P.69)=0, auto reset times can be cleared.

Note: The inverter will perform retry only after the retry waiting time of 10-14(P.68). Therefore when using this function, please be aware of the possible danger when operating the inverter.



## 5.11.7 Forward and reverse rotation dead time

- During the process of inverter output forward -reverse transition, set the transition time at 0Hz.

Parameter	Name	Default	Setting Range	Content
10-16 P.119	Forward and reverse rotation dead time	0.0s	0	Off.
			0.1~3000.0s	Waiting and holding time during forward -reverse switch, after inverter output frequency drops to zero

**Setting** Dead time of forward -reverse rotation

- ◆ Dead time of forward -reverse rotation refers to the waiting and holding time of inverter. During this period of time, inverter will transit from the current direction to the reverse direction upon receiving a reverse run command, and its output frequency will drop to zero.

The diagram is as follows:

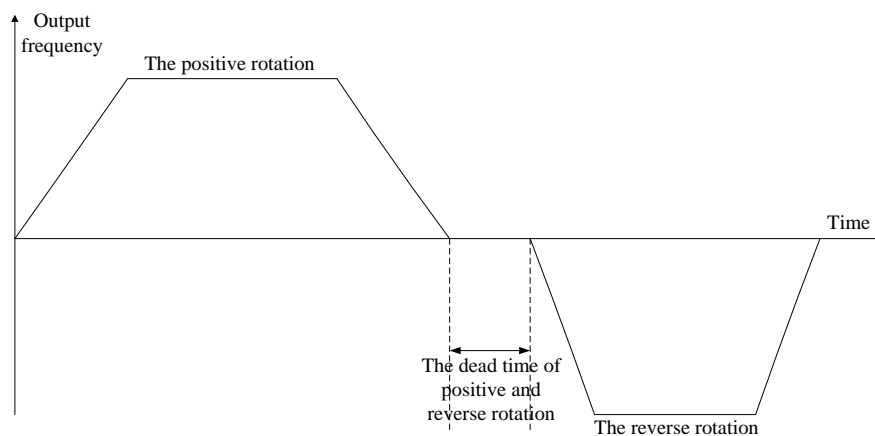

## 5.11.8 Energy-saving function V/F

- In energy-saving mode, in order to minimize inverter output power in constant speed operation, inverter will automatically control the output voltage.

Parameter	Name	Default	Setting Range	Content
10-17 P.159	Energy-saving control function	0	0	Off.
			1	Energy-saving mode.

**Setting** Energy-saving mode

- ◆ In energy-saving mode, in order to minimize inverter output power in constant speed operation, inverter will automatically control the output voltage.

Note: 1. This function is only valid in V/F mode (00-21(P.300)="0").

2. If selecting energy-saving operation mode, deceleration time may be longer than the set value. In addition, compared with constant torque load, overvoltage will more likely to occur, please set the deceleration time relatively longer.

3. For heavy-duty applications or frequent acceleration and deceleration machines, the energy saving effect may not be very good.

5.11.9 Dwell function V/F

- During acceleration /deceleration, this function can solve the backlash problem caused by stopping acceleration /deceleration, through frequency and time set by this parameters.

Parameter	Name	Default	Setting Range	Content
10-18 P.229	Dwell function selection	0	0	None.
			1	Backlash compensation function.
			2	Stop acceleration and deceleration waiting function.
10-19 P.230	Dwell frequency at acceleration	1.00Hz	0 ~ 650.00Hz	Set the stopping frequency and time of Dwell function during acceleration.
10-20 P.231	Dwell time at acceleration	0.5s	0 ~ 360.0s	
10-21 P.232	Dwell frequency at deceleration	1.00Hz	0 ~ 650.00Hz	Set the stopping frequency and time of Dwell function during deceleration.
10-22 P.233	Dwell time at deceleration	0.5s	0 ~ 360.0s	

Setting Dwell function

- ◆ Backlash compensation (10-18(P.229)="1")

The gears in reducer have backlash, and there is no-load segment between forward and reverse rotation. Even if the motor is running, the backlash will not produce a mechanical following status. In order to avoid backlash, acceleration and deceleration will be temporarily stopped. The frequency and time for interrupting acceleration and deceleration are set from 10-18(P.229)~10-22(P.233).

As shown in the following diagram:

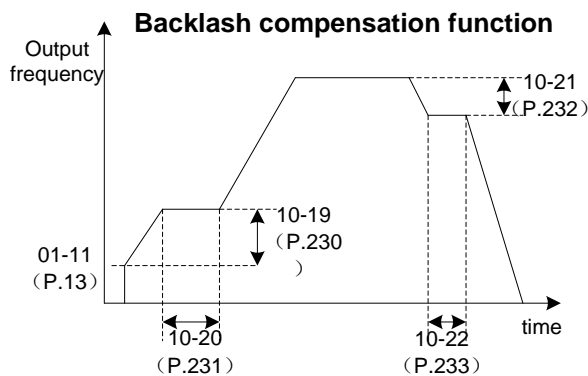

Note: After setting backlash compensation, only the interruption time in acceleration and deceleration time will become longer.

- ◆ Acceleration and deceleration interrupt waiting function (10-18(P.229)="2")

If 10-18(P.229)="2", acceleration/deceleration stop function is enabled. When accelerating to the frequency set in 10-19(P.230), accelerate to the target value after waiting for the time set in 10-20(P.231). When decelerating to the frequency set in 10-21(P.232), decelerate to the target value after waiting for the time set in 10-22(P.233).

As shown in the following diagram:

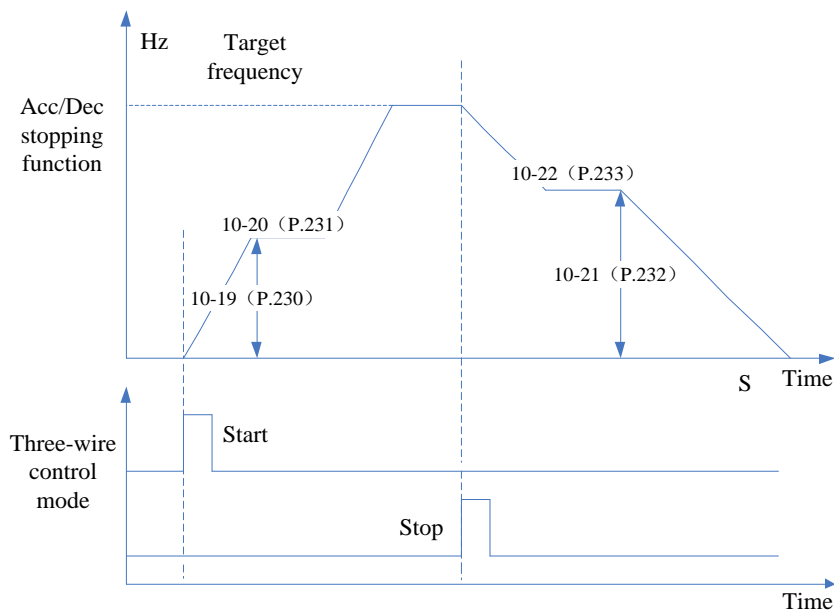

Note: After setting backlash compensation, only the interruption time in acceleration and deceleration time will become longer.

### 5.11.10 Triangular wave function V/F

➤ According to a certain period, through triangular wave makes output frequency oscillate.

Parameter	Name	Default	Setting Range	Content
10-23 P.234	Triangular wave function selection	0	0	Off
			1	If terminal function TRI is triggered, triangular wave function will on.
			2	Triangular wave function is on at all time.
10-24 P.235	Maximum amplitude	10.0%	0 ~ 25.0%	---
10-25 P.236	Amplitude compensation for deceleration	10.0%	0 ~ 50.0%	---
10-26 P.237	Amplitude compensation for acceleration	10.0%	0 ~ 50.0%	---
10-27 P.238	Amplitude acceleration time	10.00s	0 ~ 360.00s/ 0 ~ 3600.0s	When 01-08(P.21)=0, the unit of 10-27(P.238) and 10-28(P.239) is 0.01s.
10-28 P.239	Amplitude deceleration time	10.00s	0 ~ 360.00s/ 0 ~ 3600.0s	When 01-08(P.21)=1, the unit of 10-27(P.238) and 10-28(P.239) is 0.1s.

Setting Triangular wave function

- ◆ If 10-23(P.234) set to 1, triangular wave function will be on when terminal function TRI is triggered. Please set one of 03-00~03-05(P.80~P.84, P.86) as "36", and then give TRI signals to the digital input terminal.
- ◆ If 10-23(P.234) set to 2, triangular wave function will be on at any time.

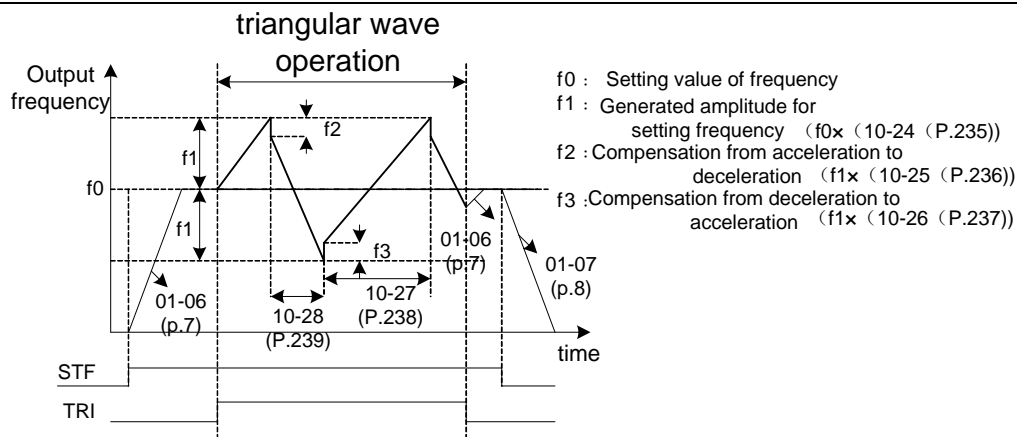

Note: 1. Output frequency is limited by the upper and lower frequency limits in triangular wave operation.  
 2. If the values of amplitude compensation 10-25(P.236) and 10-26(P.237), are too large, overvoltage trip and stall prevention protection will trigger.  
 3. This function is only valid in V/F mode (00-21(P.300)=0).

### 5.11.11 Switch to commercial power supply function

➤ Inverter has built-in switch to commercial power supply function. Magnetic contactor for switching can be conveniently used by inputting start, stop and automatic switching signal.

Parameter	Name	Default	Setting Range	Content
10-29 P.247	Switch to commercial supply MC switchover interlock time	1.0s	0.1 ~ 100.0s	---
10-30 P.248	Switch to commercial supply waiting time	0.5s	0.1 ~ 100.0s	---
10-31 P.249	From inverter to commercial power supply switchover frequency	99999	0 ~ 60.00Hz	---
			99999	Off
10-32 P.250	Automatic switchover frequency range	99999	0 ~ 10.00Hz	After switching from inverter operation to commercial power supply operation, after inverter start command (STF/STR) is OFF, switch to inverter operation.
			99999	After switching from inverter operation to commercial power supply operation, after inverter start command (STF/STR) is OFF, switch to inverter operation, and slow down to stop.

**Setting** Switch to commercial supply function

◆ 10-31(P.249) sets the frequency for switching from inverter operation to commercial supply. From start-up to 10-31(P.249) inverter operation, the output frequency is above 10-31(P.249) value, automatically switching to commercial supply. 10-31(P.249) set to 99999, without automatic switching.

- ◆ If 10-32(P.250)≠99999, 10-31(P.249)≠99999 will be valid at automatic switching operation. After switching from inverter operation to commercial supply, if frequency command is lower than (10-31(P.249)~10-32(P.250)), it will automatically switch to inverter operation and operate at the frequency of the frequency command. If the inverter start command (STF/STR) is set to OFF, it will also switch to inverter operation.
- ◆ If 10-32(P.250)=99999, 10-31(P.249)≠99999 will be valid at automatic switching operation. After switching from inverter operation to commercial supply, the inverter start command (STF/STR) will be set to OFF and then switch to inverter operation, and slow down to stop.
- ◆ Examples for commercial power supply frequency switchover function:

1. Set 03-03(P.80) = 37, 03-04(P.81) = 38, 03-10(P.40) = 10 and 03-11(P.85)= 9. The wiring diagram is presented below:

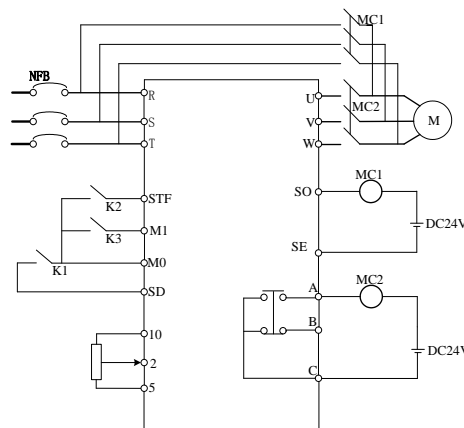

Terminals used are different according to the settings of 03-10(P.40), 03-11(P.85) (output terminal function selection). If selecting output terminal function 10, connect the relay driving commercial power supply, and if selecting output terminal function 9, then connect the relay driving frequency conversion. If selecting digital input terminal function 37, choose commercial power supply switching function; and if selecting digital input terminal function 38, choose the manual commercial power supply switching signal CS.

#### Warning:

1. MC1 and MC2 must be mechanically interlocked; the running direction of inverter operation and the commercial power supply operation should be consistent.
  2. Use the commercial power operation switchover function under external operation mode.
  3. STF/STR is valid when the CS signal is ON.
- ◆ Here are some typical sequence diagrams for the switchover of the commercial power supply frequency:
    1. No action sequence for the automatic switchover sequence (10-31(P.249) = 99999).

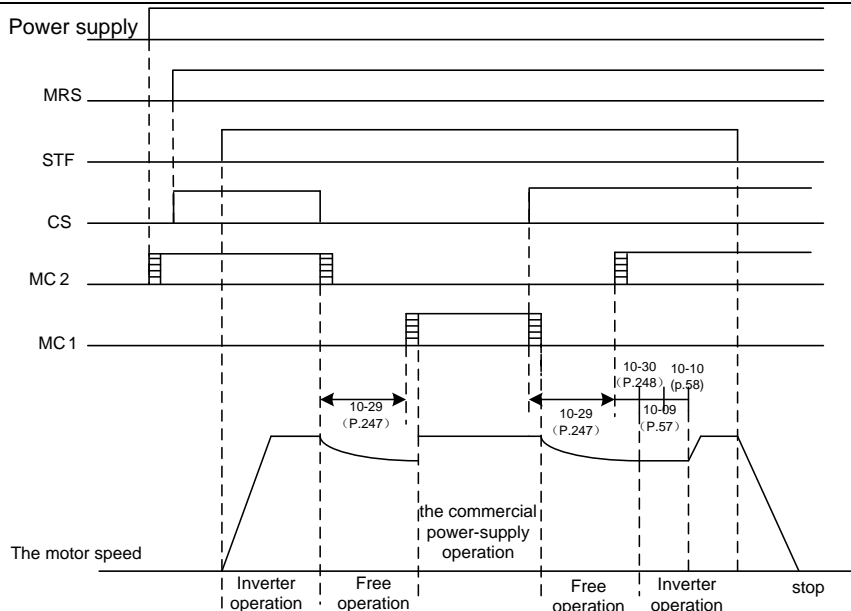

2. With action sequence for the automatic switchover sequence(10-31(P.249) ≠ 99999, 10-32(P.250) = 99999).

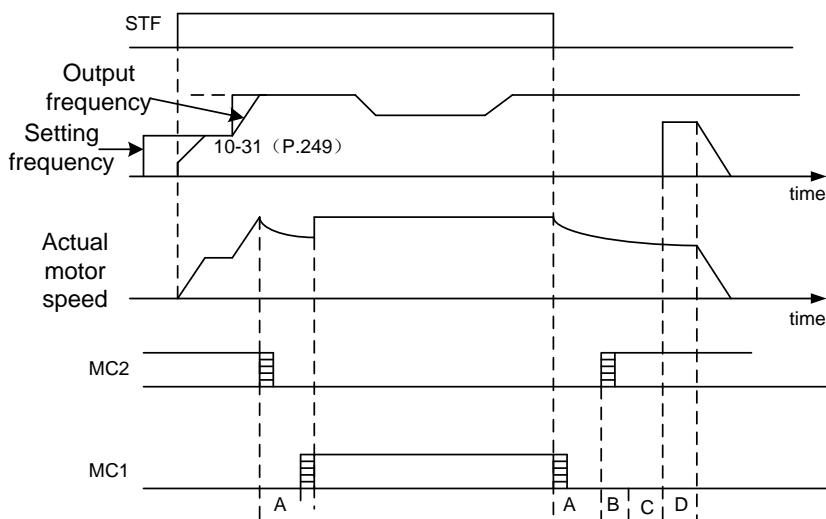

3. With action sequence for the automatic switchover sequence series (10-31(P.249)≠99999, 10-32(P.250)≠

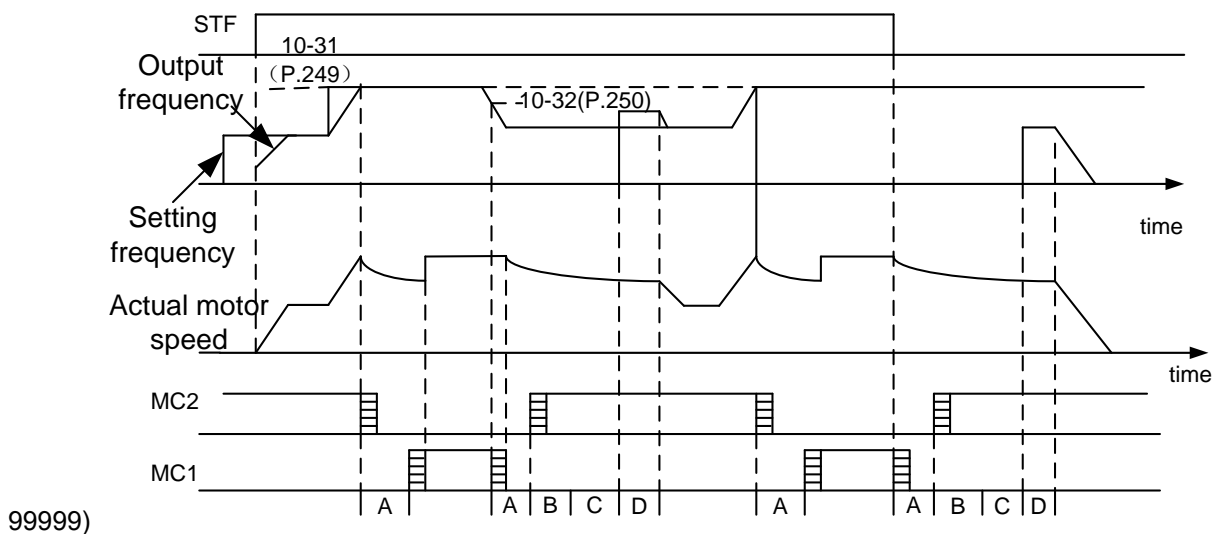

99999)

During the automatic switchover, A: 10-29(P.247) MC switchover interlocking time; B: 10-30(P.248) starting waiting time; C: 10-09(P.57) restarting free operation time; D: 10-10(P.58) restarting elevating time.

- Note: 1. When the motor runs at 50Hz (or 60Hz), the commercial power supply will offer a more efficient operation than the inverter will. Moreover, during the inverter maintenance/inspection period, the commercial power supply circuit should be installed to prevent the motor from being stopped for too long.
2. To prevent the inverter from setting off the over-current alarm when changing between the inverter operation and the commercial power supply operation, the interlock measure has to be taken. Once the motor stops, it will be activated via the inverter. Switchover and interlock can be carried out through the inverter and a complicated commercial power supply if commercial power supply switchover sequence function that can send out the signal for electromagnetic contactor actions is used.
3. This function is only valid under the V/F mode 00-21(P.300)=0.

### 5.11.12 When input power fail stop function

- When the inverter power comes to a sudden failure, regenerative power can maintain the inverter output to deceleration stop.

Parameter	Name	Default	Setting Range	Content
10-33 P.273	When input power fail stop option	0	0	Off.
			1	No undervoltage avoidance (If undervoltage or power fail, the motor decelerates to stop.)
			2	No undervoltage avoidance (If undervoltage or power fail, the motor decelerates to stop. Motor re-accelerates if power restores during the deceleration to stop.)
			11	Undervoltage avoidance (If undervoltage or power fail, the motor decelerates to stop.)
			12	Undervoltage avoidance (If undervoltage or power fail, the motor decelerates to stop. Motor re-accelerates if power restores during the deceleration to stop.)
10-34 P.274	When input power fail subtracted frequency at deceleration start	3.00Hz	0 ~ 20.00Hz	Normally it can run at the initial value, please adjust according to the load specification (inertia, torque)
10-35 P.275	When input power fail subtraction starting frequency	50.00Hz z	0 ~ 120.00Hz	When output frequency $\geq$ 10-35(P.275), Motor decelerates from "output frequency - 10-34(P.274)"; When output frequency < 10-35(P.275), deceleration from output frequency
			99999	Motor decelerates from "output frequency - 10-34(P.274)"
10-36 P.276	Deceleration time during input power failure 1	5.00s	0 ~ 360.00s/0 ~ 3600.00s	Set the time from the deceleration start to the 10-38(P.278) set frequency.
10-37 P.277	Deceleration time during input power failure 2	99999	0 ~ 360.00s/0 ~ 3600.00s	Set the deceleration time for the frequency range starting at 10-38(P.278) and downward.
			99999	Same as 10-36(P.276)
10-38 P.278	When input power fail deceleration time switchover frequency	50.00Hz z	0 ~ 650.00Hz	Set the frequency at which the slope during deceleration switches from the 10-36(P.276) setting to the 10-37(P.277) setting.
10-39 P.279	UV avoidance voltage gain	100.0%	0 ~ 200.0%	Adjust the response level for undervoltage avoidance operation.

Setting Power failure stop function

- ◆ When 10-33(P.273) is set to 1/11, (and 10-09=99999), inverter decelerates to a stop when input power fail; When 10-33(P.273) is set to 2/12, inverter decelerates to a stop when input power fail, and if during deceleration power comes back ON, inverter accelerates again.

Set 10-34(P.274) according to the value of load inertia. If load inertia is larger, then 10-34(P.274) should be set to a smaller value to produce enough regenerative power, usually 3.00Hz is enough.

Motor decelerates for the time set in 10-36(P.276). ( deceleration time is set to the time from 01-09(P.20) acceleration / deceleration reference frequency to stop.)

10-38(P.278) is the switch frequency between deceleration time during input power failure 1 and deceleration time during input power failure 2; If 10-37(P.277) is not set, motor will still decelerates for the time set to 10-36(P.276).

10-39(P.279) is UV avoidance voltage gain when 10-33(P.273) set to 11/12; if 10-33(P.273) is not set to 11/12, 10-39(P.279) is invalid.

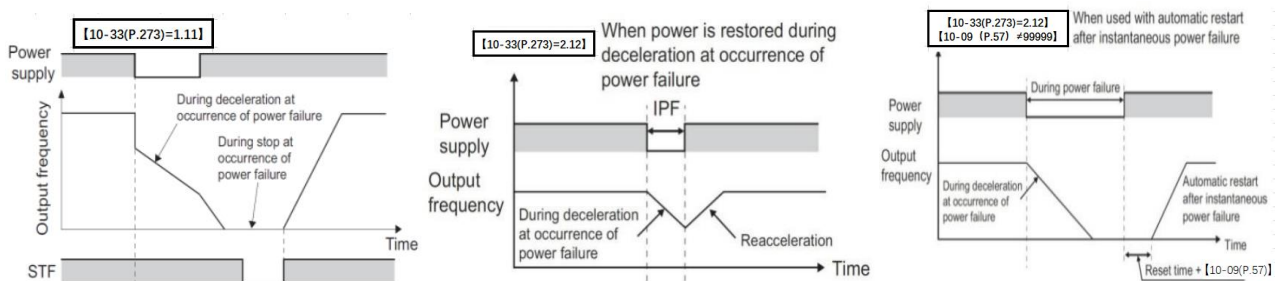

- ◆ Undervoltage avoidance function(10-33(P.273)=11/12):

When setting 10-33(P.273)=11/12, frequency is decreased to prevent an undervoltage from occurring during deceleration at input power fail.

Frequency drop trend and responsiveness can be adjusted by 10-39(P.279). If the set value is larger, the response to bus voltage changes will be better. However, if the load inertia is large, the regenerative energy will also be large, so 10-39(P.279) should be set smaller at this time.

Note: 1.This function is only for V/F control mode.  
2.This function won't work when using DC bus power supply



## 5.11.13 VF complete separation

- Voltage command given mode, voltage acceleration/deceleration time and voltage deceleration mode in VF complete separation.

Parameter	Name	Default	Setting Range	Content
10-40 P.700	VF separated voltage source	0	0	Given by digital 10-41(P.701).
			1	Given by analog or HDI pulse.
10-41 P.701	VF separated voltage digital	380/440V	0 ~ 440V	440V voltage
		220V	0 ~ 220V	220V voltage
10-42 P.702	VF separated voltage Acc time	0.0s	0 ~ 1000.0s	Time for voltage accelerating from 0 to motor rated voltage.
10-43 P.703	VF separated voltage Dec time	0.0s	0 ~ 1000.0s	Time for voltage decelerating from motor rated voltage to 0.
10-44 P.704	VF separated Stop selection	0	0	Frequency/voltage independently decreases to 0.
			1	After the voltage decreases to 0, frequency decreases.

## Setting VF complete separation

- ◆ Parameter 10-40(P.700)~10-44 (P.704) are valid only when 01-12(P.14)=14. VF complete separation is normally used in induction heating, inverse power supply and torque motor control.
- ◆ The voltage source for V/F complete separation is set in the same way as the frequency source, it can be set by digital or external analog terminal or HDI terminal.
- ◆ Frequency acceleration time of V/F complete separation indicates the time accelerates from 0 to base frequency (01-06(P.7)). Frequency deceleration time indicates the time decelerates from base frequency to 0 (01-07(P.8)); voltage acceleration time of VF complete separation indicates the time accelerates from 0 to the rated motor voltage  $t_1$  (10-42(P.702)). Voltage deceleration time of VF complete separation indicates the time decelerates from the rated motor voltage to 0  $t_2$  (10-43(P.703)).

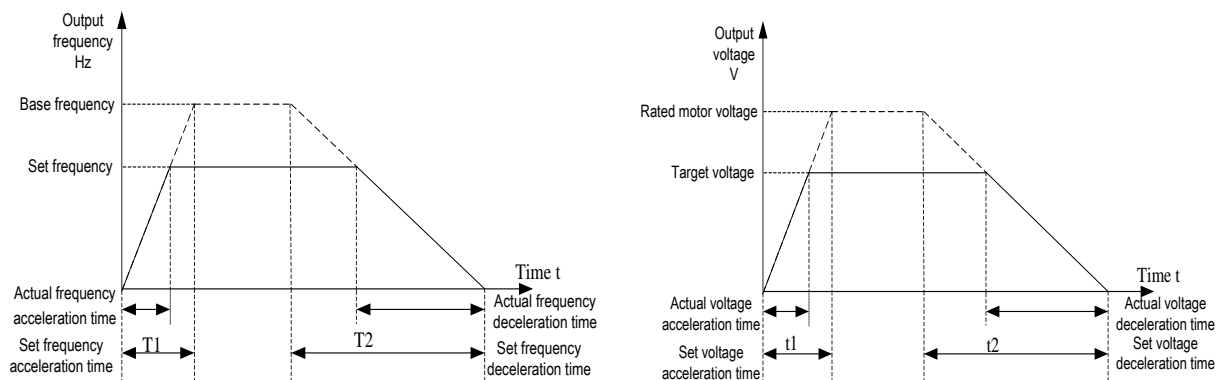

- ◆ Use 10-41(P.701) to set digital voltage, the setting value cannot exceed motor rated voltage.
- ◆ When voltage acceleration time is less than frequency acceleration time or voltage deceleration time is more than frequency deceleration time, voltage stall or current stall may occur during acceleration/ deceleration, which leads to alarm. So it is suggested that 10-42(P.702) > 01-06(P.7) and 10-43(P.703) < 01-07(P.8).

### 5.11.14 Regeneration and avoidance function

➤ When inverter load inertia is larger, during deceleration or other process PN voltage will increase due to regenerative power, and OV alarm will occur. This function can keep PN voltage fixed and prevent PN level from increasing to OV level by adjusting inverter output frequency and voltage.

Parameter	Name	Default	Setting Range	Content
10-45 P.267	Regeneration avoid function selection	0	0	Off.
			1	Regeneration avoid function is always on. (Automatic calculate Acc/Dec speed )
			2	Regeneration avoid function is on only during constant speed operation (Automatic calculate Acc/Dec speed )
			11	Regeneration avoid function is always on. (Manual mode, Acc/Dec speed is set by 10-49(P.271) and 10-50(P.272))
			12	Regeneration avoid function is on only during constant speed operation (Manual mode, Acc/Dec speed is set by 10-49(P.271) and 10-50(P.272))
10-46 P.268	Regeneration avoid action voltage level	380V	155 ~ 400V	220V models
		760V	310 ~ 800V	440V models
10-47 P.269	Regeneration avoid function DC bus voltage detection sensitivity at deceleration	0	0	Prevent regeneration avoidance from failing according to bus voltage change rate
			1 ~ 5	Set the sensitivity to detect the bus voltage change rate. Larger number, higher sensitivity.
10-48 P.270	Regeneration avoid frequency compensation value	6.00Hz	0 ~ 10.00Hz	Set the limit value of regenerative avoid frequency compensation.
			99999	Off.
10-49 P.271	Regeneration avoid voltage gain coefficient	100.0%	0 ~ 400.0%/0 ~ 40.0%	Setting range is related to 10-45 (P.267). If 10-45 (P.267) >10, the setting range is 0~40.00%; If 0-45 (P.267) <10, the setting range is 0-400.0%.
10-50 P.272	Regeneration avoid frequency gain coefficient	100.0%	0 ~ 400.0%/0 ~ 40.0%	Adjust the response speed during regeneration avoid operation. Increasing the set value will improve the response to the bus voltage changes, but output frequency may be unstable. If cannot reduced vibration even if 10-49 (P.271) is reduced, please reduce 10-50 (P.272).

**Setting** Regeneration and avoidance function

◆ Regeneration avoid function: In case too many regeneration energy in DC bus trigger inverter OV alarm. Regeneration avoid function will reduce bus voltage by increasing inverter output frequency when regeneration voltage exceeds the level, thus avoiding inverter from reporting OV alarm (as shown in the following diagram).

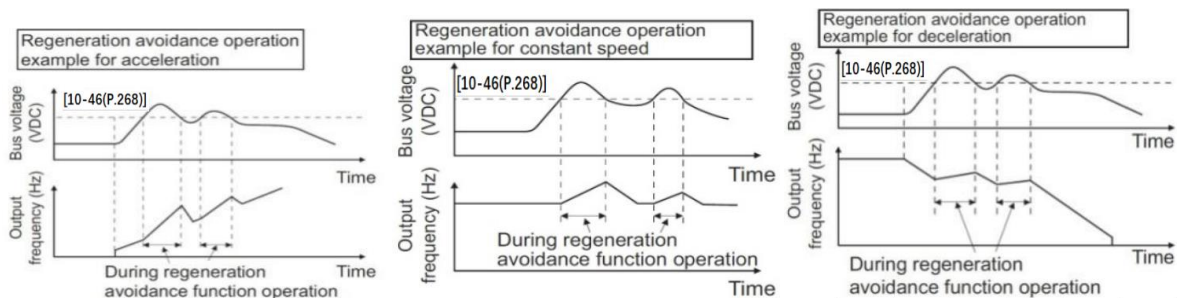

### 5.11.15 Over excitation deceleration function

- Over excitation deceleration function increases the energy consumption of motor by increasing the magnetic flux at deceleration and stop, which can shorten the deceleration time without braking resistor.

Parameter	Name	Default	Setting Range	Content
10-51 P.264	Over excitation deceleration	0	0	Off.
			1	Over excitation deceleration is on.
10-52 P.265	Over excitation current level	150.0%	0 ~ 200.0%	When output current is above the setting level in over excitation deceleration, over excitation gain will decrease automatically.
10-53 P.266	Over excitation gain	1.10	1.00 ~ 1.40	---

Setting Over excitation deceleration function

- ◆ Over excitation deceleration(10-51(P.264)=1)

Over excitation control can suppress the increasing of DC bus voltage. The larger over excitation gain is, the stronger suppressing effect is.

When voltage stall occurs in over excitation deceleration, it is necessary to prolong the deceleration time or increase the over excitation gain 10-53(P.266).

When current stall occurs in over excitation deceleration, it is necessary to prolong the deceleration time or decrease the over excitation gain 10-53(P.266).

Note: 1. As regenerative energy is mainly dissipated as heat in motor, motor temperature will rise if over excitation deceleration is applied frequently.

2. When a run command is given during over excitation deceleration, over excitation operation is cancelled and inverter will reaccelerate to command speed.

3. When PM motor is used, over excitation deceleration function is invalid.

### 5.11.16 Short-circuit brake function at PM motor start

- This parameter is used in open loop PM control. For motor control setting, please refer to 00-21(P.300) and 00-22(P.370).

Parameter	Name	Default	Setting Range	Content
10-54 P.362	Short-circuit brake time when PM motor start	0.0s	0.0 ~ 60.0s	---

- ◆ Sets the time for short-circuit brake operation when PM motor start. By shorting all three motor phases, it produces a braking torque in the motor and can be used to stop a free running motor before starting it again.

Note: Short Circuit Braking cannot prevent a PM motor from being rotated by an external force. To prevent the load from rotating the motor, use DC Injection.

## 5.11.17 Built-in PLC

## ➤ Setting of the parameters for the built-in PLC functions

Parameter	Name	Default	Setting Range	Content
10-55 P.780	PLC function selection	0	0	Off
			1	PLC RUN signal from digital input terminal function 60 or 10-56 (P.781)。
			2	PLC RUN signal from digital input terminal function 60
10-56 P.781	PLC run	0	0	Off
			1	PLC RUN
10-57 P.782	PLC program erase function	0	0	Off
			1	Erase the PLC program, after erase success parameter value is 0.
10-58 P.783	PLC choose register to monitor	0	0~329	PLC Component monitoring type selection
10-59 P.784	PLC register monitoring value	Read only	Read only	PLC Component state monitoring

Setting

Built-in PLC

- ◆ Select any terminal from digital input terminals M0, M1, M2, STF, STR, RES or terminals on expansion board EB362R, and set its corresponding function to PLC\_ON\_STOP (parameter setting value is 60). This sets PLC's RUN signal. Please refer to 5.4 for details of input terminals and expanded digital input terminals.

- ◆ PLC running status when 10-55(P.780)=1

10-56(P.781)	External PLC_ON_STOP signal	PLC state
0	0	STOP
1	0	RUN
0	1	RUN
1	1	RUN

- ◆ PLC running status when P.780=2

External PLC_ON_STOP signal	PLC state
0	STOP
1	RUN

- ◆ 10-58(P.783) selects PLC component for monitoring, and the value of 10-59(P.784) is the status of current monitoring PLC components, as shown in the following table.

10-58(P.783)	10-59(P.784)	10-58(P.783)	10-59(P.784)
1	X0~X17 (The name is in octal)	20	T0~T7 ( bit )
2	X20~X25 (The name is in octal)	21	C0~C7 ( bit )
3	Y0~Y17 (The name is in octal)	22	M8000~M8015
4	Y20~Y23 (The name is in octal)	23	M8016~M8031
5	M0~M15	24	M8032~M8047
6	M16~M31	25	M8048~M8063
7	M32~M47	26	M8064~M8079
8	M48~M63	27~52	keep
9	M64~M79	53~60	T0~T7 Set value (word)
10	M80~M95	61~68	keep
11	M96~M111	69~76	C0~C7 Set value
12	M112~M127	77~84	keep
13	M128~M143	85~92	T0~T7 Set value (word)
14	M144~M159	93~100	keep
15	M160~M175	101~108	C0~C7 Set value (word)
16	M176~M191	109~116	keep
17	M192~M207	117~164	D0~D47
18	M208~M223	165~326	D8000~D8161
19	M224~M239	327~329	keep

## 5.12 Speed and torque control parameter group 11

Group	Parameter Number	Name	Setting Range	Default	Page
11-00	P.320	Speed control proportional coefficient 1	0 ~ 200.0	10	<a href="#">237</a>
11-01	P.321	Speed control integral time 1	0 ~ 20.000s	0.50s	<a href="#">237</a>
11-02	P.322	PI coefficient switchover frequency 1	11-25 ( P.414 ) ~ 11-05 ( P.325 ) Hz	5.00Hz	<a href="#">237</a>
11-03	P.323	Speed control proportional coefficient 2	0 ~ 200.0	10	<a href="#">237</a>
11-04	P.324	Speed control integral time 2	0 ~ 20.000s	0.500s	<a href="#">237</a>
11-05	P.325	PI coefficient switchover frequency 2	11-02(P.322) ~ 650.00Hz	10.00	<a href="#">237</a>
11-06	P.326	Current control proportional coefficient	0 ~ 20	0	<a href="#">237</a>
11-07	P.327	PM motor type	0: SPM	0	<a href="#">238</a>
			1: IPM		
11-08	P.328	PM motor initial position detection method	0: Pull in.	0	<a href="#">238</a>
			1: High frequency pulse		
11-09	P.329	PM motor acceleration id	0 ~ 200%	80%	<a href="#">238</a>
11-10	P.330	PM motor constant speed id	0 ~ 200%	0%	<a href="#">238</a>
11-11	P.331	PM motor estimated speed filtering time	0 ~ 1000ms	2ms	<a href="#">238</a>
11-12	P.401	Torque command	-400.0 ~ 400.0%	0.0%	<a href="#">239</a>
11-13	P.402	Speed limit	-120% ~ 120%	0%	<a href="#">239</a>
11-14	P.403	Speed limit bias	0 ~ 120%	10%	<a href="#">239</a>
11-15	P.404	Torque filter time	0 ~ 1000ms	0ms	<a href="#">239</a>
11-16	P.405	Torque command source	0: Given by 11-12(P.401).	0	<a href="#">239</a>
			1: Given by analog or pulse input.		
			2: Given by communication mode.		
11-17	P.406	Speed limit selection	0: Speed is limited according to 11-13 (P.402) and 11-14 (P.403)	0	<a href="#">239</a>
			1: Frequency command source(it is decided according to 00-16(P.79) )		
11-18	P.407	Speed priority loop selection	0: Off	1	<a href="#">239</a>
			1: Turn on speed priority loop		
11-19	P.408	Forward-rotation electronic torque limit	0 ~ 400.0%	200.0%	<a href="#">241</a>
11-20	P.409	Reverse-rotation regenerative torque limit	0 ~ 400.0%	200.0%	<a href="#">241</a>
11-21	P.410	Reverse-rotation electronic torque limit	0 ~ 400.0%	200.0%	<a href="#">241</a>
11-22	P.411	Forward-rotation regenerative torque limit	0 ~ 400.0%	200.0%	<a href="#">241</a>
11-23	P.412	Zero-speed proportional coefficient	0~200.00	10.0	<a href="#">237</a>
11-24	P.413	Zero-speed integral time	0~20.000s	0.50s	<a href="#">237</a>
11-25	P.414	Zero-speed switching frequency	0~11-02(P.322)Hz	5.00Hz	<a href="#">237</a>
11-26	P.415	IM motor estimated speed filtering time	0-100.0ms	4.0ms	<a href="#">238</a>

Speed and torque control parameter group11

Group	Parameter Number	Name	Setting Range	Default	Page
11-30	P.371	Second motor speed control proportional coefficient 1	0 ~ 2000	10.0	<a href="#">242</a>
			99999		
11-31	P.372	Second motor speed control integral time 1	0 ~ 20.00s	0.50s	<a href="#">242</a>
			99999		
11-32	P.373	Second motor PI coefficient switchover frequency 1	0 ~ 11-35 (P.376)Hz	5.00Hz	<a href="#">242</a>
			99999		
11-33	P.374	Second motor speed control proportional coefficient 2	0 ~ 2000	10.0	<a href="#">242</a>
			99999		
11-34	P.375	Second motor speed control integral time 2	0 ~ 20.00s	0.50s	<a href="#">242</a>
			99999		
11-35	P.376	Second motor PI coefficient switchover frequency 2	11-32(P.373)~650.00Hz	10.00Hz	<a href="#">242</a>
			99999		
11-36	P.377	Second motor current control proportional coefficient	0 ~ 20	0	<a href="#">242</a>
			99999		
11-37	P.378	Second PM motor type	0: SPM	0	<a href="#">243</a>
			1: IPM		
			99999		
11-38	P.379	Second PM motor initial position detection method	0: Pull in.	0	<a href="#">243</a>
			1: High frequency pulse		
			99999		
11-39	P.380	Second PM motor acceleration id	0 ~ 200%	80%	<a href="#">243</a>
			99999		
11-40	P.381	Second PM motor constant speed id	0 ~ 200%	0%	<a href="#">243</a>
			99999		
11-41	P.382	Second PM motor estimated speed filtering time	0 ~ 1000ms	2ms	<a href="#">243</a>
			99999		
11-43	P.366	PM motor speed estimation observer Kp	0 ~ 65000	30	<a href="#">243</a>
11-44	P.367	PM motor speed estimation observer Ki	0 ~ 65000	10000	<a href="#">243</a>
11-48	P.387	Speed loop zero speed bandwidth	0~100.0Hz	5.0Hz	<a href="#">244</a>
11-49	P.388	Speed loop low speed bandwidth	0~100.0Hz	5.0Hz	<a href="#">244</a>
11-50	P.389	Speed loop high speed bandwidth	0~100.0Hz	5.0Hz	<a href="#">244</a>
11-51	P.390	Speed loop self-tuning selection	0: Off	0	<a href="#">244</a>
			1: Speed loop self-setting is effective		
11-52	P.368	Speed loop outputs low pass filter time constant	0~500.0ms	0.0ms	<a href="#">244</a>
11-58	P.440	PM motor id given low-pass filter time constant	0~65.535s	0.200s	<a href="#">254</a>

## 5.12.1 Control parameter

➤ When inverter runs in different frequencies, select and set different velocity loop PI parameters.

Parameter	Name	Default	Setting Range	Content
11-00 P.320	Speed control proportional coefficient 1	10.0	0 ~ 200.0	---
11-01 P.321	Speed control integral time 1	0.50s	0 ~ 20.000s	---
11-02 P.322	PI coefficient switchover frequency 1	5.00Hz	11-25 ( P.414 ) ~ 11-05 ( P.325 ) Hz	---
11-03 P.323	Speed control proportional coefficient 2	10.0	0 ~ 200.0	---
11-04 P.324	Speed control integral time 2	0.50s	0 ~ 20.000s	---
11-05 P.325	PI coefficient switchover frequency 2	5.00Hz	11-02(P.322) ~ 650.00Hz	---
11-06 P.326	Current control proportional coefficient	0	0 ~ 20	This parameter decides the response characteristics in IM motor torque control.
11-23 P.412	Zero-speed proportional coefficient	10.0	0~200.0	---
11-24 P.413	Zero-speed integral time	0.50s	0~20.000s	---
11-25 P.414	Zero-speed switching frequency	5.00Hz	0~11-02( P.322 )Hz	---

Setting Control parameter

- ◆ 11-00(P.320) and 11-01(P.321) are PI adjustment parameters when operating frequency is less than switching frequency 1 (11-02(P.322)), while 11-03(P.323) and 11-04(P.324) are PI adjustment parameters when the operating frequency is greater than switching frequency 2 (11-05(P.325)). The PI parameters of the frequency band between switching frequency 1 and switching frequency 2 are linear switching of two groups of PI parameters. As shown in the following diagram:

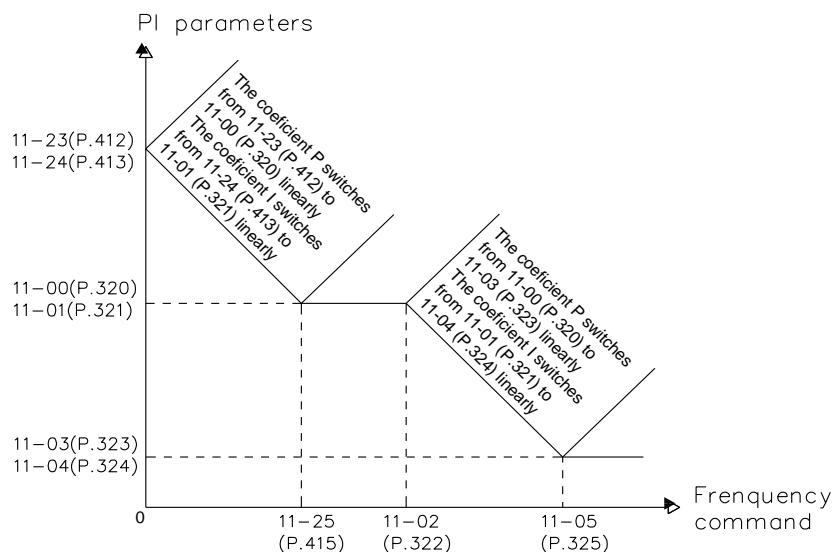

- ◆ 11-00(P.320) / 11-03(P.323) / 11-23(P.412) is used to set the proportion gain of speed control.(Set the value slightly larger to better follow changes on the speed reference and to reduce speed change due to external interference.)

## Speed and torque control parameter group11

- ◆ 11-01(P.321) / 11-04(P.324) / 11-24(P.413) is used to set the integral time of speed control.(Due to external interference-generated speed change, set the value smaller to shorten the time spent on returning to the original speed.)
- ◆ 11-06(P.326) Set the proportionality factor for IM motor current control (Set to a larger value and followability to the current command change will be better)

Note: 1. Increase 11-00(P.320) / 11-03(P.323) / 11-23(P.412) speed control gain can elevate response. But set too high can generate vibration and noises.

2. Reduce 11-01(P.321) / 11-04(P.324) / 11-24(P.413) speed control integral coefficient can shorten the time required to go back to the original speed. But if the value is too small, overshoot can happen.

3. When the setting value of 11-06(P.326) is increased, the response of the current regulator is improved, but if the setting value is too large, the current control will oscillate and there will be a large electromagnetic noise.

### 5.12.2 IM motor estimated speed filtering time

- Set the estimated low-pass filter time for the speed of the IM motor in sensorless vector control.

Parameter	Name	Default	Setting Range	Content
11-26 P.415	IM motor estimated speed filtering time	4ms	0 ~ 100.00ms	Only valid when 00-21(P.300)=3

Setting IM motor estimated speed filtering time

- ◆ When in sensorless vector control, if the motor control oscillates, 11-26 (P.415) can be properly adjusted, usually no setting is required.

### 5.12.3 PM motor setting

- The parameters setting below can improve the VC and SVC control characteristic of PM motor.

Parameter	Name	Default	Setting Range	Content
11-07 P.327	PM motor type	0	0	SPM
			1	IPM
11-08 P.328	PM motor initial position detection method	0	0	Pull in.
			1	High frequency pulse
11-09 P.329	PM motor acceleration id	80%	0 ~ 200%	id given at acceleration, valid only when 00-21=6
11-10 P.330	PM motor constant speed id	0%	0 ~ 200%	id given at constant speed, valid only when 00-21=6
11-11 P.331	PM motor estimated speed filtering time	2ms	0 ~ 1000ms	PM motor estimated rotation speed filter time constant, valid only when 00-21=6

Setting PM motor control setting

- ◆ 11-08(P.328) is used to select how the rotor position is detected at PM motor start. In PM motor close-loop vector control mode, inverter performs a magnetic pole search the first time it starts the motor. After that, rotor position is calculated from the PG encoder signal and saved until the inverter power is switched off.
- ◆ When 11-08(P.328)=0, detect initial magnetic pole position of the rotor by using pull-in method, the motor cannot start with heavy duty, or it may fail to start.



- ◆ When 11-08(P.328)=1, detect the initial magnetic pole position of the rotor by using high frequency pulse vibration method, electromagnetic noise may be generated from the motor at start.
- ◆ 11-09(P.329) is the current for pulling in the pole when PM motor starts. 05-05(P.306) (motor rated current) is set to 100%, setting the pull-in current during acceleration/deceleration, adjustments to this setting may help in the following situations:  
Increase this setting when a large amount of starting torque is required. Lower this setting if there is excessive current during acceleration.
- ◆ 11-10(P.330) is used to make the direction positioning for PM motor pole more effective during operation, the current for pulling in, 05-05(P.306) (the motor rated current) is set to 100%, set the d-axis current during operation at a constant speed. Please make adjustment in the following situations:  
Increase this setting when unstable due to offset during constant speed operation. If there is too much current when driving a normal load at a constant speed, then reduce this value.
- ◆ 11-11(P.331) is the PM motor speed observer filtering time constant, which usually does not need to be adjusted.

#### 5.12.4 Torque control parameter

- Used to select the inverter speed control or torque control.

Parameter	Name	Default	Setting Range	Content
11-12 P.401	Torque command	0.0%	-400.0 ~ 400.0%	Torque command
11-13 P.402	Speed limit	0.0%	-120% ~ 120%	Speed limit in torque control is valid when 11-17 (P.406) = 0. When it is set to 100%, the speed limit value will correspond to the setting value of 05-04 (P.305).
11-14 P.403	Speed limit bias	10%	0 ~ 120%	Bias value correspond to setting value of P.305 when it is set to 100%
11-15 P.404	Torque filter time	0ms	0 ~ 1000ms	Torque filter parameter
11-16 P.405	Torque command source	0	0	Given by 11-12(P.401).
			1	Given by analog or pulse input.
			2	Given by communication mode.
11-17 P.406	Speed limit selection	0	0	Speed is limited according to 11-13 (P.402) and 11-14 (P.403)
			1	Frequency command source(it is decided according to 00-16(P.79) )
11-18 P.407	Unidirectional speed limit bias	1	0	Off
			1	Unidirectional speed limit bias is valid.

#### Setting Torque control parameter

- ◆ 11-12(P.401) is used to set the torque command, actual torque command = 11-12(P.401)\* motor rated torque;

$$T(\text{N.M}) = \frac{P(\text{W})}{\omega(\text{rad/s})}$$

according to the motor rated torque formula:

$$P(\text{W}) \text{ is from } 05-01(\text{P.302}), \omega(\text{rad/s}) \text{ can be find according to parameter } 05-06(\text{P.307}): \frac{2\pi \times \text{P.307}}{60} (\text{rad/s})$$

## Speed and torque control parameter group11

### ◆ Input torque command polarity

Direction of motor output torque depends on the polarity of torque command and it has nothing to do with Run command. The following sheet shows the relationship between torque command, Run command, motor run direction and inverter run LED on keypad.

Item	Torque command		Run command	
	+	-	FWD	REV
Motor run direction	Forward	Reverse	Has nothing to do with run command	
Run LED on keypad	Has nothing to do with torque command direction and motor run direction		FWD LED on	REV LED on

◆ 11-15(P.404) is torque filter coefficient. When set larger, control will be stable, but response will be worse. When set too small, response will be quick, but control can be unstable. If don't know which value to set, adjust the value appropriately according to the level of unstable and response delay.

◆ When 11-16(P.405)=1, torque is given by analog or pulse input. Maximum value of analog and pulse correspond to motor rated torque. When 11-16(P.405)=2, torque is given by communication mode. There are two ways to set torque by communication mode, one is changing 11-12(P.401) value when 11-16(P.405) is set to 0, and another is by Modbus communication address H100D when 11-16(P.405) is set to 2. When Modbus communication address H100D is set to -10000~10000, it represents -100%~100% of the motor rated torque.

### ◆ Speed limit and speed limit bias of torque control

When 11-17(P.406)=0, limit speed in torque control according to 11-13(P.402) and 11-14(P.403); When 11-17(P.406)=1, limit speed in torque control according to frequency source, which is set by 00-16(P.79).

A bias can be added to speed limit using parameter 11-14(P.403) and parameter 11-18(P.407) determines how the speed limit bias is applied. The following sheet shows the setting relationship, and "frequency" in sheet refers to frequency command set by frequency source which is set by 00-16(P.79).

	Operating condition							
	Forward	Reverse	Forward	Reverse	Forward	Reverse	Forward	Reverse
Run command	Forward	Reverse	Forward	Reverse	Forward	Reverse	Forward	Reverse
Torque reference direction	+	+	-	-	+	+	-	-
Speed Limit direction	+	-	-	+	-	+	+	-
Normal operation direction	Forward		Reverse		Forward		Reverse	
Normal speed limit (11-18=0,11-17=0)	11-13 (P.402)+ 11-14 (P.403)	11-13 (P.402)+ 11-14 (P.403)	11-13 (P.402)+ 11-14 (P.403)	11-13 (P.402)+ 11-14 (P.403)	11-14 (P.403)	11-14 (P.403)	11-14 (P.403)	11-14 (P.403)
Normal speed limit (11-18=1,11-17=0)	11-13 (P.402)	11-13 (P.402)	11-13 (P.402)	11-13 (P.402)	11-14 (P.403)	11-14 (P.403)	11-14 (P.403)	11-14 (P.403)
Normal speed limit (11-18=0,11-17=1)	Frequency + 11-14 (P.403)	Frequency + 11-14 (P.403)	Frequency + 11-14 (P.403)	Frequency + 11-14 (P.403)	11-14 (P.403)	11-14 (P.403)	11-14 (P.403)	11-14 (P.403)
Normal speed limit (11-18=1,11-17=1)	Frequency	Frequency	Frequency	Frequency	11-14 (P.403)	11-14 (P.403)	11-14 (P.403)	11-14 (P.403)

## 5.12.5 Torque limit

- Set the torque limit values of the four quadrants via parameters.

Parameter	Name	Default	Setting Range	Content
11-19 P.408	Forward-rotation electronic torque limit	200.0%	0 ~ 400.0%	Set torque limit in first quadrant.
11-20 P.409	Reverse-rotation regenerative torque limit	200.0%	0 ~ 400.0%	Set torque limit in second quadrant.
11-21 P.410	Reverse-rotation electronic torque limit	200.0%	0 ~ 400.0%	Set torque limit in third quadrant.
11-22 P.411	Forward-rotation regenerative torque limit	200.0%	0 ~ 400.0%	Set torque limit in fourth quadrant.

Setting Four quadrants torque limit function

- ◆ 11-19(P.408)~11-22(P.411) are set to 100.0%, in vector control, inverter max output torque is the motor rated torque.

$$T(\text{N.M}) = \frac{P(\text{W})}{\omega(\text{rad/s})}$$

- ◆ Motor rated torque formula:  $T(\text{N.M}) = \frac{P(\text{W})}{\omega(\text{rad/s})}$ , P(W) is from 05-01(P.302),  $\omega(\text{rad/s})$  can be find according to parameter 05-06(P.307):  $\frac{2\pi \times P.307}{60}(\text{rad/s})$ .

- ◆ See the figure below for four quadrants torque limit:

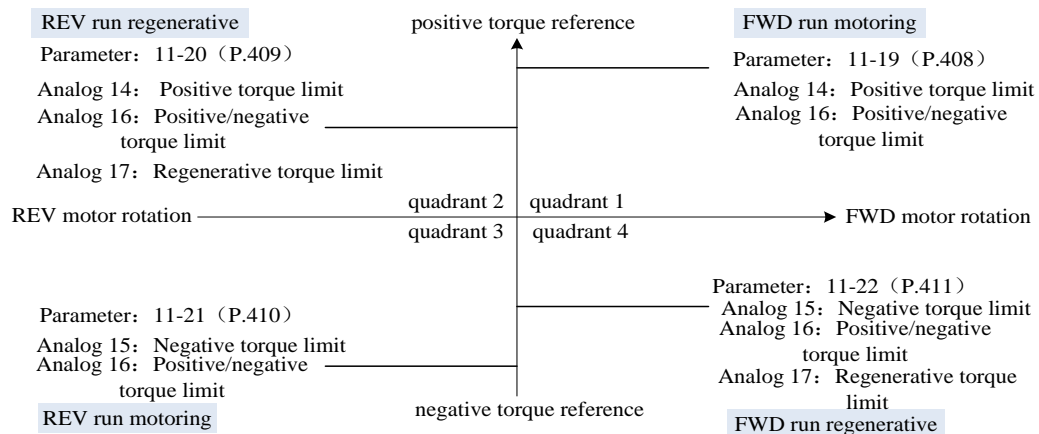

- ◆ Minimum torque limit is valid among torque limit set by parameter, torque limit set by analog and inverter output current limit set by 06-01(P.22).

## 5.12.6 Second motor control parameter

➤ Realize second motor function by setting second motor control parameter and digital input terminal.

Parameter	Name	Default	Setting Range	Content
11-30 P.371	Second motor speed control proportional coefficient 1	10.00	0 ~ 2000.0	---
			99999	
11-31 P.372	Second motor speed control integral time 1	0.500s	0 ~ 20.00s	---
			99999	
11-32 P.373	Second motor PI coefficient switchover frequency 1	5.00Hz	0 ~ 11-35 (P.376)Hz	---
			99999	
11-33 P.374	Second motor speed control proportional coefficient 2	10.00	0 ~ 2000.0	---
			99999	
11-34 P.375	Second motor speed control integral time 2	0.500s	0 ~ 20.00s	---
			99999	
11-35 P.376	Second motor PI coefficient switchover frequency 2	10.00Hz	11-32(P.373)~650 .00Hz	---
			99999	
11-36 P.377	Second motor current control proportional coefficient	0	0 ~ 20	---
			99999	

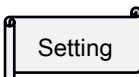
 Setting Second motor control parameter

◆ When 00-22(P. 370) ≠ 99999 and RT signal is ON, second motor control parameter 11-30(P.371)~11-36(P.377) are valid. For the second function parameter, please refer to Section 5.2.10.

◆ Please refer to section 5.6.4 Second motor parameter for more details.

◆ For the parameter setting, please refer to 11-00(P.320)~11-06(P.326) parameter function.

### 5.12.7 Second PM motor setting

- Realize second motor function by setting second motor control parameter and digital input terminal.

Parameter	Name	Default	Setting Range	Content
11-37 P.378	Second PM motor type	0	0	SPM
			1	IPM
			99999	---
11-38 P.379	Second PM motor initial position detection method	0	0	Pull in.
			1	High frequency pulse
			99999	---
11-39 P.380	Second PM motor acceleration id	80%	0 ~ 200%	---
			99999	
11-40 P.381	Second PM motor constant speed id	0%	0 ~ 200%	---
			99999	
11-41 P.382	Second PM motor estimated speed filtering time	2ms	0 ~ 1000ms	---
			99999	

#### Setting PM motor control parameter

- ◆ When 00-22(P. 370) ≠ 99999, and RT signal is ON, second motor control parameter 11-30(P.371)~11-36(P.377) are valid. For second function parameter, please refer to section 5.2.10.
- ◆ Please refer to section 5.6.4 Second motor parameter for more details.
- ◆ For setting, please refer to 11-07(P.327)~11-11(P.331) parameter function

### 5.12.8 PM motor speed estimation observer parameters

- By setting the PM motor speed estimation observer parameters, it can improve the stability of the PM motor in sensorless vector control mode.

Parameter	Name	Default	Setting Range	Content
11-43 P.366	PM motor speed estimation observer Kp	30	0 ~ 65000	---
11-44 P.367	PM motor speed estimation observer Ki	10000	0 ~ 65000	---

#### Setting PM motor speed estimation observer parameters

- ◆ Set PM motor in SVC (00-21(P.300) = 6), if motor run abnormal, users can manually adjust 11-43(P.366), 11-44(P.367), make PM motor SVC control operate stably.

### 5.12.9 PM Motor current loop controller parameters

➤ Adjust current loop responsiveness by setting PM current loop controller parameters.

Parameter	Name	Default	Setting Range	Content
11-48 P.387	Speed loop zero speed bandwidth	5.0Hz	0~100.0Hz	---
11-49 P.388	Speed loop low speed bandwidth	5.0Hz	0~100.0Hz	---
11-50 P.389	Speed loop high speed bandwidth	5.0Hz	0~100.0Hz	---
11-51 P.390	Speed loop self-tuning selection	0	0,1	Off
				Speed loop self-setting is effective

**Setting** PM Motor current loop controller parameters

- ◆ When 11-51(P.390) = 0, the speed loop PI parameters (11-00(P.320)、11-01(P.321)、11-03(P.323)、11-04(P.324)、11-23(P.412)、11-24(P.413)) are set manually;
- ◆ when 11-51(P.390) = 1, the speed The loop PI parameters (11-00(P.320)、11-01(P.321)、11-03(P.323)、11-04(P.324)、11-23(P.412)、11-24(P.413)) are automatically set, and with the reasonable setting of system inertia (05-17/05-18), Can achieve the ideal speed loop response characteristics; please adjust 11-48(P.387)、11-49(P.388)、11-50(P.389) respectively according to the responsiveness requirements. The larger the setting, the faster the speed loop response. If the setting is too large, it will cause system oscillation. We suggest increases 11-48(P.387)~11-50(P.389) slowly, and return to the previous setting value right after the system oscillates.

### 5.12.10 Velocity loop output low-pass filter time constant

➤ Set the low-pass filter time of the torque command output by the velocity loop

Parameter	Name	Default	Setting range	Content
11-52 P.368	Velocity loop output low-pass filter time constant	0ms	0~500.0ms	---

**Setting** Set velocity loop output low-pass filter time constant

If vibration is caused due to low mechanical rigidity, please gradually increase this value based on the increment of 1.0ms, usually not required to be set.

### 5.12.11 PM motor id given low-pass filter time constant

➤ Set the id given low-pass filter time of the PM motor in SVC mode

Parameter	Name	Default	Setting range	Content
11-58 P.440	PM motor id given low-pass filter time constant	0.200s	0~65.535s	---

**Setting** PM motor id given low-pass filter time constant

- ◆ In PM motor SVC mode, please increase the setting value when the motor load is light and the starting is unstable. If the load is heavy and PM motor stalls during starting acceleration, please reduce the setting value.

## 5.13 Position control parameter 12

Group	Parameter Number	Name	Setting Range	Default	Page
12-00	P.420	Homing mode	0 ~ 2123	0	<a href="#">247</a>
12-01	P.421	Homing,first high speed	0 ~ 650.00Hz	10.00Hz	<a href="#">247</a>
12-02	P.422	Homing,second high speed	0 ~ 650.00Hz	2.00Hz	<a href="#">247</a>
12-03	P.423	Pulse deviation of original point	-30000~30000	0	<a href="#">247</a>
12-04	P.424	Position command source	0: External pulse.	0	<a href="#">250</a>
			1: Relative position.		
			2: Absolute position.		
12-05	P.425	Position control proportional gain	0 ~ 65535	10	<a href="#">250</a>
12-06	P.426	Position control feed-forward gain coefficient	0 ~ 65535	0	<a href="#">250</a>
12-07	P.427	Position control feed-forward low pass filter time	0 ~ 65535ms	100ms	<a href="#">250</a>
12-08	P.428	External pulse position control speed limit	0 ~ 650.00Hz	10.00Hz	<a href="#">250</a>
12-09	P.429	Position reach margin	0 ~ 65535	40	<a href="#">250</a>
12-10	P.430	Zero servo gain	0 ~ 100	5	<a href="#">252</a>
12-11	P.431	Single point positioning	0~65535	0	<a href="#">252</a>
12-12	P.432	Single point positioning frequency	0~650.00Hz	0.00Hz	<a href="#">252</a>
12-13	P.433	Zero speed threshold	0~650.00Hz	0.50Hz	<a href="#">250</a>
12-14	P.434	Position command response option	0~2	0	<a href="#">250</a>
12-20	P.450	Cycle number of position command 1	-30000~30000	0	<a href="#">253</a>
12-21	P.451	Pulse number of position command 1	-30000~30000	0	<a href="#">253</a>
12-22	P.452	Cycle number of position command 2	-30000~30000	0	<a href="#">253</a>
12-23	P.453	Pulse number of position command 2	-30000~30000	0	<a href="#">253</a>
12-24	P.454	Cycle number of position command 3	-30000~30000	0	<a href="#">253</a>
12-25	P.455	Pulse number of position command 3	-30000~30000	0	<a href="#">253</a>
12-26	P.456	Cycle number of position command 4	-30000~30000	0	<a href="#">253</a>
12-27	P.457	Pulse number of position command 4	-30000~30000	0	<a href="#">253</a>
12-28	P.458	Cycle number of position command 5	-30000~30000	0	<a href="#">253</a>
12-29	P.459	Pulse number of position command 5	-30000~30000	0	<a href="#">253</a>
12-30	P.460	Cycle number of position command 6	-30000~30000	0	<a href="#">254</a>

Position control parameter12

Group	Parameter Number	Name	Setting Range	Default	Page
12-31	P.461	Pulse number of position command 6	-30000~30000	0	<u>254</u>
12-32	P.462	Cycle number of position command 7	-30000~30000	0	<u>254</u>
12-33	P.463	Pulse number of position command 7	-30000~30000	0	<u>254</u>
12-34	P.464	Cycle number of position command 8	-30000~30000	0	<u>254</u>
12-35	P.465	Pulse number of position command 8	-30000~30000	0	<u>254</u>
12-36	P.466	Cycle number of position command 9	-30000~30000	0	<u>254</u>
12-37	P.467	Pulse number of position command 9	-30000~30000	0	<u>254</u>
12-38	P.468	Cycle number of position command 10	-30000~30000	0	<u>254</u>
12-39	P.469	Pulse number of position command 10	-30000~30000	0	<u>254</u>
12-40	P.470	Cycle number of position command 11	-30000~30000	0	<u>254</u>
12-41	P.471	Pulse number of position command 11	-30000~30000	0	<u>254</u>
12-42	P.472	Cycle number of position command 12	-30000~30000	0	<u>254</u>
12-43	P.473	Pulse number of position command 12	-30000~30000	0	<u>254</u>
12-44	P.474	Cycle number of position command 13	-30000~30000	0	<u>254</u>
12-45	P.475	Pulse number of position command 13	-30000~30000	0	<u>254</u>
12-46	P.476	Cycle number of position command 14	-30000~30000	0	<u>254</u>
12-47	P.477	Pulse number of position command 14	-30000~30000	0	<u>254</u>
12-48	P.478	Cycle number of position command 15	-30000~30000	0	<u>254</u>
12-49	P.479	Pulse number of position command 15	-30000~30000	0	<u>254</u>



## 5.13.1 Homing mode

➤ Set original position of position control with homing function.

Parameter	Name	Default	Setting Range	Content				
12-00 P.420	Homing mode	0	0 ~ 2123	Homing mode setting: <table border="1" style="display: inline-table; vertical-align: middle;"> <tr> <td>u</td> <td>x</td> <td>y</td> <td>z</td> </tr> </table>	u	x	y	z
				u	x	y	z	
				u	0: Turn off homing mode 1: Execute homing mode automatically when power is on 2: Set terminal to SHOM function to initiate homing mode			
				x	0: After check, motor decelerates and returns to original point. 1: Motor stops according to forward direction after original point check			
y	0: Return to search for Z phase pulse when in homing mode 1: Search for Z phase pulse in homing mode without returning 2: In homing mode, locate searcher or Z phase pulse							
z	0: Forward spin return to original point, ORGP as original point 1: Reverse spin return to original point, ORGP as original point 2: Forward spin search for Z phase directly as returning point 3: Reverse spin search for Z phase directly as returning point							
12-01 P.421	First high speed of homing	10.00Hz	0 ~ 650.00Hz	---				
12-02 P.422	Second high speed of homing	2.00Hz	0 ~ 650.00Hz	---				
12-03 P.423	Original point deviation pulse number	0	-30000~30000	---				

**Setting** Homing mode

◆ Homing mode setting table(√ represents settable, × represents is unsettable)

y \ z	0	1	2	3
0	√	√	×	×
1	√	√	×	×
2	√	√	√	√

◆ If u=2、x=0 , The homing speed-position graph:

1.  $y=0, z=0$

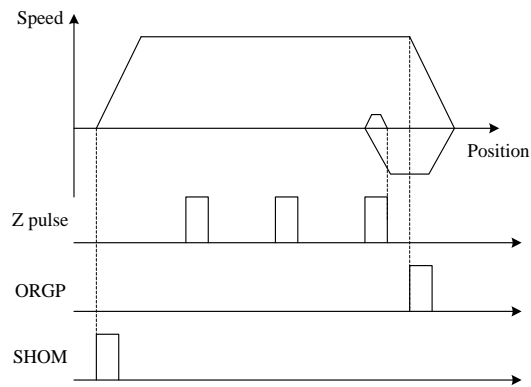

2.  $y=0, z=1$

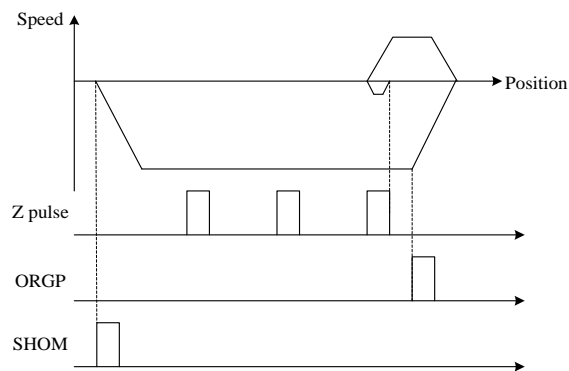

3.  $y=1, z=0$

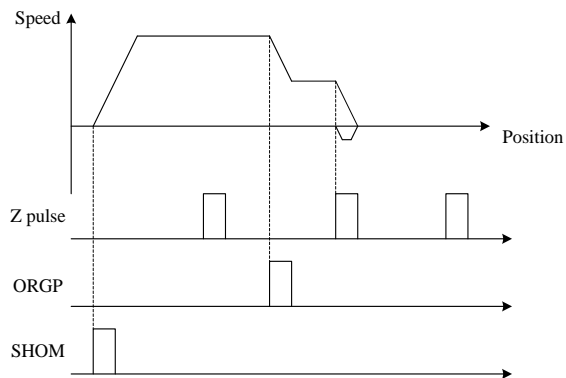

4.  $y=1, z=1$

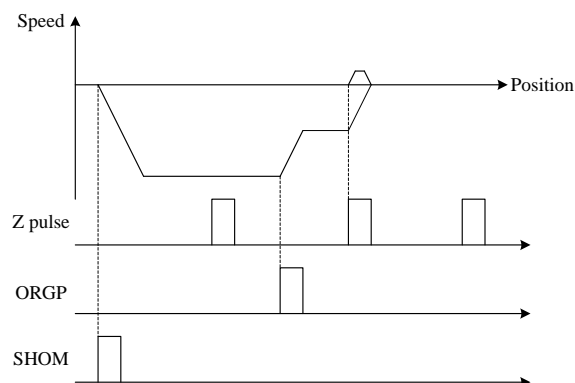

5.  $y=2, z=0$

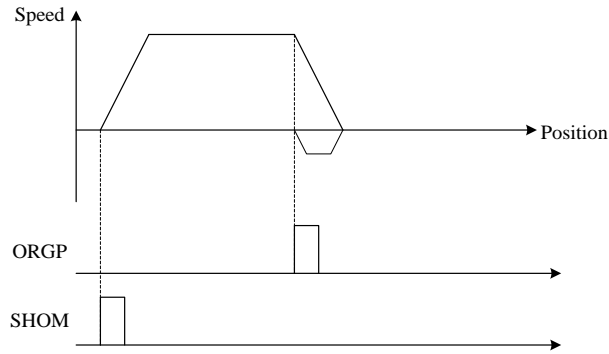

6.  $y=2, z=1$

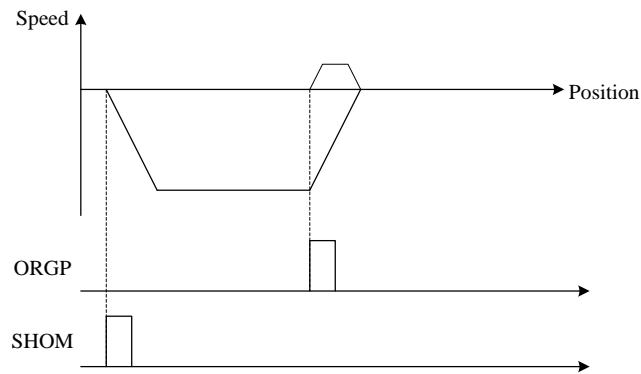

7.  $y=2, z=2$

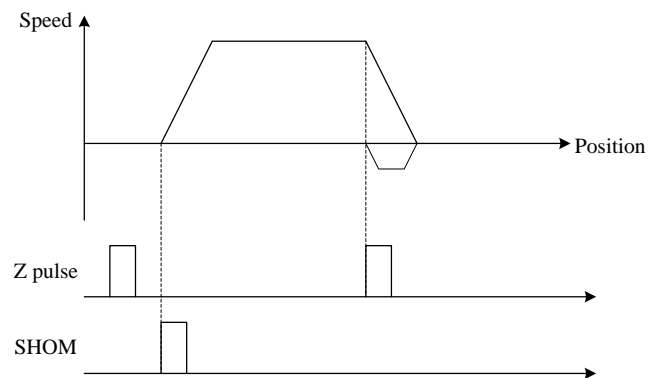

8.  $y=2, z=3$

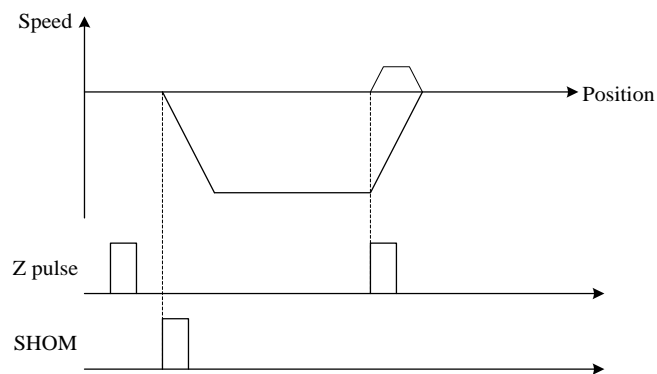

◆ Original point pulse offset : Set original point offset value according to forward spin direction of motor

### 5.13.2 Position control parameter

➤ Achieve accurate control function by setting with inverter via PG vector control mode.

Parameter	Name	Default	Setting Range	Content
12-04 P.424	Position command source	0	0	Position instruction source comes from external pulse.
			1	Position instruction source comes from the parameter (relative position).
			2	Position instruction source comes from the parameter (absolute position).
12-05 P.425	Position control ratio gain	10	0 ~ 65535	Increase setting can improve the response of position control, but may cause overshoot.
12-06 P.426	Position control feed forward gain	0	0 ~ 65535	Increase setting can improve the response of position control, but may cause overshoot.
12-07 P.427	Position control feed forward low pass filter time	100ms	0 ~ 65535ms	---
12-08 P.428	Control speed limit by external pulse	10.00Hz	0 ~ 650.00Hz	---
12-09 P.429	Margin when reaching position	40	0 ~ 65535	---
12-13 P.433	Zero speed threshold	0.50Hz	0~650.00Hz	---
12-14 P.434	Position command response option	0	0~2	---

**Setting** Position control function

- ◆ When 12-04(P.424)=0 ,position function is determined by pulse( refer to parameter 09-07(P.356) for encoder input type 2 )
- ◆ When 12-04(P.424)=1、 2 , position command is determined by parameter 12-20(P.450)~12-49(P.479) , relative position=1 , absolute position=2 , examples are as follow :

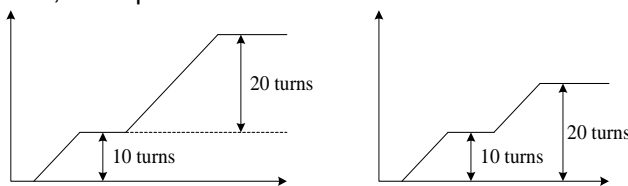

◆ Position control diagram

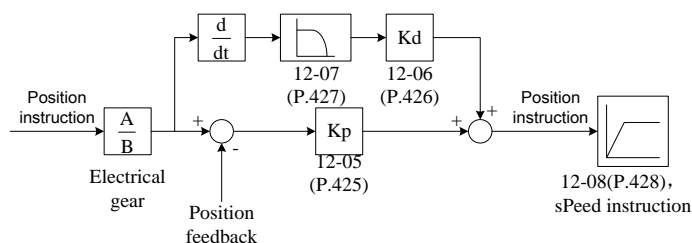

- ◆ When position command originates by parameter , the speed limit of position control is determined by multi speed command.When the multi-function input terminal is all 0 , it is determined by 12-08 ( P.428 ) .
- ◆ When the difference between the actual motor position and position command is smaller than the setting of position arrival margin12-09(P.429), it counts as arrival.If multi-function output terminal's function is set to 21, then signal is output.

- ◆ Zero speed threshold :When the actual revolution speed is slower than 12-13( P.433 ),multi-function input terminal ( position/speed switch ) is valid.

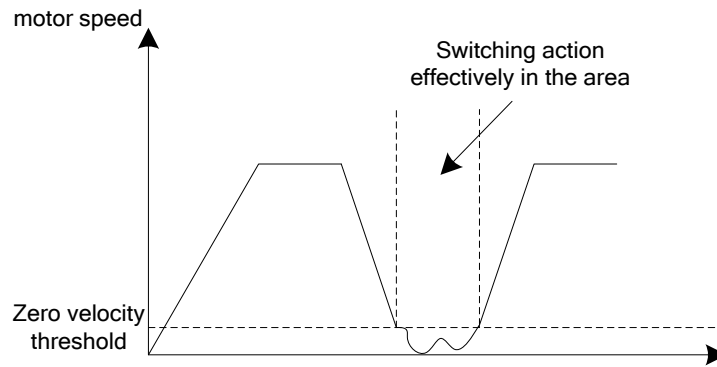

- ◆ Position command response  
Pr position mode, the position command response

The relative position 12-04 (P. 424) = 1:

12-14(P.434)=0:

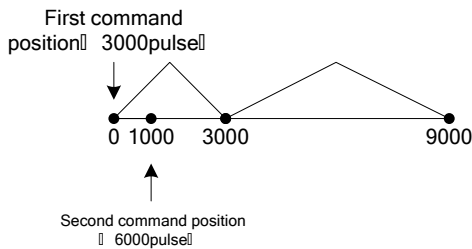

12-14(P.434)=1:

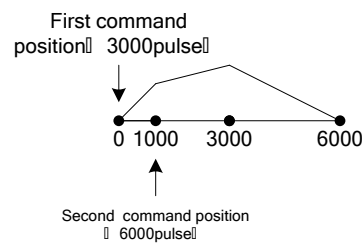

12-14(P.434)=2

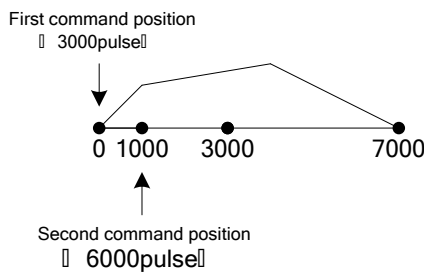

Absolute position 12-04 (P. 424) = 2:

12-14(P.434)=0:

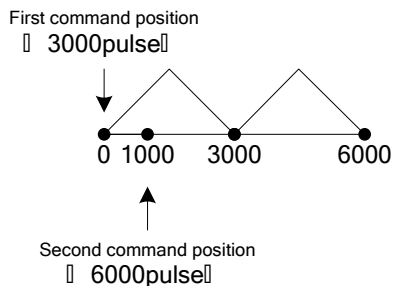

12-14(P.434)=1:

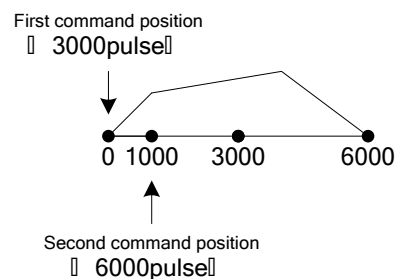

Note: 1.Refer to 03-10(P.40) , 03-11(P.85) for functions of digital output terminal.Refer to **section 3.7 Terminal wire arrangement.**

2.Refer to 03-00~03-05(P.80~P.84, P.86) for functions of digital input terminal.Refer to **section 3.7 Terminal wire arrangement.**

### 5.13.3 Zero servo

➤ Adjust the responsiveness of inverter zero servo by setting zero servo gain.

Parameter	Name	Default	Setting Range	Content
12-10 P.430	Zero servo gain	5	0 ~ 100	---

**Setting** Zero servo

◆ Refer to 12-10(P.430) for settings for responsiveness of zero servo. Increase value when irresponsive, load is applied, or the deviation of the starting position of zero servo is too large. If there is vibration when executing zero servo, decrease setting value.

### 5.13.4 Single point positioning function

➤ Single point positioning is a part of position control, but is independent from existing Pt, Pr in the program.

Parameter	Name	Default	Setting Range	Content
12-11 P.431	Single point positioning location	0	0~65535	---
12-12 P.432	Frequency of single point locating	0.00Hz	0~650.00Hz	---

**Setting** Single point positioning

◆ Single point positioning is a simple position control function achieved by using stopping angle of an embedded motor rotor as control function under speed control mode. The function is as shown in the following figures:

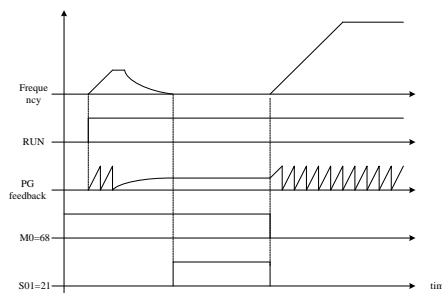

Figure 1.1 single point positioning on before operation

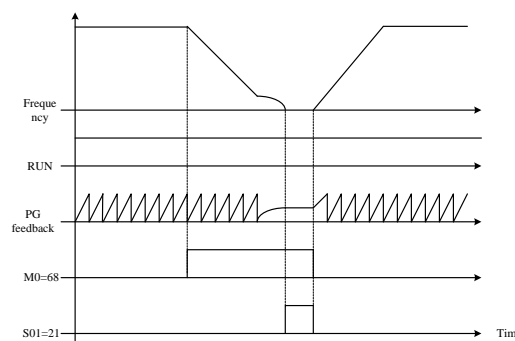

Figure 1.2 single point positioning on during operation

As shown in the above, the single point positioning function can be described as follows:

Under closed-loop speed mode , set external terminal function to single point positioning(03-03(P.80)=68 for instance).When terminal M0 is OFF, it is under pure speed mode, when terminal M0 is ON, Inverter goes from current functioning frequency to accelerate/decelerate curve, runs to positioning frequency(parameter 12-12(P.432)) , operates under said positioning frequency until Z phase is detected,switch to the position control which takes the value of 12-11(P.431) as target position, position control gain(12-05(P.425)) , arriving position output terminal and position margin (12-09 ( P.429 )) shares with position mode Pt, Pr.

### 5.13.5 Position command

- Set the position command of position control mode by digital input terminal.

Parameter	Name	Default	Setting Range	Content																																																																																																																																																							
12-20 P.450	Number of cycle position command 1	0	-30000~30000	<table border="1"> <thead> <tr> <th colspan="4">Terminal status</th> <th colspan="3">Target position</th> <th>frequency</th> </tr> <tr> <th>REX</th> <th>RH</th> <th>RM</th> <th>RL</th> <th colspan="3">(Number of cycle +pulse) *09-10(P.359)</th> <th>limit</th> </tr> </thead> <tbody> <tr> <td>0</td> <td>0</td> <td>0</td> <td>0</td> <td colspan="3"></td> <td>0</td> </tr> <tr> <td>0</td> <td>1</td> <td>0</td> <td>0</td> <td>Position1</td> <td>12-20</td> <td>12-21</td> <td>Speed 1</td> </tr> <tr> <td>0</td> <td>0</td> <td>1</td> <td>0</td> <td>Position2</td> <td>12-22</td> <td>12-23</td> <td>Speed 2</td> </tr> <tr> <td>0</td> <td>0</td> <td>0</td> <td>1</td> <td>Position3</td> <td>12-24</td> <td>12-25</td> <td>Speed 3</td> </tr> <tr> <td>0</td> <td>0</td> <td>1</td> <td>1</td> <td>Position4</td> <td>12-26</td> <td>12-27</td> <td>Speed 4</td> </tr> <tr> <td>0</td> <td>1</td> <td>0</td> <td>1</td> <td>Position5</td> <td>12-28</td> <td>12-29</td> <td>Speed 5</td> </tr> <tr> <td>0</td> <td>1</td> <td>1</td> <td>0</td> <td>Position6</td> <td>12-30</td> <td>12-31</td> <td>Speed 6</td> </tr> <tr> <td>0</td> <td>1</td> <td>1</td> <td>1</td> <td>Position7</td> <td>12-32</td> <td>12-33</td> <td>Speed 7</td> </tr> <tr> <td>1</td> <td>0</td> <td>0</td> <td>0</td> <td>Position8</td> <td>12-34</td> <td>12-35</td> <td>Speed 8</td> </tr> <tr> <td>1</td> <td>0</td> <td>0</td> <td>1</td> <td>Position9</td> <td>12-36</td> <td>12-37</td> <td>Speed 9</td> </tr> <tr> <td>1</td> <td>0</td> <td>1</td> <td>0</td> <td>Position10</td> <td>12-38</td> <td>12-39</td> <td>Speed 10</td> </tr> <tr> <td>1</td> <td>0</td> <td>1</td> <td>1</td> <td>Position11</td> <td>12-40</td> <td>12-41</td> <td>Speed 11</td> </tr> <tr> <td>1</td> <td>1</td> <td>0</td> <td>0</td> <td>Position12</td> <td>12-42</td> <td>12-43</td> <td>Speed 12</td> </tr> <tr> <td>1</td> <td>1</td> <td>0</td> <td>1</td> <td>Position13</td> <td>12-44</td> <td>12-45</td> <td>Speed 13</td> </tr> <tr> <td>1</td> <td>1</td> <td>1</td> <td>0</td> <td>Position14</td> <td>12-46</td> <td>12-47</td> <td>Speed 14</td> </tr> <tr> <td>1</td> <td>1</td> <td>1</td> <td>1</td> <td>Position15</td> <td>12-48</td> <td>12-49</td> <td>Speed 15</td> </tr> </tbody> </table>								Terminal status				Target position			frequency	REX	RH	RM	RL	(Number of cycle +pulse) *09-10(P.359)			limit	0	0	0	0				0	0	1	0	0	Position1	12-20	12-21	Speed 1	0	0	1	0	Position2	12-22	12-23	Speed 2	0	0	0	1	Position3	12-24	12-25	Speed 3	0	0	1	1	Position4	12-26	12-27	Speed 4	0	1	0	1	Position5	12-28	12-29	Speed 5	0	1	1	0	Position6	12-30	12-31	Speed 6	0	1	1	1	Position7	12-32	12-33	Speed 7	1	0	0	0	Position8	12-34	12-35	Speed 8	1	0	0	1	Position9	12-36	12-37	Speed 9	1	0	1	0	Position10	12-38	12-39	Speed 10	1	0	1	1	Position11	12-40	12-41	Speed 11	1	1	0	0	Position12	12-42	12-43	Speed 12	1	1	0	1	Position13	12-44	12-45	Speed 13	1	1	1	0	Position14	12-46	12-47	Speed 14	1	1	1	1	Position15	12-48	12-49	Speed 15
Terminal status												Target position			frequency																																																																																																																																												
REX	RH	RM	RL									(Number of cycle +pulse) *09-10(P.359)			limit																																																																																																																																												
0	0	0	0												0																																																																																																																																												
0	1	0	0									Position1	12-20	12-21	Speed 1																																																																																																																																												
0	0	1	0									Position2	12-22	12-23	Speed 2																																																																																																																																												
0	0	0	1									Position3	12-24	12-25	Speed 3																																																																																																																																												
0	0	1	1									Position4	12-26	12-27	Speed 4																																																																																																																																												
0	1	0	1									Position5	12-28	12-29	Speed 5																																																																																																																																												
0	1	1	0									Position6	12-30	12-31	Speed 6																																																																																																																																												
0	1	1	1									Position7	12-32	12-33	Speed 7																																																																																																																																												
1	0	0	0									Position8	12-34	12-35	Speed 8																																																																																																																																												
1	0	0	1									Position9	12-36	12-37	Speed 9																																																																																																																																												
1	0	1	0									Position10	12-38	12-39	Speed 10																																																																																																																																												
1	0	1	1									Position11	12-40	12-41	Speed 11																																																																																																																																												
1	1	0	0									Position12	12-42	12-43	Speed 12																																																																																																																																												
1	1	0	1									Position13	12-44	12-45	Speed 13																																																																																																																																												
1	1	1	0									Position14	12-46	12-47	Speed 14																																																																																																																																												
1	1	1	1									Position15	12-48	12-49	Speed 15																																																																																																																																												
12-21 P.451	Number of pulse of position command 1	0	-30000~30000																																																																																																																																																								
12-22 P.452	Number of cycle position command 2	0	-30000~30000																																																																																																																																																								
12-23 P.453	Number of pulse of position command 2	0	-30000~30000																																																																																																																																																								
12-24 P.454	Number of cycle position command 3	0	-30000~30000																																																																																																																																																								
12-25 P.455	Number of pulse of position command 3	0	-30000~30000																																																																																																																																																								
12-26 P.456	Number of cycle position command 4	0	-30000~30000																																																																																																																																																								
12-27 P.457	Number of pulse of position command 4	0	-30000~30000																																																																																																																																																								
12-28 P.458	Number of cycle position command 5	0	-30000~30000																																																																																																																																																								
12-29 P.459	Number of pulse of position command 5	0	-30000~30000																																																																																																																																																								

Position control parameter12

Parameter	Name	Default	Setting Range	Content
12-30 P.460	Number of cycle position command 6	0	-30000~30000	Same as 12-20 (P.450)
12-31 P.461	Number of pulse of position command 6	0	-30000~30000	
12-32 P.462	Number of cycle position command 7	0	-30000~30000	
12-33 P.463	Number of pulse of position command 7	0	-30000~30000	
12-34 P.464	Number of cycle position command 8	0	-30000~30000	
12-35 P.465	Number of pulse of position command 8	0	-30000~30000	
12-36 P.466	Number of cycle position command 9	0	-30000~30000	
12-37 P.467	Number of pulse of position command 9	0	-30000~30000	
12-38 P.468	Number of cycle position command 10	0	-30000~30000	
12-39 P.469	Number of pulse of position command 10	0	-30000~30000	
12-40 P.470	Number of pulse of position command 11	0	-30000~30000	---
12-41 P.471	Number of pulse of position command 11	0	-30000~30000	---
12-42 P.472	Number of pulse of position command 12	0	-30000~30000	---
12-43 P.473	Number of pulse of position command 12	0	-30000~30000	---
12-44 P.474	Number of pulse of position command 13	0	-30000~30000	---
12-45 P.475	Number of pulse of position command 13	0	-30000~30000	---
12-46 P.476	Number of pulse of position command 14	0	-30000~30000	---
12-47 P.477	Number of pulse of position command 14	0	-30000~30000	---
12-48 P.478	Number of pulse of position command 15	0	-30000~30000	---
12-49 P.479	Number of pulse of position command 15	0	-30000~30000	---



Setting	Position command
---------	------------------

- ◆ When 12-04(P.424) is 1,2,set terminal function to REX, RH, RM, RL. Position command is determined by both parameter and input terminal.
- ◆ Position command accelerate/decelerate time is determined by 01-06(P.7)、 01-07(P.8).
- ◆ Position command is determined by the position control of the parameter.The spinning direction of the motor is determined by both forward/ reverse spin and position command.Target position and parameter 09-02(P.351) is related to encoder input mode 1.

Example :

If setting 09-01(P.350)=1024 , encoder pulse value 1 is 1024.If 12-20(P.450)=1 , position command 1's number of spin is 1.If 12-21(P.451)=1024 , position command 1's pulse number is 1024.

If 09-02(P.351) is 1 or 2 , and encoder input type 1 is A/B phase pulse wave , then position command is 1+1/4 spins.

If 09-02(P.351) is 3 or 4 , and encoder input type 1 is :A phase as pulse train , and B phase as direction sign , then position command is 1 spin+1 spin.

Note: RL、 RM、 RH、 REX mentioned in this section is the function of 「Multi-function digital input terminal」 .About the functions of the multi-function digital input terminal , please refer to 03-00~03-05(P.80~P.84、 P.86).For wiring , please refer to **section 3.7 Terminal wire arrangement**.

## 5.14 Special adjustment parameter group 13

Group	Parameter Number	Name	Setting Range	Default	Page
13-00	P.89	Slip compensation coefficient	0 ~ 10	0	<u>256</u>
13-01	P.246	Modulation coefficient	0.90 ~ 1.20	1.00	<u>256</u>
13-02	P.285	Low frequency vibration suppression factor	0 ~ 8	5	<u>257</u>
13-03	P.286	High frequency vibration suppression factor	XX00 ~ XX15	509	<u>257</u>
			00XX ~ 15XX		
<b>13-05</b>	<b>P.216</b>	<b>Acceleration torque boost</b>	<b>-60.0 ~ 60.0%</b>	<b>0.0%</b>	<b><u>257</u></b>

## 5.14.1 Slip compensation V/F

- This parameter can set the compensation frequency and make the running speed of the motor at the rated current is closer to the set running speed, thus improving the accuracy of speed control.

Parameter	Name	Default	Setting Range	Content
13-00 P.89	Slip compensation coefficient	0	0 ~ 10	0: Off. 10: The compensation value is 3% of the target frequency.

Note: 1. This function is only valid in V/F mode (**00-21(P.300)="0"**).

2. At the process of slip compensation, the output frequency may be larger than the set frequency

## 5.14.2 Modulation coefficient

- It is used to determine the ratio of the maximum output voltage to the input voltage.

Parameter	Name	Default	Setting Range	Content
13-01 P.246	Modulation coefficient	1.00	0.90 ~ 1.20	Maximum output voltage = <b>13-01(P.246)</b> × input voltage

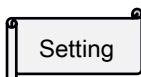
 Modulation coefficient

- ◆ This parameter can be used to obtain the maximum output voltage higher than the input voltage.
- ◆ However, if the set value is higher, the waveform of the output voltage will be distorted and contain harmonic waves, thus increasing the torque harmonics and noise of the motor.

### 5.14.3 Vibration inhibition

- It is used to suppress the large fluctuation of inverter output current, large fluctuation of motor speed and motor vibration.

Parameter	Name	Default	Setting Range	Content
13-02 P.285	Low frequency vibration inhibition factor	5	0 ~ 8	If the motor vibrates at a lower frequency, adjust the set value of 13-02 (P.285)
13-03 P.286	High frequency vibration inhibition factor	509	XX00~XX15	If the motor vibrates at a higher frequency, adjust the set value of 13-03 (P.286). It is recommended to gradually increase the set value based on the increment of 1 The setting range of the upper two bits and the lower two bits of 13-03 (P.286) is 0~15.
			00XX~15XX	

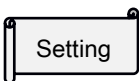
 Setting Vibration inhibition factor

- ◆ In practical application, whether the vibration is “low-frequency vibration” or “high-frequency vibration” is usually determined by the relationship between the occurring vibration frequency and the rated frequency of the motor, that is:

When the rated frequency of the motor is 50Hz,

If the occurring vibration frequency is lower than 25Hz, it will be deemed as “low-frequency vibration”.

Otherwise, if the occurring vibration frequency is higher than 25Hz, it will be deemed as “high-frequency vibration”.

Note: In case of light load condition, the current fluctuation in a specific operating frequency band may occur in the motor, which may cause slight vibration of the motor. If the vibration does not affect the application, it can be ignored.

### 5.14.4 Acceleration torque boost

- It is used to boost the acceleration torque and enhance the stability during acceleration process.

Parameter	Name	Default	Setting Range	Content
13-05 P.216	Acceleration torque boost	-60.0 ~ 60.0%	Acceleration torque boost	---

Note:

1. This function is only applicable in V/F mode (00-21(P.300)=0).
2. Generally, it is used when the acceleration time is short.

## 5.15 Tension control parameter group 14

Group	Parameter Number	Name	Setting Range	Default	Page
14-00	P.600	Tension control parameter	0 : Off	0	<a href="#">260</a>
			1 : Open loop torque control mode ( under closed loop vector control mode )		
			2 : Closed loop speed control mode		
			3 : Closed loop torque control mode ( under closed loop vector control mode )		
			4 : Constant linear speed control mode		
14-01	P.601	Rolling mode	0 : Wind roll	0	<a href="#">260</a>
			1 : Release roll		
14-02	P.602	Tightening roll option when releasing	0 : Forbid tightening material during startup	0	<a href="#">260</a>
			1 : Allow tightening material during startup		
14-03	P.603	Mechanical transmission ratio	0 ~ 300.00	1.00	<a href="#">260</a>
14-04	P.604	Tension setting source	0 : Parameter 14-05 ( P.605 ) setting	0	<a href="#">261</a>
			1 : Analog value or PULSE input setting		
			2 : Communication setting		
14-05	P.605	Tension setting	0 ~ 30000N	0N	<a href="#">261</a>
14-06	P.606	Maximum tension	0 ~ 30000N	0N	<a href="#">261</a>
14-07	P.607	Zero-speed tension increase	0 ~ 50.0%	0.0%	<a href="#">261</a>
14-08	P.608	Zero-speed threshold	0 ~ 30.00Hz	0.00Hz	<a href="#">261</a>
14-09	P.609	Tension taper	0 ~ 100.0%	0%	<a href="#">261</a>
14-10	P.654	Taper compension correction value	0 ~ 10000mm	0mm	<a href="#">261</a>
14-11	P.610	Winding radius calculation method options	0 : Calculate by linear speed	0	<a href="#">262</a>
			1 : Calculate by thickness(encoder of motor side) , pulse signal connects to A1/B1 of PG card		
			2 : Calculate by thickness (encoder of winding shaft) , pulse signal input to terminal M2		
			3 : Analog value of pulse input		
14-12	P.650	Calculate winding memory control by thickness calculation	0 : Do not save winding radius when power outage or calculation stops	0	<a href="#">262</a>
			1 : Save winding radius when there's a power outage or calculation stops , and use saved winding radius as initial winding radius when power recovers or calculation restarts		
14-13	P.611	Maximum winding radius	0 ~ 10000mm	500mm	<a href="#">262</a>
14-14	P.612	Winding diameter	0 ~ 10000mm	100mm	<a href="#">262</a>
14-15	P.613	Initial winding radius source	0 : Initial winding radius is determined by parameter 14-16(P.614) ~ 14-18(P.616)	0	<a href="#">262</a>
			1 : Initial winding radius is determined by analog value		
14-16	P.614	Initial winding radius 1	1 ~ 10000mm	100mm	<a href="#">263</a>
14-17	P.615	Initial winding radius 2	1 ~ 10000mm	100mm	<a href="#">263</a>
14-18	P.616	Initial winding radius 3	1 ~ 10000mm	100mm	<a href="#">263</a>
14-19	P.617	Winding radius filter time	0 ~ 1000ms	0ms	<a href="#">263</a>

Group	Parameter Number	Name	Setting Range	Default	Page
14-20	P.618	Current winding radius	0 ~ 10000mm	0mm	<a href="#">263</a>
14-21	P.619	Pulse per cycle	1 ~ 60000	1	<a href="#">263</a>
14-22	P.620	Cycle per layer	1 ~ 10000	1	<a href="#">263</a>
14-23	P.621	Material thickness setting source	0 : Material thickness is set by parameter 14-24 ( P.622 ) ~ 14-27 ( P.625 ) 1 : Material thickness is determined analog value	0	<a href="#">263</a>
14-24	P.622	Material thickness 0	0.01 ~ 100.00mm	0.01mm	<a href="#">263</a>
14-25	P.623	Material thickness 1	0.01 ~ 100.00mm	0.01mm	<a href="#">263</a>
14-26	P.624	Material thickness 2	0.01 ~ 100.00mm	0.01mm	<a href="#">263</a>
14-27	P.625	Material thickness 3	0.01 ~ 100.00mm	0.01mm	<a href="#">263</a>
14-28	P.626	Maximum thickness	0.01 ~ 100.00mm	1.00mm	<a href="#">263</a>
14-29	P.627	Linear speed input source	0 : Off 1 : Analog value or pulse input 2 : Communication setting	0	<a href="#">265</a>
14-30	P.628	Maximum linear speed	0.1 ~ 6500.0m/min	1000.0m/min	<a href="#">265</a>
14-31	P.629	Calculate R minimum linear speed	0.1 ~ 6500.0m/min	200.0m/min	<a href="#">265</a>
14-32	P.630	Actual linear speed	0 ~ 6500.0m/min	0.0m/min	<a href="#">265</a>
14-33	P.633	Mechanical inertia compensation coefficient	0 ~ 65535	0	<a href="#">266</a>
14-34	P.634	Material density	0 ~ 60000kg/ m <sup>3</sup>	0kg/ m <sup>3</sup>	<a href="#">266</a>
14-35	P.635	Material width	0 ~ 60000mm	0mm	<a href="#">266</a>
14-36	P.636	Friction compensation coefficient	0 ~ 50.0%	0.0%	<a href="#">267</a>
14-37	P.637	Material outage detection function	0 : Off 1 : Material outage detection function 1 2 : Material outage detection function 2 3: Material outage detection function 3	0	<a href="#">267</a>
14-38	P.638	Minimum speed detection	0.1 ~ 6500.0m/min	200.0m/min	<a href="#">267</a>
14-39	P.639	Error range detection	0.1 ~ 100.0%	10.0%	<a href="#">267</a>
14-40	P.640	Delay detection	0.1 ~ 60.0s	2.0s	<a href="#">267</a>
14-41	P.645	Pre-drive speed gain	-50.0% ~ 50.0%	0.0%	<a href="#">268</a>
14-42	P.646	Pre-drive torque increase	-50.0% ~ 50.0%	0.0%	<a href="#">268</a>
14-43	P.647	Pre-drive delay	0 ~ 65535ms	0ms	<a href="#">268</a>
14-44	P.656	Linear speed setting source	0 : Off 1 : Obtain linear speed via analog value or pulse input 2 : Obtain linear speed via communication	0	<a href="#">270</a>
14-45	P.657	Linear speed setting	0 ~ 6500.0m/min	0.0m/min	<a href="#">270</a>
14-46	P.658	Closed-loop tension limit standard	0 : Use rated frequency of motor as standard of limitation 1: Use system linear speed as standard of limitation	0	<a href="#">270</a>
14-47	P.659	Closed-loop tension limit deviation	0.0% ~ 100.0%	0.0%	<a href="#">270</a>

## 5.15.1 Tension control mode selection

## ➤ Tension control mode selection

Parameter	Name	Default	Setting Range	Content
14-00 P.600	Tention control mode selection	0	0	Off.
			1	Open-loop torque control mode ( Under closed-loop vector control )
			2	Closed-loop speed control mode
			3	Closed-loop torque control mode ( Under closed-loop vector control mode )
			4	Linear speed control mode
14-01 P.601	Winding mode	0	0	Wind up
			1	Release roll
14-02 P.602	Tightening roll option when releasing	0	0	Forbid tightening material during start-up
			1	Allow tightening material during start-up
14-03 P.603	Mechanical transfer ratio	1.00	0 ~ 300.00	Mechanical transfer ratio

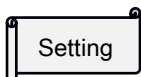
 Setting Tension control mode

- ◆ When 14-00(P.600) is 0 , tension control invalid , inverter is identical to general inverter.
- ◆ When 14-00(P.600) is 1 , opened-loop torque control mode is activated.The inverter keeps the tension consistent through controlling the output torque of the motor.Tension feedback is not required , but speed detection encoder must be installed when the inverter is working under closed-loop vector control mode.
- ◆ When 14-00(P.600) is 2 ,closed-loop speed mode is activated.The controlling result is to make the tension(position) feedback signal stable at the value given by PID.

Closed-loop means that tension (position) detection feedback is required to form a closed-loop adjustment.Speed control mode means that the inverter adjusts frequency according to feedback signal to achieve control.This program is operable in any motor control mode , i.e. 00-21 is able to be set to 0~4.

- ◆ When 14-00(P.600) is 3 ,closed-loop torque control mode is activated.Tension feedback closed-loop adjustment is added on the basis of opened-loop tension control.The tension signal fed back by the tension detection device and the tension setting value constitute the PID closed-loop adjustment which is used to adjust the inverter output torque reference.The control method of it works under closed-loop vector control.The speed encoder must be installed.
- ◆ When 14-00(P.600) is 4 , constant linear speed mode is activated.This is a special application in order to exclude the need of PID adjustment in operating constant linear control,which is more stable than the normal closed-loop control and applicable to some situations that require stable operation and doesn't require rapidly adjusting linear speed. This program is operable in any motor control mode , i.e. 00-21(P.300) is able to be set to 0~4.

- ◆ 14-01(P.601) is for selecting winding mode,which can be used together with wind/release terminal.When the switching terminal of the wind/release is invalid , the actual winding mode is the same as the function mode. When the switching terminal of the wind/release is valid,the actual setting of the winding mode is the same as the setting of the switching terminal of wind/release.
- ◆ 14-02(P.602) is for selecting if tightening material through motor inverse is allowed.If not allowed,inverter will output torque only when material is moving forward during releasing roll.
- ◆ 14-03(P.603) is the mechanical transmission ratio.Mechanical ratio=motor rotation speed/shaft rotation speed. Mechanical transmission ratio must be properly set during tension control mode.

## 5.15.2 Tension setting

➤ This part is only related to open-loop mode , set PID setting source via closed-loop mode.

Parameter	Name	Default	Setting Range	Content
14-04 P.604	Tension setting source	0	0	The parameter 14-05(P.605) setting.
			1	The analog value or PULSE input setting.
			2	Communication setting.
14-05 P.605	Tension setting	0N	0 ~ 30000N	---
14-06 P.606	Maximum tension	0N	0 ~ 30000N	---
14-07 P.607	Zero-speed tension increase	0.0%	0 ~ 50.0%	---
14-08 P.608	Zero-speed threshold	0.00Hz	0 ~ 30.00Hz	---
14-09 P.609	Tension taper	0.0%	0 ~ 100.0%	---
14-10 P.654	Taper compensation correction	0mm	0 ~ 10000mm	---

### Setting Tension setting

- ◆ The parameters in this part apply only to opened-loop torque mode .
- ◆ When 14-04(P.604) is 0, tension is set through 14-05(P.605).
- ◆ When 14-04(P.604) is 1, set tension via analog value or pulse input terminal. When setting tension by this method,maximum tension 14-06(P.606) must be set.The maximum general analog value setting and the maximum pulse setting both correspond to the maximum tension.The pulse can be set by the M2 terminal.
- ◆ When 14-04(P.604) is 2 , tension is set via communication.When controlling using upstream model,tension can be set by communication.There are two ways to set tension by communication,one is to alter the value of 14-05(P.605) (14-04(P.604) should be set to 0),the other is to set via modbus address H100C (14-04(P.604) should be set to 2).The setting range of modbus address H100C is 0~30000.

## Tension control parameter group 14

- ◆ 14-07(P.607) is the zero speed tension increase option, used to set the tension of the system during zero speed. It is mainly used to overcome the static friction at startup or keeping in a certain tension in zero speed. When controlling small tension or having startup difficulties, appropriately increase the value of this parameter.
- ◆ 14-08(P.608) is the zero speed threshold parameter. When inverter operation speed is lower than this parameter, it is considered working under zero speed.
- ◆ 14-09(P.609) is the tension taper parameter. This parameter is only used for winding control. When winding, there are times that would be necessary to reduce the tension when increasing the winding radius in order to ensure the material quality.

$$F=F0*\{1-K*[1-(D0+D1)/(D+D1)]\}$$

The formula of tension taper:

F: actual tension , F0 : set taper , D0:shaft diameter , D:actual winding diameter , D1:parameter 14-10(P.654)'s tension taper compensation value , K: tension taper.

- ◆ Parameter 14-10(P.654) is the tension taper compensation value, which is able to slow down the tension decrease.

### 5.15.3 Curling radius calculation

- The output torque is controlled by curling radius in open-loop torque mode. The output frequency corresponded to line speed is gained by curling radius in close-loop speed mode.

Parameter	Name	Default	Setting Range	Content
14-11 P.610	Winding radius calculation option	0	0	Calculate winding radius with linear speed
			1	Calculate by thickness(encoder of motor side) , pulse signal connects to A1/B1 of PG card
			2	Calculate by thickness (encoder of winding shaft) , pulse signal connects to M2 terminal
			3	Analog value or pulse input
14-12 P.650	Calculate winding memory control by thickness calculation	0	0	Not saving winding radius when power outage or calculation stops
			1	Save winding radius when there's a power outage or calculation stops , and use saved winding radius as initial winding radius when power recovers or calculation restarts
14-13 P.611	Maximum winding radius	500mm	1 ~ 10000mm	---
14-14 P.612	Mandrel radius	100mm	1 ~ 10000mm	---
14-15 P.613	Initial winding radius source	0	0	Initial winding radius is determined by parameter 14-16 ( P.614 ) ~ 14-18 ( P.616 )
			1	Initial winding radius is determined by analog value
14-16 P.614	Initial winding radius source1	100mm	1 ~ 10000mm	---
14-17 P.615	Initial winding radius source2	100mm	1 ~ 10000mm	---



Parameter	Name	Default	Setting Range	Content
14-18 P.616	Initial winding radius source3	100mm	1 ~ 10000mm	---
14-19 P.617	Winding radius filtering time	0ms	0 ~ 1000ms	---
14-20 P.618	Current winding value	0mm	0 ~ 10000mm	---
14-21 P.619	Pulse per cycle	1	1 ~ 60000	---
14-22 P.620	Cycle per layer	1	1 ~ 10000	---
14-23 P.621	Material thickness setting source	0	0	Material thickness is determined by parameter 14-24 ( P.622 ) ~ 14-27 ( P.625 )
			1	Material thickness is determined by analog value
14-24 P.622	Material thickness 0	0.01mm	0.01 ~ 100.00mm	---
14-25 P.623	Material thickness 1	0.01mm	0.01 ~ 100.00mm	---
14-26 P.624	Material thickness 2	0.01mm	0.01 ~ 100.00mm	---
14-27 P.625	Material thickness 3	0.01mm	0.01 ~ 100.00mm	---
14-28 P.626	Maximum thickness	1.00mm	0.01 ~ 100.00mm	---

Setting

Winding radius calculation

- ◆ The winding radius needs to be calculated in every tension control method. The winding radius can be obtained through the in winding radius calculation module integrated in the inverter or the external winding radius sensor.
- ◆ When parameter 14-11(P.610) is 0 , the winding radius is calculated by the system current linear speed and the inverter output frequency. The formula is as follows:  

$$D = (i \times V) / (\pi \times n)$$
Where D:winding radius , i:mechanical transmission ratio, V:linear speed , n:motor speed.  
When the system's operation speed is low, the linear speed of the material and the output frequency will be lower. The smaller the detection error the bigger the winding radius calculation error, so a minimum linear speed(14-31(P.629)) would be necessary. When the linear speed of the material is lower than parameter 14-31(P.629), the calculation stops, and the current radius is kept. The value should be set below the normal linear speed.
- ◆ When parameter 14-11(P.610) is 1, the winding radius is calculated by the encoder on the motor and the feedback of the gear. In this condition, connect the pulse signal to A1/B1 on the PG card, and set the encoder input type(09-02(P.351)) , mechanical transmission ratio(14-03(P.603)) , pulse per cycle(09-01(P.350)) , cycle per layer(14-22(P.620)), and material thickness(14-24(P.622)).
- ◆ When parameter 14-11(P.610) is 2 , the winding radius is calculated by the encoder on the winding shaft. In this condition, connect the pulse signal to the HDI terminal of the inverter and calculate the winding radius through the pulse per cycle(14-21(P.619)) , cycle per layer(14-22(P.620)), and the material thickness(14-24(P.622)).

## Tension control parameter group 14

- ◆ When parameter 14-11(P.610) is 3 , testing the winding radius with winding radius sensor,the input channel of the sensor can be either analog value or pulse input.
- ◆ Parameter 14-13(P.611) is used for setting the maximum winding radius.When parameter 14-11(P.610) is 3 , the maximum analog value or pulse signal must be set to correspond with the setting of parameter 14-13(P.611).
- ◆ Parameter 14-14(P.612) is used for setting winding shaft diameter.The winding radius calculated by the winding radius calculation module of the inverter is limited by 14-13(P.611) and 14-14(P.612).
- ◆ Parameter 14-15(P.613) is used for selecting the input terminal of the initial winding radius.
  1. When parameter 14-15(P.613) is 0 , the winding radius is set by parameter 14-16(P.614)~14-18(P.616).The initial value of the winding radius can be determined through two multi-function digital input terminals.The selection of the initial winding radius is as follows:

Digital input terminal 1	Digital input terminal 2	Initial curling radius source
0	0	14-14(P.612)
0	1	14-16(P.614)
1	0	14-17(P.615)
1	1	14-18(P.616)

2. When parameter 14-15(P.613) is 1 , the initial winding radius is determined by the analog value.When the initial winding radius is not calculated from the hollow winding radius,the initial winding radius can be selected by the digital input terminal.The default radius when winding is the diameter of the winding shaft(14-14(P.612)).The default radius when releasing is the maximum winding radius(14-13(P.611)).
- ◆ Parameter 14-19(P.617) is for setting the winding radius filtering coefficient.This parameter is used to avoid fast change of winding radius calculation (or input) result.
  - ◆ Parameter 14-20(P.618) is used for displaying the current winding radius.
  - ◆ Parameter 14-21(P.619)~14-28(P.626) is related to this parameter only when 14-11(P.610)=1 or 14-11(P.610)=2..
    1. Parameter 14-21(P.619) is the pulse per cycle.This setting is mandatory when 14-11(P.610)=2.
    2. Parameter 14-22(P.620) is cycle per wound layer , mostly used for wire.
    3. When parameter 14-23(P.621)=1 , material thickness equals to analog input,the maximum value of analog input corresponds to the value of 14-28(P.626).
    4. When 14-23(P.621) =0 , the default material thickness is determined by parameter 14-24(P.622).The different material thickness source can also be selected by the combination of digital input terminals and 14-24(P.622)~14-27(P.625).

The selections are as follows:

Digital input terminal 1	Digital input terminal 2	Initial thickness source
0	0	14-24(P.622)
0	1	14-25(P.623)
1	0	14-26(P.624)
1	1	14-27(P.625)

### 5.15.4 Linear speed input

- If the curling radius source selects line speed calculation or tension control mode as the close-loop speed control, it is required to obtain correct line speed signal.

Parameter	Name	Default	Setting Range	Content
14-29 P.627	Linear speed input source	0	0	No input
			1	Analog value or pulse input
			2	Communication setting
14-30 P.628	Maximum linear speed	1000.0 m/min	0.1 ~ 6500.0m/min	---
14-31 P.629	Minimum linear speed calculated by winding radius	200.0 m/min	0.1 ~ 6500.0m/min	---
14-32 P.630	Actual linear speed	0.0 m/min	0 ~ 6500.0m/min	---

#### Setting Line speed input

- ◆ For winding radius source, if linear speed calculation or tension control mode is selected as closed-loop speed control, accurate linear speed signal is required. The convenient way for obtaining linear speed is through analog output of operation frequency of traction (constant speed) inverter. The operation frequency of traction inverter corresponds to the linear speed linearly, needing only to set the maximum linear speed (14-30(P.628)) to the corresponding linear speed of the maximum frequency of the operation frequency of the traction inverter.
- ◆ 14-29(P.627) is used for selecting the method or channel for obtaining linear speed.
  1. When 14-29(P.627)=0, there is no linear speed input.
  2. When 14-29(P.627)=1, linear speed is obtained through analog value or pulse input. The correct maximum speed 14-30(P.628), analog value or pulse input's setting corresponding to maximum linear speed is required.
  3. When the linear speed (14-29(P.627)=2) is obtained through communication method, it is set by the modbus communication address H100A and the setting range is 0.1~6500.0m/min..
- ◆ 14-31(P.629) is for setting the minimum speed of winding radius when the calculation starts. When the inverter detects that the linear speed is lower than the value, winding radius calculation ceases. By correctly setting this value, deviation of winding radius calculation when speed is reducing can be effectively avoided. This value should be set over 20% of the maximum linear speed in general.
- ◆ 14-32(P.630) is for displaying the actual linear speed in real time.

## 5.15.5 Tension compensation

➤ Only relating to opened-loop torque mode.

Parameter	Name	Default	Setting Range	Content
14-33 P.633	Mechanical inertia compensation coefficient	0	0 ~ 65535	---
14-34 P.634	Material density	0kg/m <sup>3</sup>	0 ~ 60000kg/m <sup>3</sup>	---
14-35 P.635	Material width	0mm	0 ~ 60000mm	---
14-36 P.636	Friction compensation coefficient	0.0%	0 ~ 50.0%	---

### Setting Tension compensation

- ◆ When selecting opened-loop torque mode for tension control,during the acceleration/deceleration of the system,additional torque shall be provided in order to overcome the moment of inertia of the system.Otherwise,situation such as tension decrease when wind-up acceleration,tension increase when wind-up deceleration or tension increase when release acceleration,tension decrease when release decelerate might occur.
- ◆ 14-33(P.633) is for setting the mechanical inertia compensation coefficient.It is used to compensate the moment of inertia of the system, including motor, rotation system and shaft.Such inertias are fixed and are not related to the winding radius.This parameter can be obtained automatically by self learning or by manually setting according to the situation.
- ◆ 14-34(P.634) and 14-35(P.635) is related to material inertia compensation.The inverter will automatically calculate the material inertia compensation value according to the parameter and the winding radius.
- ◆ 14-36(P.636) is for setting the friction compensation coefficient.Take wind-up for instance, Material tension decreases because of friction, especially with small rolls.Also,it makes tension nonlinear.It can be improved by setting this parameter.

### 5.15.6 Material outage detection

➤ Supplementary function,not effective in all situations..

Parameter	Name	Default	Setting Range	Content
14-37 P.637	Material outage detection	0	0	No detection
			1	Material outage detection function 1
			2	Material outage detection function 2
			3	Material outage detection function 3
14-38 P.638	Minimum speed detection	200.0 m/min	0.1 ~ 6500.0m/min	Minimum linear speed detection when running out of material
14-39 P.639	Error range detection	10.0%	0.1 ~ 100.0%	Error range detection when running out of material
14-40 P.640	Delay determination	2.0s	0.1 ~ 60.0s	Delay determination when running out of material

Setting

Material outage detection

- ◆ The inverter automatically detects material outage through this parameter.This is a supplementary function,which doesn't apply to all situations.When not being able to get good results,set 14-37(P.637) to 0.
- ◆ Material outage detection function 1:During operation,when using linear speed to calculate winding angle ,and system linear speed is higher than 14-38(P.638),inverter will detect if there is a outage of material according to winding radius change,14-39(P.639) is used to set the error level of broken material detection.
- ◆ Material outage detection function 2: In the running state, when the tension closed-loop PID is enabled and the line speed is higher than 14-38 (P.638), the inverter detects the broken material according to the PID feedback status. P639 (P.639) is used to set the broken PID feedback level with detection.
- ◆ Material outage detection function 3: In the running state, the tension closed-loop PID is enabled, and the inverter detects whether the material is broken according to the position of the floating roller.
- ◆ When the system linear speed is higher than 14-38(P.638) , winding radius error (the current winding radius variation is too big compared to the previous winding radius) exceeds the range set in 14-39(P.639) , and the error time is over the delay time set in 14-40(P.640) , the inverter reports material outage failure(bEb)

## 5.15.7 Pre-drive control

- Changing roll during operation can prevent large impact.

Parameter	Name	Default	Setting Range	Content
14-41 P.645	Pre-drive speed gain	0.0%	-50.0% ~ 50.0%	---
14-42 P.646	Pre-drive torque increase	0.0%	-50.0% ~ 50.0%	Pre-drive torque gain percentage
14-43 P.647	Pre-drive delay	0ms	0 ~ 65535ms	Pre-drive torque increase delay

Setting

 Pre-drive control

- ◆ The schematic diagram of auto roll change is as follows ,there are two inverters which controls upper roll and lower roll change.

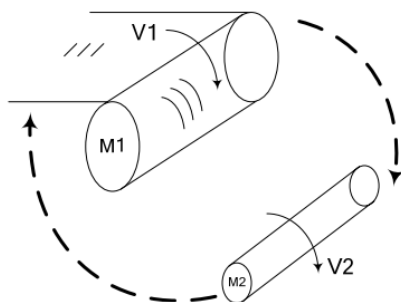

M1 is called "lower roll to be changed" , M2 is called "upper roll to be changed" or "pre-drive roll"

- ◆ To raise productivity,the winding shaft will generally be switched without turning off the machine.In order to achieve smooth roll changing and avoid large impact,rotating the winding shaft before hand would be necessary.The rotation linear speed and the material linear speed is the same.( $V1 \approx V2$ ).This function is called pre-drive.
- ◆ Auto roll change control logic

When continuous work,the auto roll change logic is used to achieve a smooth changing process in order to raise productivity.To achieve auto roll change,external controller is necessary.Motion B、 C、 D is only active when the lower roll inverter operates in closed-loop vector control mode(00-21(P.300)=4).

#### 1. Pre-drive process

When the upper roll inverter receives the pre-drive command,no matter how 14-00(P.600) is set,it will operate according to the matching frequency calculated by the given linear speed and the initial winding radius until the linear speed of the upper roll is consistent with the system linear speed.When the pre-drive signal disappears,the control mode will be switched to tension control mode.

#### 2. Torque memory signal

Before changing roll,the torque memory signal makes the lower roll inverter memorize the current torque for later process.

### 3. Torque memory enable

When the upper roll to be changed has contacted with the material and the lower roll hasn't been changed, no matter which torque control mode is selected, the lower roll inverter will be switched to torque control mode by the torque memory signal. The given torque command is the torque memorized by the previous inverter memory.

### 4. Torque increase function

When torque memory signal is enabled, the inverter will control the torque according to the memorized torque. Through setting the torque increase delay time, the output torque will increase according to the set torque increase proportion to keep a larger tension at the moment for easy cut off.

When roll change is finished, the pre-drive signal of the replaced upper roll's inverter will be revoked. The replaced roll's inverter operates in tension control mode. The process of roll change is ended after the lower roll inverter stops

- ◆ Pre-drive command, torque memory signal and torque memory enable signal mentioned above achieved by setting the corresponding function of digital input terminals.
- ◆ 14-41(P.645) is used to set the pre-drive speed gain. In order to meeting the technological requirements and fixing the linear speed error, the synchronous matching frequency can be adjusted. The formula is:

$$V2 = V1 * (1 + 14-41(P.645)).$$

When 14-41(P.645) < 0, the linear speed of the pre-drive roll will be lower than the material linear speed

- ◆ During the auto roll change process, when the torque memory enable signal is valid, the lower roll inverter will first control the torque according to the memorized torque. After the delay time set by 14-43(P.647), the output torque will be increased according to the torque increase proportion set by 14-42(P.646).

## 5.15.8 Constant linear speed mode

- Constant linear speed mode(14-00(P.600)=**"4"**) , used to select the method of acquiring the target constant linear speed.

Parameter	Name	Default	Setting Range	Content
14-44 P.656	Line speed setting source	0	0	Parameter 14-45 ( P.657 ) setting
			1	Obtain linear speed via analog value or pulse input
			2	Obtain linear speed via communication
14-45 P.657	Line speed setting	0.0 m/min	0 ~ 6500.0m/min	Linear speed setting value

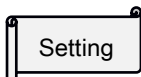
 Setting Linear speed setting source

- ◆ When 14-44(P.656)=0, linear speed is set by parameter 14-45(P.657).
- ◆ The linear speed is obtained by analog value or pulse input ( 14-44(P.656)=**1** )  
The maximum linear speed 14-30(P.628) must be set correctly.The maximum analog value and pulse input corresponds to the maximum linear speed.
- ◆ Obtain linear speed through communication ( 14-44(P.656)=**2** )  
Set address H100B through modbus.The setting range is 0~6500.0m/min

## 5.15.9 Tension closed-loop limiter

- Closed-loop speed control mode ( 14-00(P.600)=**2** ) , used to select the PID regulator output limit benchmark and limit bias.

Group	Parameter number	Default	Setting Range	content
14-46 P.658	Tension closed-loop limit standard	0	0	Motor frequency as limit standard
			1	Actual system linear speed as limit standard
14-47 P.659	Tension closed-loop limit bias	0.0%	0.0%~100.0%	Control limit bias by tension closed-loop

- ◆ Under closed-loop speed control mode, PID regulator limiter bias is set by 14-17(P.659). If this parameter is set to 0,when the system is at zero speed, the controller will not work. Appropriately setting bias can avoid this problem.



## 5.16 User parameter group 15

Group	Parameter Number	Name	Setting Range	Default	Page
15-00	P.900	User registered parameter 1	P parameter mode: 0~1299 Parameter group mode: 00-00~15-99	99999	<u>271</u>
15-01	P.901	User registered parameter 2		99999	<u>271</u>
15-02	P.902	User registered parameter 3		99999	<u>271</u>
15-03	P.903	User registered parameter 4		99999	<u>271</u>
15-04	P.904	User registered parameter 5		99999	<u>271</u>
15-05	P.905	User registered parameter 6		99999	<u>271</u>
15-06	P.906	User registered parameter 7		99999	<u>271</u>
15-07	P.907	User registered parameter 8		99999	<u>272</u>
15-08	P.908	User registered parameter 9		99999	<u>272</u>
15-09	P.909	User registered parameter 10		99999	<u>272</u>
15-10	P.910	User registered parameter 11		99999	<u>272</u>
15-11	P.911	User registered parameter 12		99999	<u>272</u>
15-12	P.912	User registered parameter 13		99999	<u>272</u>
15-13	P.913	User registered parameter 14		99999	<u>272</u>
15-14	P.914	User registered parameter 15		99999	<u>272</u>
15-15	P.915	User registered parameter 16		99999	<u>272</u>
15-16	P.916	User registered parameter 17		99999	<u>272</u>
15-17	P.917	User registered parameter 18		99999	<u>272</u>
15-18	P.918	User registered parameter 19		99999	<u>272</u>
15-19	P.919	User registered parameter 20		99999	<u>272</u>

### 5.16.1 User registered parameter

- The user parameter group is used to register the number of the parameter that does not require the user to restore the factory default value.

Parameter	Name	Default	Setting Range	Content
15-00 P.900	User registered parameter 1	99999	P mode: 0 ~ 1299 Parameter group mode: 00-00~15-99	---
15-01 P.901	User registered parameter 2	99999		---
15-02 P.902	User registered parameter 3	99999		---
15-03 P.903	User registered parameter 4	99999		---
15-04 P.904	User registered parameter 5	99999		---
15-05 P.905	User registered parameter 6	99999		---
15-06 P.906	User registered parameter 7	99999		---

## User parameter group15

Parameter	Name	Default	Setting Range	Content
15-07 P.907	User registered parameter 8	99999	P mode: 0 ~ 1299 Parameter group mode: 00-00~15-99	---
15-08 P.908	User registered parameter 9	99999		---
15-09 P.909	User registered parameter 10	99999		---
15-10 P.910	User registered parameter 11	99999		---
15-11 P.911	User registered parameter 12	99999		---
15-12 P.912	User registered parameter 13	99999		---
15-13 P.913	User registered parameter 14	99999		---
15-14 P.914	User registered parameter 15	99999		---
15-15 P.915	User registered parameter 16	99999		---
15-16 P.916	User registered parameter 17	99999		---
15-17 P.917	User registered parameter 18	99999		---
15-18 P.918	User registered parameter 19	99999		---
15-19 P.919	User registered parameter 20	99999		---

 Setting User registered parameter

- ◆ The parameter values set in this parameter group will not be restored to the factory default value when performing 00-02=5/6 ( P.999=2/3 ) .
- ◆ The parameter value set in this parameter group is the parameter number required to be registered by the user. The parameter values of the registered parameter number will not be restored to the factory default value when performing 00-02=5/6 ( P.999=2/3 ) .
- ◆ Please refer to 5.1.2 parameter management section for the setting of restoring the factory default value

Note: Please pay attention to the difference between parameter numbers registered in “order number” or “parameter group” mode.

For example, registering the parameter number 01-06(P.7). In the case of “order number”, the parameter number registered is P.7, and P.900=7 will be set; In the “parameter group” mode, the parameter number registered is 01-06 and 15-00=106 will be set.

## 6. INSPECTION AND MAINTENANCE

### 6.1 Inspection item

#### 6.1.1 Daily inspection item

- Inverter is mainly composed of semiconductor components. In order to prevent faults caused by influence of environment such as temperature, humidity, dust and vibration, or aging and service life of used parts, users must do daily inspections
  1. Whether the surrounding environment for installation is normal (temperature, humidity, dust density around inverter).
  2. Whether the power supply voltage is normal (whether the three-phase voltage between terminals R/L1, S/L2 and T/L3 is normal).
  3. Whether the wirings are firm (whether the external wirings of the main circuit terminal and the control board terminal are firm).
  4. Whether the cooling system is normal (whether there is abnormal sound at the fan operation and whether the connecting wire is firm).
  5. Whether the indicator light is normal (such as LED indicator on control board, LED indicator on keypad and LED on keypad screen).
  6. Whether the motor is running as expected.
  7. Whether there is abnormal vibration, sound or smell at the motor operation.
  8. Whether there is liquid leakage in the filter capacitor on the capacitor board.

 Caution Pay attention to safety during inspection!

#### 6.1.2 Periodical inspection items

Check the areas inaccessible during operation and requiring periodic inspection.

- Inspect places that can be inspected only when inverter stopped, inspect specific places on a regular basis.
  1. Inspect whether the connectors and connecting wires are normal (inspect whether the connectors and connecting wires between main circuit board and control board are firm or damaged).
  2. Inspect whether there is overheating components on main circuit board and control board.
  3. Inspect whether there is liquid leakage in the electrolytic capacitors on the main circuit board and control board.
  4. Inspect IGBT module on main circuit board.
  5. Make sure to clean the dust and sundries on the circuit board.
  6. Check the insulation resistance.
  7. Inspect the cooling system for abnormalities (whether fan connection line is firm or not, and make sure to clean the air filter/duct).
  8. Inspect whether frame is firm or not and tighten the fixing screw.
  9. Inspect whether the external wires and terminal are damaged or not.

 Caution Pay attention to safety during inspection!

### 6.1.3 Diodes and IGBT check

- Before checking, first remove the external wiring on main circuit terminals (R/L1、S/L2、T/L3、U/T1、V/T2、W/T3). Then set the meter to ohm-testing position.

	Positive probe	Negative probe	Normal result		Positive probe	Negative probe	Normal result
Terminal mark	R/L1	+P	Conductive	Terminal mark	U/T1	+P	Conductive
	S/L2	+P	Conductive		V/T2	+P	Conductive
	T/L3	+P	Conductive		W/T3	+P	Conductive
	+P	R/L1	Non-conductive		+P	U/T1	Non-conductive
	+P	S/L2	Non-conductive		+P	V/T2	Non-conductive
	+P	T/L3	Non-conductive		+P	W/T3	Non-conductive
	R/L1	-N	Non-conductive		U/T1	-N	Non-conductive
	S/L2	-N	Non-conductive		V/T2	-N	Non-conductive
	T/L3	-N	Non-conductive		W/T3	-N	Non-conductive
	-N	R/L1	Conductive		-N	U/T1	Conductive
	-N	S/L2	Conductive		-N	V/T2	Conductive
	-N	T/L3	Conductive		-N	W/T3	Conductive

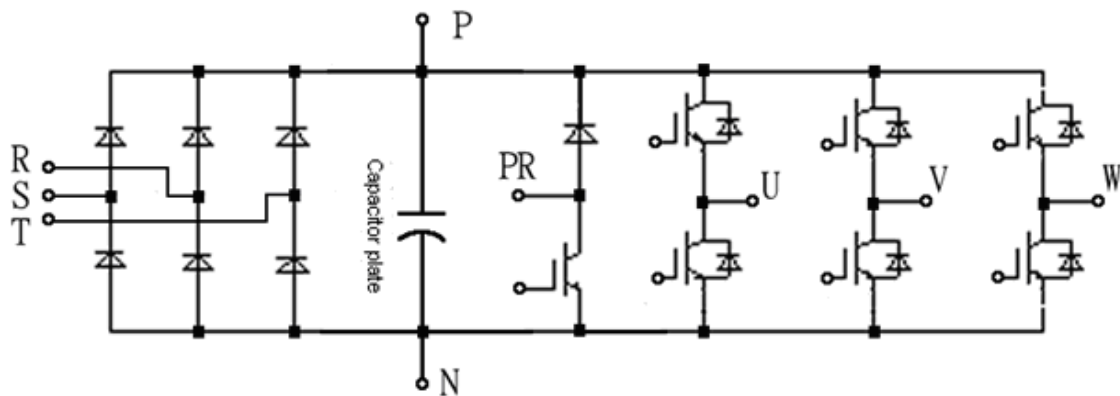

Note: The diagram above takes Frame C as an example.

### 6.1.4 Cleaning

- Always run the inverter in a clean status.
- ◆ Use a soft brush to remove dust and dirt on the fan blade, fan cover, and heat sink, keeping inverter in good heat dissipation.
- ◆ Gently wipe dirty areas on the cover with a soft cloth and neutral detergent..

Note: 1. Do not use solvent, such as acetone, benzene, toluene and alcohol to wipe the cover, these will cause inverter surface paint fall off .

2. Display on keypad (PU302) is vulnerable to detergent and alcohol. Therefore, avoid using them for cleaning.

### 6.1.5 Replacement parts

- Inverter is composed of many electronic components such as semiconductor components.
- Due to the composition or physical characteristics, the following components will age within a certain period of time, thus reducing the inverter performance and even causing faults. Therefore, it is necessary to replace them on a regular basis.
- Use lifetime detection function as a guidance of parts replacement.

Part name	Estimated lifespan	Description
Cooling fan	2 years	For the axle of a fan, the standard lifetime is about 10 – 35 thousand hours. If fan operates 24 hours per day, should be replaced every 2 years.
Capacitor	5 years	Capacitor is an electrolytic capacitor that deteriorates with time. The deterioration level depends on ambient conditions. Generally, it should be replaced every 5 years.
Relay	---	If bad contact occurs, please replace it immediately.

Note: 1. Please send the inverters to the factory for replacement.

2. For the replacement of cooling fan, please refer to section 3.10.

## 6.2 Ways to measure voltage, current, power on main circuit

### 6.2.1 Measurement instruments choosing

- Since inverter voltage and current on input side and output side includes harmonics, measurement data result may vary. Choose the instruments below (with commercial power supply) for measurement.

	Voltage(V)	Current(A)	Power(kW)
Input side(R/L1, S/L2, T/L3)	Moving-iron type	Moving-iron type	Electrodynamic type
DC side(+P, -N)	Moving-coil type	---	---
Output side(U/T1, V/T2, W/T3)	Rectifier type	Moving-iron type	Electrodynamic type

Note: 1. Please pay attention to the instrument range and polarity;  
2. Please pay attention to personal and property safety.

### 6.2.2 Measurement of voltages

- Inverter input side  
Input side voltage has a sine wave and with extremely small distortion, accurate measurement can be made with an ordinary AC meter.
- Inverter output side  
Since the output side voltage has a PWM-controlled rectangular wave, always use a rectifier type voltmeter. A pointer type meter cannot be used to measure the output side voltage as it indicates a value much greater than the actual value.  
A moving-iron type meter indicates an effective value which includes harmonics and therefore the value is larger than that of the fundamental wave.  
The value monitored on keypad is the inverter-controlled voltage itself. Hence, that value is accurate and it is recommended to monitor values (analog output) using keypad.

### 6.2.3 Measurement of currents

- Use moving-iron type meters on both the input and output sides of inverter. However, if the carrier frequency exceeds 5kHz, do not use this type of meter since an overcurrent losses produced in the internal metal parts of the meter will increase and may burn. In this case, use an approximate-effective value type.
- Since current on the inverter input side tends to be inbalanced, measure three phases together is recommended. Correct value cannot be obtained by measuring only one or two phases. On the other hand, the unbalanced ratio of each phase of the output side current should be within 10%.
- When a clamp ammeter is used, always use an effective value detection type. A mean value detection type produces a large error and may indicate an extremely smaller value than the actual value. The value monitored on keypad is accurate if the output frequency varies, and it is recommended to monitor values (provide analog output) using the keypad.

### 6.2.4 Measurement of power

- Use digital power meters at the input and output terminals of inverter simultaneously, or use electrodynamic meters at the input and output terminals of inverter simultaneously. Then, measure the power by the 2-power measurement method or the 3-power measurement method. However, the input terminal current tends to be inbalanced, so it is recommended to use 3-power measurement method for measurement.

### 6.2.5 Measurement of frequency

- Default setting of HDO terminal is FM function, a pulse train proportional to the output frequency is output across terminal HDO and SD. This pulse train output can be counted by a frequency counter, or a meter (moving-coil type voltmeter) can be used to read the average value of the pulse train output voltage.
- Please refer to Section 5.3.9.

### 6.2.6 Measurement of insulation resistance

- Inverter insulation resistance
  1. Before measuring the inverter insulation resistance, first dismount the wiring of all the main-circuit terminals and control board. Then do the wiring as shown in the right picture.
  2. The measurement is only suitable for the main circuit. It is prohibited to use a high-resistance meter for measuring terminals on the control board.
  3. The value of the insulation resistance shall be greater than 5MΩ.

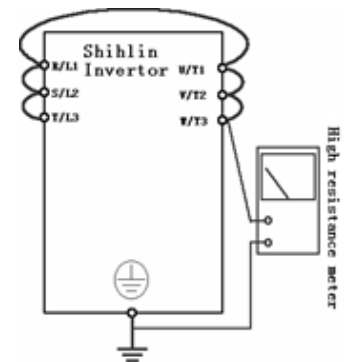

Note: Please use a 500 VDC megger.

- Motor insulation resistance
  1. Before the measurement, please dismount the motor, and execute the wiring as shown in the diagram on the right.
  2. The value of the insulation resistance shall be greater than 5MΩ.

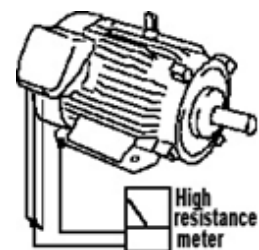

Note: Please use a suitable megger.

### 6.2.7 Hi-pot test

- Do not conduct a hi-pot test. Deterioration may occur on the internal semiconductor components of the inverter.

## 7. APPENDIX

## 7.1 Appendix 1 Parameter table

## 7.1.1 P parameter mode

Parameter Number	Group	Name	Setting Range	Default	Page
P.0	01-10	Torque boost	0.75K: 0 ~ 30.0%	6.0%	<u>83</u>
			1.5K ~ 3.7K: 0 ~ 30.0%	4.0%	
			5.5K ~ 7.5K: 0 ~ 30.0%	3.0%	
			11K ~ 22K: 0 ~ 30.0%	2.0%	
P.1	01-00	Maximum frequency	22K and below: 0.00 ~ 01-02(P.18)Hz	120.00HZ	<u>80</u>
P.2	01-01	Minimum frequency	0 ~ 120.00Hz	0.00Hz	<u>80</u>
P.3	01-03	Base frequency	50Hz system setting: 0 ~ 650.00Hz	50.00Hz	<u>80</u>
			60Hz system setting: 0 ~ 650.00Hz	60.00Hz	
P.4	04-00	Speed1(high speed)	0 ~ 650.00Hz	60.00Hz	<u>135</u>
P.5	04-01	Speed2(medium speed)	0 ~ 650.00Hz	30.00Hz	<u>135</u>
P.6	04-02	Speed3(low speed)	0 ~ 650.00Hz	10.00Hz	<u>135</u>
P.7	01-06	Acceleration time	3.7K and below: 0~360.00s/0~3600.0s	5.00s	<u>81</u>
			5.5K and above:0~360.00s/0~3600.0s	20.00s	
P.8	01-07	Deceleration time	3.7K and below:0~360.00s/0~3600.0s	5.00s	<u>81</u>
			5.5K~7.5K:0~360.00s/0~3600.0s	10.00s	
			11K and above: 0~360.00s/0~3600.0s	30.00s	
P.9	06-00	Electronic thermal relay capacity	0~500.00A	0.00A	<u>153</u>
P.10	10-00	DC brake operating frequency	0 ~ 120.00Hz	3.00Hz	<u>215</u>
P.11	10-01	DC brake operating time	0 ~ 60.0s	0.5s	<u>215</u>
P.12	10-02	DC brake operating voltage	0 ~ 30.0%: 7.5K and below	4.0%	<u>215</u>
			0 ~ 30.0%: 11K ~ 22K	2.0%	
P.13	01-11	Starting frequency	0 ~ 60.00Hz	0.50Hz	<u>84</u>
P.14	01-12	Load pattern selection	0: For constant torque loads (conveyor belt, etc.)	0	<u>84</u>
			1: For variable torque loads (fans and pumps, etc.)		
			2~3: For Lifting loads		
			4: Multipoint V/F curve		
			5~13: Special two-point V/F curve		
			14: V/F complete detached mode		
			15: V/F semidetached mode		
P.15	01-13	JOG frequency	0 ~ 650.00Hz	5.00Hz	<u>87</u>
P.16	01-14	JOG acceleration/ deceleration time	0 ~ 360.00s/0 ~ 3600.0s	0.50s	<u>87</u>
P.17	02-20	Terminal 4-5 signal range selection	0: Signal sampling range from 4~20mA.	0	<u>107</u>
			1: Signal sampling range from 0 ~ 10V.		
			2: Signal sampling range from 0 ~ 5V.		



Parameter Number	Group	Name	Setting Range	Default	Page
P.18	01-02	High-speed maximum frequency	01-00(P.1) ~ 650.00Hz	120.00Hz	<u>80</u>
P.19	01-04	Base voltage	0 ~ 1000.0V	99999	<u>80</u>
			99999: Change according to the input voltage		
P.20	01-09	Acceleration/deceleration reference frequency	50Hz system setting: 1.00 ~ 650.00Hz	50.00Hz	<u>81</u>
			60Hz system setting: 1.00 ~ 650.00Hz	60.00Hz	
P.21	01-08	Acceleration/deceleration time increments	0: Time increment is 0.01s	0	<u>81</u>
			1: Time increment is 0.1s		
P.22	06-01	Stall prevention operation level	0 ~ 250.0%	150.0%	<u>154</u>
P.23	06-02	Stall prevention operation level correction factor	0 ~ 150.0%	99999	<u>154</u>
			99999: Stall prevention operation level is the setting value of 06-01(P.22).		
P.24	04-03	Speed 4	0 ~ 650.00Hz	99999	<u>135</u>
			99999: Off		
P.25	04-04	Speed 5	Same as 04-03(P.24)	99999	<u>135</u>
P.26	04-05	Speed 6	Same as 04-03(P.24)	99999	<u>135</u>
P.27	04-06	Speed 7	Same as 04-03(P.24)	99999	<u>135</u>
P.28	01-15	Output frequency filter time	0 ~ 1000ms	0ms	<u>87</u>
P.29	01-05	Acceleration/deceleration curve selection	0: Linear acceleration /deceleration curve	0	<u>81</u>
			1: S shape acceleration /deceleration curve 1		
			2: S shape acceleration /deceleration curve 2		
			3: S shape acceleration /deceleration curve 3		
P.30	06-05	Regenerative brake function selection	0: Brake duty is fixed at 3%, parameter 06-06 (P.70) will be off.	0	<u>156</u>
			1: Brake duty is 06-06(P.70) value.		
P.31	00-12	Soft-PWM carrier operation selection	0: Off	0	<u>70</u>
			1: When 00-11(P.72)< 5, Soft-PWM is on (only apply to V/F control )		
P.32	07-02	COM1 Serial communication baud rate	0: Baud rate: 4800bps	1	<u>171</u>
			1: Baud rate: 9600bps		
			2: Baud rate: 19200bps		
			3: Baud rate: 38400bps		
			4: Baud rate: 57600bps		
5: Baud rate: 115200bps					
P.33	07-00	COM1 Communication protocol selection	0: Modbus protocol	1	<u>171</u>
			1: Shihlin protocol		
			2 : PLC protocol ( Effective when using Shilin built-in PLC )		
P.34	07-11	Communication EEPROM write-in selection	0: When writing parameters in communication mode, write in RAM and EEPROM	0	<u>187</u>
			1: When writing parameters through communication, only write into RAM		

Appendix 1 Parameter table

Parameter Number	Group	Name	Setting Range	Default	Page
P.35	00-19	Communication mode selection	0: In communication mode, run signal and frequency is given by communication.	0	<u>73</u>
			1: In communication mode, run signal and frequency is given by external signal.		
P.36	07-01	COM1 inverter communication station number	0 ~ 254	0	<u>171</u>
P.37	00-08	Speed display	0: Display output frequency(not mechanical speed)	0	<u>70</u>
			1~5000.0		
			1~9999		
P.38	02-09	Terminal 2-5 maximum running frequency	50Hz system: 1.00 ~ 650.00Hz	50.00Hz	<u>102</u>
			60Hz system: 1.00 ~ 650.00Hz	60.00Hz	
P.39	02-21	Terminal 4-5 maximum operation frequency	50Hz system: 1.00 ~ 650.00Hz	50.00Hz	<u>107</u>
			60Hz system: 1.00 ~ 650.00Hz	60.00Hz	
P.40	03-10	Terminal SO1-SE output function	0: RUN(Output when inverter running)	1	<u>126</u>
			1: SU(Output when reach target frequency)		
			2: FU(Output when reach 03-21 03-22 value )		
			3: OL(Output when overload)		
			4: OMD(Output when output current is zero)		
			5: ALARM(Output when alarm)		
			6: PO1(Output when in program operation step)		
			7: PO2(Output when in program operation cycle)		
			8: PO3(Output when in program operation pause)		
			9: BP(Output when use inverter output in function : switch between inverter and commercial power-supply)		
			10: GP(Output when use commercial power supply in function : switch between inverter and commercial power-supply)		
			11 : OMD1(Output when output current is zero 1)		
			12 ~ 16: Reserved		
			17: RY(Output when inverter is powered on and no alarm)		
			18: Output when it's time for maintenance		
			19: OL2 (Output when overload 2)		
20: Output when capacitor abnormal					
21: Output when in position control reach position					
22 : Output when detect curl in tension control					
23 : Output when detect power marker					
24 ~ 40: Reserved					
41 : Feedback disconnection alarm					
P.41	03-20	Output frequency detection sensitivity	0 ~ 100.0%	10.0%	<u>129</u>
P.42	03-21	Output frequency detection for forward rotation	0 ~ 650.00Hz	6.00Hz	<u>129</u>

Parameter Number	Group	Name	Setting Range	Default	Page
P.43	03-22	Output frequency detection for reverse rotation	0 ~ 650.00Hz	99999	<u>129</u>
			99999: Same as the setting of 03-21(P.42)		
P.44	01-22	Second acceleration time	0 ~ 360.00s/0 ~ 3600.0s	99999	<u>89</u>
			99999: Off		
P.45	01-23	Second deceleration time	0 ~ 360.00s/0 ~ 3600.0s	99999	<u>89</u>
			99999: Off		
P.46	01-24	Second torque boost	0 ~ 30.0%	99999	<u>89</u>
			99999: Off		
P.47	01-25	Second base frequency	0 ~ 650.00Hz	99999	<u>89</u>
			99999: Off		
P.48	07-03	COM1 Data length	0: 8bit	0	<u>171</u>
			1: 7bit		
P.49	07-04	COM1 Stop bit length	0: 1bit	0	<u>171</u>
			1: 2bit		
P.50	07-05	COM1 parity check selection	0: No parity check	0	<u>171</u>
			1: Odd		
			2: Even		
P.51	07-06	COM1 CR/LF selection	1: CR only	1	<u>171</u>
			2: Both CR and LF		
P.52	07-08	COM1 Number of communication retries	0 ~ 10	1	<u>171</u>
P.53	07-09	COM1 communication interval allowed time	0~999.8s: Checking communication timeout with the set value	99999	<u>171</u>
			99999: No timeout check		
P.54	02-04	Terminal AM output function	0: Output frequency, use 02-51 (P.55) value as 100%.	0	<u>99</u>
			1: Output current, use 02-52 (P.56) value as 100%.		
			2: Output DC bus voltage, use the OV trigger voltage as 100%.		
			3: Output inverter temperature accumulate rising rate, use NTC trigger level as 100%.		
			4: Output inverter thermal relay accumulate rate, use the digital thermal relay trigger level ( 06-00 ( P.9 ) ≠ 0 ) or the thermal relay on IGBT trigger level ( 06-00 (P.9) = 0 ) as 100%.		
			5: Target frequency, use 02-51(P.55) value as 100%.		
			6: Fixed output, voltage or current output level can be set by 02-54 (P.541)		
			7: Output voltage, use inverter rated voltage as 100%		
8: Excitation current, use motor rated current as 100%. (Valid only when 00-21(P.300) or 00-22 (P.370) is set to 3~6)					

Appendix 1 Parameter table

Parameter Number	Group	Name	Setting Range	Default	Page
P.54	02-04	Terminal AM output function	9: Output torque, use two times motor rated torque as 100%.(Valid only when 00-21 (P.300) or 00-22 (P.370) is set to 3~6)	0	<u>99</u>
			10: Output power, use two times motor rated power as 100%.		
			11: High-speed pulse input, use 100KHz as 100%.		
			12: Motor speed, use 02-51 (P.55) as 100%		
			13 : PLC analog output, for details please refer to SE3 built-in PLC manual		
P.55	02-51	Maximum analog output frequency reference	50Hz system: 1.00 ~ 650.00Hz	50.00Hz	<u>113</u>
			60Hz system: 1.00 ~ 650.00Hz	60.00Hz	
P.56	02-52	Maximum analog output current reference	0~500.00A	According to type	<u>113</u>
P.57	10-09	Restart idling time	0 ~ 30.0s	99999	<u>218</u>
			99999: Off.		
P.58	10-10	Restart rising time	0 ~ 60.0s: 7.5K (included) and below.	5.0s	<u>218</u>
			0 ~ 60.0s: 11K ~ 22K	10.0s	
P.60	02-10	Terminal 2-5 filter time	0 ~ 2000ms	30ms	<u>102</u>
P.61	10-11	Remote control function	0: Off	0	<u>220</u>
			X1: Remote control function, frequency save in memory		
			X2: Remote control function, frequency won't save		
			X3: Remote control function, frequency won't save, clear frequency setting every time STF/STR "turn off".		
			X4: Remote control function, frequency save, the interval between two frequency memory time is not less than 5s		
1X: Target frequency range 01-01(P.2)~01-00(P.1). The target frequency comes from the setting during RH, RM operation.					
P.62	03-23	Zero current detection level	0 ~ 200.0%	5.0%	<u>130</u>
			99999: Off		
P.63	03-24	Zero current detection time	0 ~ 100.00s	0.50s	<u>130</u>
			99999: Off		
P.64	02-45	Terminal AM output signal selection	0: Output 0~10V across terminal AM-5.	0	<u>111</u>
			1: Reserved		
			2: Output 0~20mA across AM-5.		
			3: Output 4~20mA across AM-5.		
P.65	10-12	Auto reset function	0: Off.	0	<u>222</u>
			1: When over-voltage, inverter will reset.		
			2: When over-current, inverter will reset.		
			3: When either over-voltage or over-current, inverter will reset.		
			4: When any alarm occur, inverter will reset.		
P.66	06-03	Stall prevention operation reduction starting frequency	50Hz system: 0 ~ 650.00Hz	50.00Hz	<u>154</u>
			60Hz system: 0 ~ 650.00Hz	60.00Hz	

Parameter Number	Group	Name	Setting Range	Default	Page
P.67	10-13	Auto reset times	0: Off.	0	<a href="#">222</a>
			1 ~ 10: If the alarm exceeds 10-13(P.67) times, inverter will not reset.		
P.68	10-14	Auto reset waiting time	0 ~ 360.0s	1.0s	<a href="#">222</a>
P.69	10-15	Auto reset times count	Read	0	<a href="#">222</a>
P.70	06-06	Special regenerative brake duty	0 ~ 100.0%	0.0%	<a href="#">156</a>
P.71	00-13	Idling brake / DC brake	0: Idling brake	1	<a href="#">71</a>
			1: DC brake		
P.72	00-11	Carrier frequency	1~15 kHz	5 kHz	<a href="#">70</a>
P.73	02-08	Terminal 2-5 signal range selection	0: Signal sampling range from 0 ~5V.	1	<a href="#">101</a>
			1: Signal sampling range from 0 ~10V.		
			2: Signal sampling range from 0 ~ -5V.		
			3: Signal sampling range from 0 ~ -10V.		
			4: Signal sampling range from -5 ~ +5V.		
			5: Signal sampling range from -10 ~ +10V.		
P.74	02-43	Terminal HDO clock multiplier factor	0: Select FM function as the output function of terminal HDO.	0	<a href="#">110</a>
			1 ~ 9000: factor for square-wave pulse output frequency.Value in 02-43 (P.74) times output frequency will be actual output pulse frequency.		
P.75	00-14	Stop function selection	0: Press STOP button and inverter stop running in PU and H2 mode	1	<a href="#">71</a>
			1: Press STOP button and inverter stop running in all mode.		
P.77	00-03	Selection of parameters write protection	0: Parameters can be written only when the motor stops.	0	<a href="#">65</a>
			1: Parameters cannot be written.		
			2: Parameters can also be written when the motor is running.		
			3: Parameters cannot be read when in password protection.		
P.78	00-15	Prevent forward/reverse rotation selection	0: Forward/reverse rotation are both permitted.	0	<a href="#">72</a>
			1: Prevent reverse rotation (Giving reverse signal decelerates and stops the motor).		
			2: Prevent forward rotation (Giving forward signal decelerates and stops the motor).		
P.79	00-16	Operation mode selection	0: "PU mode", "external mode" and "Jog mode" are interchangeable.	0	<a href="#">72</a>
			1: "PU mode" and "JOG mode" are interchangeable.		
			2: "External mode" only		
			3: "Communication mode" only		
			4: "Combined mode 1"		
			5: "Combined mode 2"		
			6: "Combined mode 3"		
			7: "Combined mode 4"		
			8: "Combined mode 5"		

Appendix 1 Parameter table

Parameter Number	Group	Name	Setting Range	Default	Page
P.79	00-16	Operation mode selection	99999: Second operation mode, run command is set by 00-18(P.109), target frequency is set by 00-17(P.97)	0	<u>72</u>
P.80	03-03	Terminal M0 input function	Same as 03-00	2	<u>121</u>
P.81	03-04	Terminal M1 input function	Same as 03-00	3	<u>121</u>
P.82	03-05	Terminal M2 input function	Same as 03-00	4	<u>121</u>
P.83	03-00	Terminal STF input function	0: STF(Inverter runs forward)	0	<u>119</u>
			1: STR(Inverter runs reverse)		
			2: RL(Multi-speed low speed)		
			3: RM(Multi-speed medium speed)		
			4: RH(Multi-speed high speed)		
			5:AU( Analog terminal 4-5 high priority)		
			6: External thermal relay actuate		
			7: MRS(Stops inverter output immediately)		
			8: RT(Inverter second function)		
			9: EXT(External JOG)		
			10: STF+EXJ		
			11: STR+EXJ		
			12: STF+RT		
			13: STR+RT		
			14: STF+RL		
			15: STR+RL		
			16: STF+RM		
			17: STR+RM		
			18: STF+RH		
			19: STR+RH		
			20: STF+RL+RM		
			21: STR+RL+RM		
			22: STF+RT+RL		
			23: STR+RT+RL		
			24: STF+RT+RM		
			25: STR+RT+RM		
			26: STF+RT+RL+RM		
			27: STR+RT+RL+RM		
			28: RUN(Inverter runs forward)		
			29: STF/STR(use with RUN signal, when ON, motor runs reverse ; when OFF, motor runs forward)		
			30: RES(External reset function)		
			31: STOP(Use as three line control with RUN signal and STF-STR signal)		
			32: REX(Extend multi-speed to 16 levels)		

Parameter Number	Group	Name	Setting Range	Default	Page
P.83	03-00	Terminal STF input function	33: PO(In "external mode", run programmed operation)	0	<u>119</u>
			34: RES_E (External reset, valid only when alarm.)		
			35: MPO (In "external mode" run manual cycle operation.)		
			36: TRI(Triangle wave function)		
			37: GP_BP (Automatic switch between inverter and commercial power-supply.)		
			38: CS(Manual switch to commercial power supply)		
			39: STF/STR +STOP (Use with RUN signal, when ON, motor runs reverse,when OFF, motor stops then runs forward.)		
			40: P_MRS (Stops inverter output immediately by pulse signal input)		
			41: PWM set frequency(Note 1)		
			42: MTCLKA/MTCLKB(only for M0/M1)		
			43: RUN_EN (Enable digital input terminal operation)		
			44: PID_OFF (Enable digital input terminal turning off PID)		
			45: Second mode		
			46: Initial roll radius selection 1		
			47: Initial roll radius selection 2		
			48: Thickness selection 1		
			49: Thickness selection 2		
			50: Winding unwinding switch		
			51: Predrive command		
			52: Save torque value		
			53: Save torque value enable		
			54: Revs counting signal (note1)		
			55: Speed/Torque control switch		
			56: Roll radius reset		
			57: High-speed pulse input function (note1)		
			58: Analog terminal 2-5 high priority		
			59: Reserved		
			60: Built-in PLC start/stop		
			61: SHOM (Homing enable)		
			62: ORGP (Set homing point)		
			63: Position/Speed control switch		
			64: External zero-servo switch		
			65: External accelerate/decelerate pause		
66: External forced stop					
67 : Roll diameter calculation stop					
68 : Enable single point positioning					
69 : Enable multipoint positioning					
70 : Enable entire position control by pulse input command					
71 : External torque command polarity reverse					
99999 : Off					
P.84	03-01	Terminal STR input function	Same as 03-00(P.83)	1	<u>120</u>
P.85	03-11	Terminal A-B-C output function	Same as 03-10(P.40)	5	<u>126</u>

Appendix 1 Parameter table

Parameter Number	Group	Name	Setting Range	Default	Page
P.86	03-02	Terminal RES input function	Same as 03-00(P.83)	30	<u>120</u>
P.87	03-14	Digital input logic	0 ~ 1023	0	<u>127</u>
P.88	03-15	Digital output logic (with expansion card)	0 ~ 4095	0	<u>127</u>
P.89	13-00	Slip compensation coefficient	0 ~ 10	0	<u>256</u>
P.90	00-00	Inverter model	Read only	Read	<u>62</u>
P.91	01-16	Frequency jump 1A	0 ~ 650.00Hz	99999	<u>88</u>
			99999: Off		
P.92	01-17	Frequency jump 1B	0 ~ 650.00Hz	99999	<u>88</u>
			99999: Off		
P.93	01-18	Frequency jump 2A	0 ~ 650.00Hz	99999	<u>88</u>
			99999: invalid		
P.94	01-19	Frequency jump 2B	0 ~ 650.00Hz	99999	<u>88</u>
			99999: Off		
P.95	01-20	Frequency jump 3A	0 ~ 650.00Hz	99999	<u>88</u>
			99999: Off		
P.96	01-21	Frequency jump 3B	0 ~ 650.00Hz	99999	<u>88</u>
			99999: Off		
P.97	00-17	Second target frequency selection	0: Frequency set by keypad	0	<u>73</u>
			1: Frequency set by RS485 communication		
			2: Frequency set by analog input		
			3: Frequency set by communication expansion card		
			4: Frequency set by PG card A2 B2		
5: Frequency set by HDI pulse					
P.98	01-26	Middle frequency 1	0 ~ 650.00Hz	3.00Hz	<u>90</u>
P.99	01-27	Output voltage 1 of middle frequency	0 ~ 100.0%	10.0%	<u>90</u>
P.100	04-15	Programmed operation minute / second selection	0: Select minute as the time increment.	1	<u>137</u>
			1: Select second as the time increment.		
P.101	04-27	Programmed operation mode speed 1 operating time	0 ~ 6000.0s	0.0s	<u>137</u>
P.102	04-28	Programmed operation mode speed 2 operating time	0 ~ 6000.0s	0.0s	<u>137</u>
P.103	04-29	Programmed operation mode speed 3 operating time	0 ~ 6000.0s	0.0s	<u>137</u>
P.104	04-30	Programmed operation mode speed 4 operating time	0 ~ 6000.0s	0.0s	<u>137</u>



Parameter Number	Group	Name	Setting Range	Default	Page
P.105	04-31	Programmed operation mode speed 5 operating time	0 ~ 6000.0s	0.0s	<a href="#">137</a>
P.106	04-32	Programmed operation mode speed 6 operating time	0 ~ 6000.0s	0.0s	<a href="#">137</a>
P.107	04-33	Programmed operation mode speed 7 operating time	0 ~ 6000.0s	0.0s	<a href="#">137</a>
P.108	04-34	Programmed operation mode speed 8 operating time	0 ~ 6000.0s	0.0s	<a href="#">137</a>
P.109	00-18	Second start signal selection	0: Start signal set by keypad 1: Start signal set by digital input terminal 2: Start signal set by RS485 communication 3: Start signal set by communication expansion card	0	<a href="#">73</a>
P.110	00-06	Parameter unit monitoring selection	X0: When inverter starts, keypad enters monitor mode automatically, screen displays output frequency. X1: When inverter starts, screen displays steady state frequency. X2: When inverter starts, keypad enters monitor mode automatically, screen displays current pressure and feedback pressure of the constant pressure system in percentage X5: When inverter starts, keypad enters monitor mode automatically, screen displays current pressure and feedback pressure of the constant pressure system 0X : Boot screen monitors output frequency 1X : Boot screen is in target frequency setting mode 2X : Boot screen monitors output current 3X : Boot screen monitors output voltage	1	<a href="#">69</a>
P.111	04-35	Programmed operation mode speed 1 Acc/Dec time	0 ~ 600.00s/0 ~ 6000.0s	0.00s	<a href="#">137</a>
P.112	04-36	Programmed operation mode speed 2 Acc/Dec time	0 ~ 600.00s/0 ~ 6000.0s	0.00s	<a href="#">137</a>
P.113	04-37	Programmed operation mode speed 3 Acc/Dec time	0 ~ 600.00s/0 ~ 6000.0s	0.00s	<a href="#">138</a>
P.114	04-38	Programmed operation mode speed 4 Acc/Dec time	0 ~ 600.00s/0 ~ 6000.0s	0.00s	<a href="#">138</a>
P.115	04-39	Programmed operation mode speed 5 Acc/Dec time	0 ~ 600.00s/0 ~ 6000.0s	0.00s	<a href="#">138</a>
P.116	04-40	Programmed operation mode speed 6 Acc/Dec time	0 ~ 600.00s/0 ~ 6000.0s	0.00s	<a href="#">138</a>
P.117	04-41	Programmed operation mode speed 7 Acc/Dec time	0 ~ 600.00s/0 ~ 6000.0s	0.00s	<a href="#">138</a>

Appendix 1 Parameter table

Parameter Number	Group	Name	Setting Range	Default	Page
P.118	04-42	Programmed operation mode speed 8 Acc/Dec time	0 ~ 600.00s/0 ~ 6000.0s	0.00s	<a href="#">138</a>
P.119	10-16	Forward and reverse rotation dead time	0 ~ 3000.0s	0.0s	<a href="#">223</a>
P.120	03-16	Output signal delay time	0 ~ 3600.0s	0.0s	<a href="#">128</a>
P.121	04-16	Run direction in each section	0 ~ 255	0	<a href="#">137</a>
P.122	04-17	Programmed operation cycle selection	0:Off	0	<a href="#">137</a>
			1 ~ 8: Start cycle from the set section.		
P.123	04-18	Programmed operation acceleration / deceleration time setting selection	0: Acceleration time is 01-06(P.7), deceleration time is 01-07(P.8).	0	<a href="#">137</a>
			1: Acceleration and deceleration time is set by 04-35(P.111) ~ 04-42(P.118).		
P.124	09-13	Expansion card version	Read only	Read	<a href="#">209</a>
P.125	00-26	Expansion card type	Read only	Read	<a href="#">76</a>
P.131	04-19	Programmed operation mode speed 1	0 ~ 650.00Hz	0.00Hz	<a href="#">137</a>
P.132	04-20	Programmed operation mode speed 2	0 ~ 650.00Hz	0.00Hz	<a href="#">137</a>
P.133	04-21	Programmed operation mode speed 3	0 ~ 650.00Hz	0.00Hz	<a href="#">137</a>
P.134	04-22	Programmed operation mode speed 4	0 ~ 650.00Hz	0.00Hz	<a href="#">137</a>
P.135	04-23	Programmed operation mode speed 5	0 ~ 650.00Hz	0.00Hz	<a href="#">137</a>
P.136	04-24	Programmed operation mode speed 6	0 ~ 650.00Hz	0.00Hz	<a href="#">137</a>
P.137	04-25	Programmed operation mode speed 7	0 ~ 650.00Hz	0.00Hz	<a href="#">137</a>
P.138	04-26	Programmed operation mode speed 8	0 ~ 650.00Hz	0.00Hz	<a href="#">137</a>
P.139	02-11	Terminal 2-5 voltage signal bias rate	-100.0%~100.0%	0.0%	<a href="#">102</a>
P.142	04-07	Speed 8	Same as 04-03(P.24)	99999	<a href="#">135</a>
P.143	04-08	Speed 9	Same as 04-03(P.24)	99999	<a href="#">135</a>
P.144	04-09	Speed 10	Same as 04-03(P.24)	99999	<a href="#">135</a>
P.145	04-10	Speed 11	Same as 04-03(P.24)	99999	<a href="#">135</a>
P.146	04-11	Speed 12	Same as 04-03(P.24)	99999	<a href="#">135</a>
P.147	04-12	Speed 13	Same as 04-03(P.24)	99999	<a href="#">135</a>
P.148	04-13	Speed 14	Same as 04-03(P.24)	99999	<a href="#">135</a>
P.149	04-14	Speed 15	Same as 04-03(P.24)	99999	<a href="#">135</a>

Parameter Number	Group	Name	Setting Range	Default	Page
P.150	10-08	Restart mode selection	XX0: No frequency search.	0	<u>218</u>
			XX1: Direct frequency search		
			XX2: Decrease voltage mode		
			X0X: Power on once.		
			X1X: Start each time.		
			X2X: Only instantaneous stop and restart		
			0XX: No rotation direction detection.		
			1XX: Rotation direction detection.		
			2XX:00-15(P.78)=0, rotation direction detection ; 00-15(P.78)=1/2, no rotation direction detection.		
P.151	10-03	Zero-speed control function selection	0: Off.	0	<u>216</u>
			1: In close-loop vector control (00-21(P.300)/00-22(P.370)=4) mode do zero-speed; In V/F close-loop control (00-21(P.300)/00-22(P.370)=1) mode do DC voltage breaking.		
			2: In close-loop vector mode do zero-servo.		
P.152	10-04	Voltage at zero-speed control	0 ~ 30.0%: 7.5K and below	4.0%	<u>216</u>
			0 ~ 30.0%: From 11K~22K	2.0%	
P.153	07-10	COM1 communication alarm action	0: Alarm and stop freely	1	<u>171</u>
			1: No alarm and continuing to operation		
P.154	07-07	COM1 Modbus communication format	0: 1、7、N、2 (Modbus, ASCII)	4	<u>171</u>
			1: 1、7、E、1 (Modbus, ASCII)		
			2: 1、7、O、1 (Modbus, ASCII)		
			3: 1、8、N、2 (Modbus, RTU)		
			4: 1、8、E、1 (Modbus, RTU)		
			5: 1、8、O、1 (Modbus, RTU)		
P.155	06-08	Over torque detection level	0 ~ 200.0%	0.0%	<u>158</u>
P.156	06-09	Over torque detection time	0.1 ~ 60.0s	1.0s	<u>158</u>
P.157	03-17	Digital input terminal filter time	0 ~ 2000ms	8ms	<u>125</u>
P.158	03-18	Digital input terminal enable when power on	0: When power on digital terminals work directly	0	<u>125</u>
			1:When power on digital terminals work after switch off then on		
P.159	10-17	Energy-saving control function	0: Off.	0	<u>223</u>
			1: Energy-saving mode.		
P.160	06-11	Stall level when restart	0 ~ 150.0%	100.0%	<u>159</u>
P.161	00-07	Multi-function display	0: Output AC voltage (V)	0	<u>69</u>
			1: Voltage between (+/P) and (-/N) terminals. (V)		
			2: Inverter temperature rising accumulation rate (%)		
			3: Target pressure of the constant pressure system (%)		
			4: Feedback pressure of the constant pressure system (%)		
			5: Running frequency (Hz)		

Appendix 1 Parameter table

Parameter Number	Group	Name	Setting Range	Default	Page
P.161	00-07	Multi-function display	6: Electronic thermal accumulation rate (%)	0	<u>69</u>
			7: Signal value (V) of 2-5 input terminals.		
			8: Signal value (mA) of 4-5 input terminals (mA/V).		
			9: Output power (kW).		
			10: PG card feedback rotation speed. (Hz)		
			11: Forward reverse rotation signal. 1: forward rotation 2: reverse rotation 0: stop.		
			12: NTC temperature (°C)		
			13: Motor electronic thermal accumulation rate (%)		
			14: Reserved.		
			15: Input frequency of terminal HDI. (kHz)		
			16: Real-time roll diameter. (mm)		
			17: Real-time line speed. (m/min)		
			18: Output torque of inverter (%) (Valid only when 00-21 (P. 300) or 00-22 (P. 370) is set to 3 ~ 6 )		
			19: Digital terminal input state		
			20: Digital terminal output state		
			21: Actual working carrier frequency		
			22: Reserved		
			23: Synchronous motor rotor pole position ( Show motor rotor magnetic pole position from encoder feedback, valid when 00-21 (P. 300) = 5)		
			24: Current target frequency		
			25: PTC input percentage		
			26: Target pressure and feedback pressure from the constant pressure system		
			27: Motor rotation speed		
			28: Power factor		
29: Power accumulation rate (kWh)					
30: PG feedback rotation speed					
31: Motor rotor position (Z pulse as 0)					
32: PG card feedback A1 B1 pulse count					
33: PG card feedback A2 B2 pulse count					
P.162	01-28	Middle frequency 2	0 ~ 650.00Hz	99999	<u>90</u>
			99999: Off		
P.163	01-29	Output voltage 2 of middle frequency	0 ~ 100.0%	0.0%	<u>90</u>
P.164	01-30	Middle frequency 3	0 ~ 650.00Hz	99999	<u>90</u>
			99999: Off		
P.165	01-31	Output voltage 3 of middle frequency	0 ~ 100.0%	0.0%	<u>90</u>
P.166	01-32	Middle frequency 4	0 ~ 650.00Hz	99999	<u>90</u>
			99999: Off		
P.167	01-33	Output voltage 4 of middle frequency	0 ~ 100.0%	0.0%	<u>90</u>

Parameter Number	Group	Name	Setting Range	Default	Page
P.168	01-34	Middle frequency 5	0 ~ 650.00Hz	99999	<u>90</u>
			99999: Off		
P.169	01-35	Output voltage 5 of middle frequency	0 ~ 100.0%	0.0%	<u>90</u>
P.170	08-00	PID function selection	0: Off	0	<u>192</u>
			0X: Parameter 08-03(P.225) as target value.		
			1X: Terminal 2-5 input as target source		
			2X: Terminal 4-5 input as target source		
			4X: Terminal M2 input as target source		
			X1: Terminal 2-5 input as feedback source		
X2: Terminal 4-5 input as feedback source					
P.171	08-01	PID feedback control method	0: Negative feedback control.	0	<u>192</u>
			1: Positive feedback control.		
P.172	08-04	Proportional gain	0.1% ~ 1000.0%	20.0%	<u>192</u>
P.173	08-05	Integral time	0 ~ 60.00s	1.00s	<u>192</u>
P.174	08-06	Differential time	0 ~ 10000ms	0ms	<u>193</u>
P.175	08-07	Abnormal deviation	0 ~ 100.0%	0.0%	<u>193</u>
P.176	08-08	Abnormal duration time	0 ~ 600.0s	30.0s	<u>193</u>
P.177	08-09	Abnormal processing mode	0: Stop freely	0	<u>193</u>
			1: Slow down to stop		
			2: Alarm and continue operation		
P.178	08-10	Sleep detection deviation	0 ~ 100.0%	0.0%	<u>193</u>
P.179	08-11	Sleep detection duration time	0 ~ 255.0s	1.0s	<u>193</u>
P.180	08-12	Wake-up level	0 ~ 100.0%	90.0%	<u>193</u>
P.181	08-13	Stop level	0 ~ 120.00Hz	40.00Hz	<u>193</u>
P.182	08-14	Upper integral limit	0 ~ 200.0%	100.0%	<u>193</u>
P.183	08-15	Deceleration step length when stable	0 ~ 10.00Hz	0.50Hz	<u>193</u>
P.184	02-24	Terminal 4-5 disconnect selection	0: Off	0	<u>108</u>
			1: Inverter decelerates to 0Hz, multi-function digital output terminal set off alarm		
			2: Inverter stops immediately, and keypad displays "AEr" alarm		
			3: Inverter runs continuously according to the frequency reference before disconnection. Digital output terminal will set off alarm.		
P.185	02-06	Proportional linkage gain	0 ~ 100%	0%	<u>100</u>
P.186	00-23	Motor types selection	0: Normal Duty (ND), on fan and pump duty type.	1	<u>75</u>
			1: Heavy Duty (HD), apply to other duties.		
P.187	02-59	FM calibration coefficient	0 ~ 9998	450	<u>114</u>
P.188	00-01	Firmware version	Read only	Read only	<u>62</u>

Appendix 1 Parameter table

Parameter Number	Group	Name	Setting Range	Default	Page
P.189	00-24	50Hz/60Hz switch selection	0: Frequency related parameter default value is 60Hz.	0	<u>75</u>
			1: Frequency related parameter default value is 50Hz.	1	
P.190	02-47	Terminal AM output bias	0 ~ 1024	0	<u>111</u>
P.191	02-46	Terminal AM output gain	0 ~ 1024	935	<u>111</u>
P.192	02-12	Terminal 2-5 minimum input positive voltage	0 ~ 10.00V	0.00V	<u>102</u>
P.193	02-13	Terminal 2-5 maximum input positive voltage	0 ~ 10.00V	10.00V	<u>102</u>
P.194	02-14	Percentage corresponds to terminal 2-5 minimum positive voltage	-100.0% ~ 100.0%	0.0%	<u>102</u>
			-400.0% ~ 400.0% ( P.500 = 2/14/15/16/17 )		
P.195	02-15	Percentage corresponds to terminal 2-5 maximum positive voltage	-100.0% ~ 100.0%	100.0%	<u>102</u>
			-400.0% ~ 400.0% ( P.500 = 2/14/15/16/17 )		
P.196	02-27	Percentage corresponds to terminal 4-5 minimum input current/ voltage	-100.0 ~ 100.0%	0.0%	<u>108</u>
			-400.0% ~ 400.0% ( P.500 = 2/14/15/16/17 )		
P.197	02-28	Percentage corresponds to terminal 4-5 maximum input current/ voltage	-100.0 ~ 100.0%	100.0%	<u>108</u>
			-400.0% ~ 400.0% ( P.500 = 2/14/15/16/17 )		
P.198	02-25	Terminal 4-5 minimum input current/ voltage	0 ~ 20.00mA	4.00mA	<u>108</u>
P.199	02-26	Terminal 4-5 maximum input current/ voltage	0 ~ 20.00mA	20.00 mA	<u>108</u>
P.215	01-43	Second base voltage	0 ~ 1000.0V 99999: Fluctuate with input voltage	99999	<u>89</u>
P.216	13-05	Acceleration torque boost	-60.0 ~ 60.0%	0.0%	<u>257</u>
P.219	01-40	Remote frequency acceleration/deceleration time selection	0: Use current acc/dec time	0	<u>92</u>
			1: Use second acc/dec time		
P.220	06-04	Current stall selection of time of acceleration and deceleration	X0: According to the current time of Acc/Dec	3	<u>154</u>
			X1: According to the first time of Acc/Dec		
			X2: According to the second time of Acc/Dec		
			X3: Automatically calculate the best time of acceleration/deceleration		
			0X: Current stall frequency reduction is invalid during acceleration/constant speed/deceleration		
1X: Current stall frequency reduction is valid during constant speed					

Parameter Number	Group	Name	Setting Range	Default	Page
P.220	06-04	Current stall selection of time of acceleration and deceleration	2X: Current stall frequency reduction is valid during acceleration	3	<u>154</u>
			3X: Current stall frequency reduction is valid during acceleration and constant speed		
			4X: Current stall frequency reduction is valid during deceleration		
			5X: Current stall frequency reduction is valid during deceleration and constant speed		
			6X: Current stall frequency reduction is valid during acceleration and deceleration		
			7X: Current stall frequency reduction is valid during acceleration/constant speed/deceleration		
P.225	08-03	PID target value	0 ~ 08-43(P.251)	20.0%	<u>192</u>
P.229	10-18	Dwell function selection	0: Off.	0	<u>224</u>
			1: Backlash compensation function.		
			2: Acceleration and deceleration interrupt waiting function.		
P.230	10-19	Dwell frequency at acceleration	0 ~ 650.00Hz	1.00Hz	<u>224</u>
P.231	10-20	Dwell time at acceleration	0 ~ 360.0s	0.5s	<u>224</u>
P.232	10-21	Dwell frequency at deceleration	0 ~ 650.00Hz	1.00Hz	<u>224</u>
P.233	10-22	Dwell time at deceleration	0 ~ 360.00s	0.5s	<u>224</u>
P.234	10-23	Triangular wave function selection	0: Off.	0	<u>225</u>
			1: If terminal function TRI is triggered, triangular wave function will on.		
			2: Triangular wave function is on at all time.		
P.235	10-24	Maximum amplitude	0 ~ 25.0%	10.0%	<u>225</u>
P.236	10-25	Amplitude compensation at deceleration	0 ~ 50.0%	10.0%	<u>225</u>
P.237	10-26	Amplitude compensation at acceleration	0 ~ 50.0%	10.0%	<u>225</u>
P.238	10-27	Amplitude acceleration time	0 ~ 360.00s/0 ~ 3600.0s	10.00s	<u>225</u>
P.239	10-28	Amplitude deceleration time	0 ~ 360.00s/0 ~ 3600.0s	10.00s	<u>225</u>
P.240	02-07	Auxiliary frequency	0: Off	0	<u>101</u>
			1: Output frequency = basic frequency + auxiliary frequency (given by terminal 2-5)		
			2: Output frequency = basic frequency + auxiliary frequency (given by terminal 4-5)		
			3: Output frequency = basic frequency - auxiliary frequency (given by terminal 2-5)		
			4: Output frequency = basic frequency - auxiliary frequency (given by 4-5 terminal)		
			5: Output frequency = proportional linkage signal (given by terminal 2-5)		
6: Output frequency = proportional linkage signal (given by terminal 4-5)					

Appendix 1 Parameter table

Parameter Number	Group	Name	Setting Range	Default	Page
P.241	08-02	PID sampling period	0 ~ 60000ms	20ms	<a href="#">192</a>
P.242	10-05	DC brake before inverter start	0: Off	0	<a href="#">217</a>
			1: Before starting operate DC brake first.		
P.243	10-06	DC brake time before inverter start	0 ~ 60.0s	0.5s	<a href="#">217</a>
P.244	10-07	DC brake voltage before inverter start	0 ~ 30.0%: 7.5K (included) and below	4.0%	<a href="#">217</a>
			0 ~ 30.0%: 11K ~ 22K	2.0%	
P.245	06-12	Cooling fan operation	0: Fan turn on when inverter starts running. Fan turn off 30 seconds after inverter stops	0	<a href="#">159</a>
			1: Fan turn on when inverter power on. Fan turn off when inverter power off.		
			2: Fan turn on if heat sink temperature is higher than 60°C when running. Fan turn off when stop or heat sink temperature is lower than 40°C		
			3: Fan turn on if heat sink temperature is higher than 60°C. Fan turn off when heat sink temperature is lower than 40°C		
P.246	13-01	Modulation coefficient	0.90 ~ 1.20	1.00	<a href="#">256</a>
P.247	10-29	Switch to commercial supply MC switchover interlock time	0.1 ~ 100.0s	1.0s	<a href="#">226</a>
P.248	10-30	Switch to commercial supply waiting time	0.1 ~ 100.0s	0.5s	<a href="#">226</a>
P.249	10-31	From inverter to commercial power supply switchover frequency	0 ~ 60.00Hz	99999	<a href="#">226</a>
			99999: Off.		
P.250	10-32	Automatic switchover frequency range	0~10.00Hz: After switching from inverter operation to commercial power supply operation, after inverter start command (STF/STR) is OFF, switch to inverter operation.	99999	<a href="#">226</a>
			99999: After switching from inverter operation to commercial power supply operation, after inverter start command (STF/STR) is OFF, switch to inverter operation, and slow down to stop.		
P.251	08-43	Pressure unit (Bar) setting	1.0~100.0	100	<a href="#">201</a>
P.253	08-45	Feedback disconnection detection time	0 ~ 600.0 s	0.0s	<a href="#">202</a>
P.254	08-46	Feedback disconnection processing method	0: AEr alarm is reported and the inverter stops freely	0	<a href="#">202</a>
			1: After deceleration to stop, AEr alarm is reported		
			2: Continue to run, output disconnection alarm is reported around multifunction digital output terminal		
P.255	01-36	S curve time at the beginning of acceleration	0 ~ 25.00s/0 ~ 250.0s	0.20s	<a href="#">90</a>



Parameter Number	Group	Name	Setting Range	Default	Page
P.256	01-37	S curve time at the end of acceleration	0 ~ 25.00s/0 ~ 250.0s	99999	<u>90</u>
			99999: Off		
P.257	01-38	S curve time at the beginning of deceleration	0 ~ 25.00s/0 ~ 250.0s	99999	<u>90</u>
			99999: Off		
P.258	01-39	S curve time at the end of deceleration	0 ~ 25.00s/0 ~ 250.0s	99999	<u>90</u>
			99999: Off		
P.259	00-09	Multi-function display unit selection	X0: Speed display unit is 1	1	<u>70</u>
			X1: Speed display unit is 0.1		
			0X: Power accumulation rate unit is 1		
			1X: Power accumulation rate unit is 0.1		
			2X: Power accumulation rate unit is 0.01		
P.260	06-10	Action when detect over torque	0: OL2 alarm will not be reported after over torque detection, and inverter keeps running.	1	<u>158</u>
			1: OL2 alarm will be reported after over torque detection, and inverter stops.		
P.261	06-17	Maintenance alarm function	0: Off	0	<u>161</u>
			1 ~ 9998day: Used to set the time for maintenance alarm output signal		
P.262	06-20	Output phase loss protection	0: Off	0	<u>162</u>
			1: When output phase loss, inverter stops and alarms LF.		
P.263	06-07	Decrease carrier protection setting	0: Fixed carrier frequency, and limit output current according to carrier value.	0	<u>156</u>
			1: Fixed rated current, and limit carrier according to output current and temperature.		
P.264	10-51	Over excitation deceleration	0: Off.	0	<u>233</u>
			1: Over excitation deceleration is valid.		
P.265	10-52	Over excitation current level	0 ~ 150.0%	100.0%	<u>233</u>
P.266	10-53	Over excitation gain	1.00 ~ 1.40	1.10	<u>233</u>
P.267	10-45	Regeneration avoid function selection	0: Off.	0	<u>232</u>
			1: Regeneration avoid function is always on. (Automatic calculate Acc/Dec speed )		
			2: Regeneration avoid function is on only during constant speed operation (Automatic calculate Acc/Dec speed )		
			11: Regeneration avoid function is always on. (Manual mode, Acc/Dec speed is set by 10-49(P.271) and 10-50(P.272))		
			12: Regeneration avoid function is on only during constant speed operation (Manual mode, Acc/Dec speed is set by 10-49(P.271) and 10-50(P.272))		
P.268	10-46	Regeneration avoid action voltage level	155 ~ 400V: 220V model	380V	<u>232</u>
			310 ~ 800V: 440V model	760V	

Appendix 1 Parameter table

Parameter Number	Group	Name	Setting Range	Default	Page
P.269	10-47	Regeneration avoid function DC bus voltage detection sensitivity at deceleration	0: Prevent regeneration avoidance from failing according to bus voltage change rate	0	<a href="#">232</a>
			1 ~ 5: Set the sensitivity to detect the bus voltage change rate. Larger number, higher sensitivity.		
P.270	10-48	Regeneration avoid frequency compensation value	0 ~ 10.00Hz: Set the limit value of regenerative avoid frequency compensation.	6.00Hz	<a href="#">232</a>
			99999: Off.		
P.271	10-49	Regeneration avoid voltage gain coefficient	0 ~ 400.0%/0~40.00%	100.0%	<a href="#">232</a>
P.272	10-50	Regeneration avoid frequency gain coefficient	0 ~ 400.0%/0~40.00%	100.0%	<a href="#">232</a>
P.273	10-33	When input power fail stop option	0: Off.	0	<a href="#">229</a>
			1: No undervoltage avoidance (If undervoltage or power fail, the motor decelerates to stop.)		
			2: No undervoltage avoidance (If undervoltage or power fail, the motor decelerates to stop. Motor re-accelerates if power restores during the deceleration to stop.)		
			11: Undervoltage avoidance (If undervoltage or power fail, the motor decelerates to stop.)		
			12: Undervoltage avoidance (If undervoltage or power fail, the motor decelerates to stop. Motor re-accelerates if power restores during the deceleration to stop.)		
P.274	10-34	When input power fail subtracted frequency at deceleration start	0 ~ 20.00Hz	3.00Hz	<a href="#">229</a>
P.275	10-35	When input power fail subtraction starting frequency	0 ~ 120.00Hz: When output frequency ≥ 10-35 (P.275), Motor decelerates from “output frequency - 10-34(P.274)” ; When output frequency < 10-35 (P.275), deceleration from output frequency	50.00Hz	<a href="#">229</a>
			99999: Motor decelerates from “output frequency - 10-34(P.274)”		
P.276	10-36	Deceleration time during input power failure 1	0 ~ 360.00s/0 ~ 3600.00s	5.00s	<a href="#">229</a>
P.277	10-37	Deceleration time during input power failure 2	0~360.00s//0~3600.0s: Set deceleration time below the set frequency of 10-38 (P.278)	99999	<a href="#">229</a>
			99999: Set deceleration time to the set frequency of 10-38 (P.278)		
P.278	10-38	Power failure deceleration time switchover frequency	0 ~ 650.00Hz	50.00Hz	<a href="#">229</a>
P.279	10-39	UV avoidance voltage gain	0 ~ 200.0%	100.0%	<a href="#">229</a>

Parameter Number	Group	Name	Setting Range	Default	Page
P.280	06-18	Short circuit to ground detection when starting	X0: When given run command to inverter, inverter does not detect short circuit to ground	10	161
			X1: When given run command to inverter, inverter detects short circuit to ground		
			0X: When given run command to inverter, inverter does not detect short circuit between phase		
			1X:When given run command to inverter, inverter detects short circuit between phase		
P.281	06-13	Input phase loss protection	0: Off	0	160
			1: When input phase loss, inverter stops and alarms IPF		
P.282	06-19	GF detection level when running	0~100.0%	50.0%	161
P.285	13-02	Low frequency vibration suppression factor	0 ~ 8	5	257
P.286	13-03	High frequency vibration suppression factor	XX00 ~ XX15	509	257
			00XX ~15XX		
P.287	06-14	SCP Short circuit protection function	0: Off	1	160
			1:When output side is short, inverter stops and alarms SCP.		
P.288	06-40	Alarm record code query	Choose 0 ~ 12 recorded alarm	1	165
P.289	06-41	Alarm record code display	Read only	Read	165
P.290	06-42	Alarm record message query	Choose 0 ~ 10 recorded alarm	0	165
P.291	06-43	Alarm record message display	Read only	Read	165
P.292	06-27	Total inverter operation time (minutes)	0 ~ 1439 min	0min	164
P.293	06-28	Total inverter operation time (days)	0 ~ 9999day	0day	164
P.294	00-04	Password parameter	0~65535	0	65
P.295	00-05	Password setup	2~65535	0	65
P.296	06-29	Total inverter power on time (minutes)	0 ~ 1439 min	0min	164
P.297	06-30	Total inverter power on time (days)	0 ~ 9999 day	0day	164
P.298	06-31	Output power(lower 16 bit)	Read only	Read	164
P.299	06-32	Output power(higher 16 bit)	Read only	Read	164
P.300	00-21	Motor control mode selection	0: Induction motor V/F control	0	74
			1: Induction motor closed-loop V/F control (VF + PG)		
			2: Induction motor simple vector control		
			3: Induction motor sensorless vector control		
			4: Induction motor PG vector control		
			5: Synchronous motor PG vector control		
			6: Synchronous motor vector control without PG		

Appendix 1 Parameter table

Parameter Number	Group	Name	Setting Range	Default	Page
P.301	05-00	Motor specifications automatic measurement	0: Off	0	<u>142</u>
			1: Induction motor specifications automatic measurement 1 (Run motor to measure)		
			2: Induction motor specifications automatic measurement 2 (Don't run motor to measure)		
			3: Induction motor specifications automatic measurement (Measure when operating)		
			4: Reserve		
			5 : Induction motor specifications automatic measurement 3 (Don't run motor to measure)		
			8: Synchronous motor specifications automatic measurement (Run motor to measure)		
			9: Synchronous motor phase Z position automatic measurement (Run motor to measure)		
			10: Induction motor/synchronous motor inertia automatic measurement		
P.302	05-01	Motor rated power	0 ~ 650.00kW	0.00kW	<u>145</u>
P.303	05-02	Motor poles	0 ~ 256	4	<u>145</u>
P.304	05-03	Motor rated voltage	440 Voltage : 0 ~ 510V	According to voltage	<u>145</u>
			220 Voltage : 0~255V		
P.305	05-04	Motor rated frequency	50Hz system: 0 ~ 650.00Hz	50.00Hz	<u>145</u>
			60Hz system: 0 ~ 650.00Hz	60.00Hz	
P.306	05-05	Motor rated current	0~500.00A	According to frame	<u>145</u>
P.307	05-06	Motor rated rotation speed	50Hz system: 0 ~ 65000r/min	1410 r/min	<u>145</u>
			60Hz system: 0 ~ 65000r/min	1710 r/min	
P.308	05-07	Motor excitation current	0~500.00A	According to frame	<u>145</u>
P.309	05-08	IM motor stator resistance	0 ~ 65000mΩ	According to kW	<u>145</u>
P.310	05-09	IM motor rotor resistance	0 ~ 65000mΩ	According to kW	<u>145</u>
P.311	05-10	IM motor leakage inductance	0 ~ 6500.0mH	According to kW	<u>145</u>
P.312	05-11	IM motor mutual inductance	0 ~ 6500.0mH	According to kW	<u>145</u>
P.313	05-12	PM motor stator resistance	0 ~ 65000mΩ	According to kW	<u>145</u>
P.314	05-13	PM motor d-axis inductance	0 ~ 650.00mH	According to kW	<u>145</u>
P.315	05-14	PM motor q-axis inductance	0 ~ 650.00mH	According to kW	<u>145</u>
P.316	05-15	PM motor Back-EMF coefficient	0 ~ 6500.0V/krpm	According to kW	<u>145</u>

Parameter Number	Group	Name	Setting Range	Default	Page
P.317	05-16	PM motor Phase Z origin pulse compensation	0 ~ 359.9°	0.0°	<a href="#">145</a>
P.318	05-17	Motor inertia	0 ~ 6500.0kg. cm2: 5.5K and below	According to kW	<a href="#">147</a>
			0 ~ 65000kg. cm2: 7.5K~ 22K		
P.319	05-18	Load inertia ratio	0~600.0	1.0	<a href="#">147</a>
P.320	11-00	Speed control proportion coefficient 1	0 ~ 200.00	10.00	<a href="#">237</a>
P.321	11-01	Speed control integral time 1	0 ~ 20.000s	0.50s	<a href="#">237</a>
P.322	11-02	PI coefficient switchover frequency 1	11-25 ( P.414 ) ~ 11-05 ( P.325 ) Hz	5.00Hz	<a href="#">237</a>
P.323	11-03	Speed control proportional coefficient 2	0 ~ 200.0	10.0	<a href="#">237</a>
P.324	11-04	Speed control integral time 2	0 ~ 20.000s	0.50s	<a href="#">237</a>
P.325	11-05	PI coefficient switchover frequency 2	11-02 (P.322) ~ 650.00Hz	10.00Hz	<a href="#">237</a>
P.326	11-06	Current control proportional coefficient	0 ~ 20	0	<a href="#">237</a>
P.327	11-07	PM motor types	0: SPM	0	<a href="#">238</a>
			1: IPM		
P.328	11-08	PM motor initial position detection method	0: Pull in.	0	<a href="#">238</a>
			1: High frequency pulse		
P.329	11-09	PM motor acceleration id	0 ~ 200%	80%	<a href="#">238</a>
P.330	11-10	PM motor constant speed id	0 ~ 200%	0%	<a href="#">238</a>
P.331	11-11	PM motor estimated speed filtering time	0 ~ 1000ms	2ms	<a href="#">238</a>
P.332	05-22	Second motor rated power	0 ~ 650.00kW	99999	<a href="#">148</a>
			99999		
P.333	05-23	Second motor poles	0 ~ 256	99999	<a href="#">148</a>
			99999		
P.334	05-24	Second motor rated voltage	440 Voltage : 0 ~ 510V	99999	<a href="#">148</a>
			220 Voltage : 0~255V		
			99999		
P.335	05-25	Second motor rated frequency	0 ~ 650.00Hz	99999	<a href="#">148</a>
			99999		
P.336	05-26	Second motor rated frequency	0~500.00A: Below Frame D	99999	<a href="#">148</a>
			99999		
P.337	05-27	Second motor rated current	0 ~ 65000r/min	99999	<a href="#">148</a>
			99999		
P.338	05-28	Second motor excitation current	0~500.00A	99999	<a href="#">148</a>
			99999		
P.339	05-29	Second motor (IM) stator resistance	0 ~ 65000mΩ	99999	<a href="#">148</a>
			99999		
P.340	05-30	Second motor (IM) rotor resistance	0 ~ 65000mΩ	99999	<a href="#">148</a>
			99999		

Appendix 1 Parameter table

Parameter Number	Group	Name	Setting Range	Default	Page
P.341	05-31	Second motor (IM) leakage inductance	0 ~ 6500.0mH	99999	<a href="#">148</a>
			99999		
P.342	05-32	Second motor (IM)mutual inductance	0 ~ 6500.0mH	99999	<a href="#">148</a>
			99999		
P.343	05-33	Second motor (PM) stator resistance	0 ~ 65000mΩ	99999	<a href="#">148</a>
			99999		
P.344	05-34	Second motor (PM) d-axis inductance	0 ~ 650.00mH	99999	<a href="#">148</a>
			99999		
P.345	05-35	Second motor (PM)q-axis inductance	0 ~ 650.00mH	99999	<a href="#">148</a>
			99999		
P.346	05-36	Second motor (PM) Back-EMF coefficient	0 ~ 6500.0V/krpm	99999	<a href="#">149</a>
			99999		
P.347	05-37	Second motor (PM) Phase Z origin pulse compensation	0 ~ 359.9°	99999	<a href="#">149</a>
			99999		
P.349	09-00	Encoder type	0 : ABZ	0	<a href="#">204</a>
			1 : ABZ (For synchronous motor)		
			2 : Resolver 1x synchronous motor standard encoder		
			3 : ABZ/UVW synchronous motor standard encoder		
P.350	09-01	Encoder pulse 1	0 ~ 20000	1024	<a href="#">205</a>
P.351	09-02	Encoder input type 1	0 : Off	0	<a href="#">205</a>
			1 : A/Phase B pulse wave , forward spin if Phase A is over Phase B for 90 degrees		
			2 : A/Phase B pulse wave , forward spin if Phase B is over Phase A for 90 degrees.		
			3 : Phase A :pulse wave , Phase B:directional sign , L:reverse spin , H:forward spin		
			4 : Phase A :pulse wave , Phase B: directional sign , L:forward spin , H:reverse spin		
P.352	09-03	PG error detection time	0 ~ 100.0s	1.0s	<a href="#">206</a>
P.353	09-04	Overspeed detection frequency	0 ~ 30.00Hz	4.00Hz	<a href="#">206</a>
P.354	09-05	Overspeed detection time	0 ~ 100.0s	1.0s	<a href="#">206</a>
P.355	09-06	Encoder pulse 2	0 ~ 20000	2500	<a href="#">207</a>
P.356	09-07	Encoder input type 2	0 : Off	0	<a href="#">207</a>
			1 : A/Phase B pulse wave, forward spin if Phase A is over Phase B for 90 degrees		
			2 : A/Phase B pulse wave , forward spin if Phase B is over Phase A for 90 degrees		
			3 : Phase A :pulse wave , Phase B:directional sign , L:reverse spin , H:forward spin		
			4 : Phase A :pulse wave , Phase B: directional sign , L:forward spin , H:reverse spin		

Parameter Number	Group	Name	Setting Range	Default	Page
P.357	09-08	Frequency division output setting	1 ~ 255	1	<a href="#">208</a>
P.358	09-09	Frequency division filter coefficient setting	0 ~ 255	0	<a href="#">208</a>
P.359	09-10	Electronic gear ratio	0 ~ 65.535	1.000	<a href="#">208</a>
P.360	09-11	Anti-reversal detection pulse	0 ~ 65535	0	<a href="#">208</a>
P.361	09-12	Reversal detection frequency	0 ~ 65535	0	<a href="#">208</a>
P.362	10-54	Short-circuit brake time when PM motor start	0~60.0s	0.0s	<a href="#">233</a>
P.363	09-14	Z phase correction allowance	0.0° : Off	15.0°	<a href="#">209</a>
			0.1°~360.0° : Z phase pulse correction		
P.364	09-15	Z phase DV1/DV2 alarm enabled	0 : Off	1	<a href="#">209</a>
			1 : Z phase DV1/DV2 alarm valid		
P.366	11-43	PM motor speed estimation observer Kp	0 ~ 65000	30	<a href="#">243</a>
P.367	11-44	PM motor speed estimation observer Ki	0 ~ 65000	10000	<a href="#">243</a>
P.370	00-22	Second motor control mode selection	0: Induction motor V/F control	99999	<a href="#">74</a>
			1: Induction motor close-loop V/F control (VF+PG)		
			2: Induction motor simple vector control		
			3: Induction motor sensorless vector control		
			4: Induction motor PG vector control		
			5: Synchronous motor PG vector control		
			6: Synchronous motor vector control without PG		
			99999: Off		
P.371	11-30	Second motor speed control proportional coefficient 1	0 ~ 200.00	100.0	<a href="#">242</a>
			99999		
P.372	11-31	Second motor speed control integral time 1	0 ~ 20.00s	0.30s	<a href="#">242</a>
			99999		
P.373	11-32	Second motor PI coefficient switchover frequency 1	0 ~ 11-35 (P.376)Hz	5.00Hz	<a href="#">242</a>
			99999		
P.374	11-33	Second motor speed control proportional coefficient 2	0 ~ 2000.0	10.00	<a href="#">242</a>
			99999		
P.375	11-34	Second motor speed control integral time 2	0 ~ 20.00s	0500s	<a href="#">242</a>
			99999		
P.376	11-35	Second motor PI coefficient switchover frequency 2	11-32(P.373)~650.00Hz	10.00Hz	<a href="#">242</a>
			99999		
P.377	11-36	Second motor current control proportional coefficient	0 ~ 20	0	<a href="#">242</a>
			99999		
P.378	11-37	Second PM motor type	0: SPM	0	<a href="#">243</a>
			1: IPM		
			99999		

Appendix 1 Parameter table

Parameter Number	Group	Name	Setting Range	Default	Page	
P.379	11-38	Second PM motor initial position detection method	0: Pull in.	0	<a href="#">243</a>	
			1: High frequency pulse			
			99999			
P.380	11-39	Second PM motor acceleration id	0 ~ 200%	80%	<a href="#">243</a>	
			99999			
P.381	11-40	Second PM motor constant speed id	0 ~ 200%	0%	<a href="#">243</a>	
			99999			
P.382	11-41	Second PM motor estimated speed filtering time	0 ~ 1000ms	2ms	<a href="#">243</a>	
			99999			
P.386	09-16	Encoder signal detection setting	1 digit : PG302L hardware disconnection check	0 : Off	1	<a href="#">206</a>
				1 : Valid		
			2 digit : A1/B1 phase sequence check	0 : Off		
				1 : Valid		
P.387	11-48	Speed loop zero speed bandwidth	0~100.0Hz	5.0Hz	<a href="#">244</a>	
P.388	11-49	Speed loop low speed bandwidth	0~100.0Hz	5.0Hz	<a href="#">244</a>	
P.389	11-50	Speed loop high speed bandwidth	0~100.0Hz	5.0Hz	<a href="#">244</a>	
P.390	11-51	Speed loop self-tuning selection	0: Off	0	<a href="#">244</a>	
			1: Speed loop self-setting is effective			
P.391	05-19	Inertia identification speed limit	0~100%	50%	<a href="#">147</a>	
P.392	05-20	Acceleration and deceleration time of inertia identification	0 ~ 20.0s	2.0s	<a href="#">147</a>	
P.393	05-21	Operation mode of inertia identification	0: one direction rotation	1	<a href="#">147</a>	
			1: both direction rotation			
P.394	05-38	Second motor inertia	0 ~ 6500.0kg. cm2: 5.5k and below	99999	<a href="#">149</a>	
			0 ~ 65000kg. cm2: 7.5k ~ 22K model			
			99999			
P.395	05-39	Second motor load inertia ratio	0~600.0	99999	<a href="#">149</a>	
			99999			
P.400	00-20	Control mode selection	0: Speed control	0	<a href="#">73</a>	
			1: Torque control			
			2: Position control			
P.401	11-12	Torque command	-400.0 ~ 400.0%	0.0%	<a href="#">239</a>	
P.402	11-13	Speed limit	-120% ~ 120%	0%	<a href="#">239</a>	
P.403	11-14	Speed limit bias	0 ~ 120%	10%	<a href="#">239</a>	
P.404	11-15	Torque filter time	0 ~ 1000ms	0ms	<a href="#">239</a>	
P.405	11-16	Torque command source	0: Given by 11-12(P.401).	0	<a href="#">239</a>	
			1: Given by analog or pulse input.			
			2: Given by communication mode.			



Parameter Number	Group	Name	Setting Range	Default	Page
P.406	11-17	Speed limit selection	0: Speed is limited according to 11-13 (P.402) and 11-14 (P.403)	0	<a href="#">239</a>
			1: Frequency command source(it is decided according to 00-16(P.79) )		
P.407	11-18	Unidirectional speed limit bias	0: Off	1	<a href="#">239</a>
			1: Unidirectional speed limit bias is valid.		
P.408	11-19	Forward-rotation electronic torque limit	0 ~ 400.0%	200.0%	<a href="#">241</a>
P.409	11-20	Reverse-rotation regenerative torque limit	0 ~ 400.0%	200.0%	<a href="#">241</a>
P.410	11-21	Reverse-rotation electronic torque limit	0 ~ 400.0%	200.0%	<a href="#">241</a>
P.411	11-22	Forward-rotation regenerative torque limit	0 ~ 400.0%	200.0%	<a href="#">241</a>
P.412	11-23	Zero-speed proportional coefficient	0~200.00	10.0	<a href="#">237</a>
P.413	11-24	Zero-speed integral time	0~20.000s	0.500s	<a href="#">237</a>
P.414	11-25	Zero-speed switching frequency	0~11-02 ( P.322 ) Hz	5.00Hz	<a href="#">237</a>
P.415	11-26	IM motor estimated speed filtering time	0-100.00ms	4.0ms	<a href="#">238</a>
P.416	09-17	Encoder installation transmission ratio	0 ~ 65.535	1.000	<a href="#">210</a>
P.420	12-00	Homing mode	0 ~ 2123	0	<a href="#">247</a>
P.421	12-01	Homing,first high speed	0 ~ 650.00Hz	10.00Hz	<a href="#">247</a>
P.422	12-02	Homing,second high speed	0 ~ 650.00Hz	2.00Hz	<a href="#">247</a>
P.423	12-03	Pulse deviation of original point	-30000~30000	0	<a href="#">247</a>
P.424	12-04	Position instruction source	0: External pulse.	0	<a href="#">250</a>
			1: Relative position.		
			2: Absolute position.		
P.425	12-05	Position control proportional gain	0 ~ 65535	10	<a href="#">250</a>
P.426	12-06	Position control feed-forward gain coefficient	0 ~ 65535	0	<a href="#">250</a>
P.427	12-07	Position control feed forward low pass filter time	0 ~ 65535ms	100ms	<a href="#">250</a>
P.428	12-08	External pulse position control speed limit	0 ~ 650.00Hz	10.00Hz	<a href="#">250</a>
P.429	12-09	Position reach margin	0 ~ 65535	40	<a href="#">250</a>
P.430	12-10	Zero servo gain	0 ~ 100	5	<a href="#">252</a>
P.431	12-11	Single point positioning location	0~65535	0	<a href="#">252</a>
P.432	12-12	Single point positioning frequency	0~650.00Hz	0.00Hz	<a href="#">252</a>
P.433	12-13	Zero speed threshold	0~650.00Hz	0.50Hz	<a href="#">250</a>
P.434	12-14	Position command response option	0~2	0	<a href="#">250</a>
P.440	11-58	PM motor id given low-pass filter time constant	0 ~ 65.535s	0.200s	<a href="#">254</a>
P.450	12-20	Cycle number of position command 1	-30000~30000	0	<a href="#">253</a>
P.451	12-21	Pulse number of position command 1	-30000~30000	0	<a href="#">253</a>
P.452	12-22	Cycle number of position command 2	-30000~30000	0	<a href="#">253</a>

Appendix 1 Parameter table

Parameter Number	Group	Name	Setting Range	Default	Page
P.453	12-23	Pulse number of position command	-30000~30000	0	<a href="#">253</a>
P.454	12-24	Cycle number of position command 3	-30000~30000	0	<a href="#">253</a>
P.455	12-25	Pulse number of position command 3	-30000~30000	0	<a href="#">253</a>
P.456	12-26	Cycle number of position command 4	-30000~30000	0	<a href="#">253</a>
P.457	12-27	Pulse number of position command 4	-30000~30000	0	<a href="#">253</a>
P.458	12-28	Cycle number of position command 5	-30000~30000	0	<a href="#">253</a>
P.459	12-29	Pulse number of position command 5	-30000~30000	0	<a href="#">253</a>
P.460	12-30	Cycle number of position command 6	-30000~30000	0	<a href="#">254</a>
P.461	12-31	Pulse number of position command 6	-30000~30000	0	<a href="#">254</a>
P.462	12-32	Cycle number of position command 7	-30000~30000	0	<a href="#">254</a>
P.463	12-33	Pulse number of position command 7	-30000~30000	0	<a href="#">254</a>
P.464	12-34	Cycle number of position command 8	-30000~30000	0	<a href="#">254</a>
P.465	12-35	Pulse number of position command 8	-30000~30000	0	<a href="#">254</a>
P.466	12-36	Cycle number of position command 9	-30000~30000	0	<a href="#">254</a>
P.467	12-37	Pulse number of position command 9	-30000~30000	0	<a href="#">254</a>
P.468	12-38	Cycle number of position command 10	-30000~30000	0	<a href="#">254</a>
P.469	12-39	Pulse number of position command 10	-30000~30000	0	<a href="#">254</a>
P.470	12-40	Cycle number of position command 11	-30000~30000	0	<a href="#">254</a>
P.471	12-41	Pulse number of position command 11	-30000~30000	0	<a href="#">254</a>
P.472	12-42	Cycle number of position command 12	-30000~30000	0	<a href="#">254</a>
P.473	12-43	Pulse number of position command 12	-30000~30000	0	<a href="#">254</a>
P.474	12-44	Cycle number of position command 13	-30000~30000	0	<a href="#">254</a>
P.475	12-45	Pulse number of position command 13	-30000~30000	0	<a href="#">254</a>
P.476	12-46	Cycle number of position command 14	-30000~30000	0	<a href="#">254</a>
P.477	12-47	Pulse number of position command 14	-30000~30000	0	<a href="#">254</a>
P.478	12-48	Cycle number of position command 15	-30000~30000	0	<a href="#">254</a>
P.479	12-49	Pulse number of position command 15	-30000~30000	0	<a href="#">254</a>
P.500	02-00	Function selection of terminal 2-5	0: Off	1	<a href="#">98</a>
			1: Frequency command		
			2: Torque command		
			3: PID target value		
			4: PID feedback signal		
			5: Tension target value		
			6: Line speed		
			7: Line speed feedback		
			8: Real-time roll diameter		
			9: Initial roll diameter		
			10: Material thickness		
			11: PTC thermistor		
			12: PT100 thermistor		
			13: VF separate function		
			14: Positive torque limit		
			15: Negative torque limit		
			16: Positive/Negative torque limit		
17: Regenerative torque limit					

Parameter Number	Group	Name	Setting Range	Default	Page
P.501	02-01	Terminal 4-5 input function	Same as 02-00(P.500)	1	<u>98</u>
P.503	02-03	Terminal HDI input function	Same as 02-00(P.500)	0	<u>98</u>
P.505	02-23	Terminal 4-5 current/ voltage signal bias rate	-100.0% ~ 100.0%	0.0%	<u>107</u>
P.510	02-18	Percentage corresponds to terminal 2-5 minimum negative voltage	-100.0% ~ 100.0%	0.0%	<u>102</u>
			-400.0% ~ 400.0% ( 02-00(P.500)= 2 /14 /15 /16 /17 )		
P.511	02-19	Percentage corresponds to terminal 2-5 maximum negative voltage	-100.0 ~ 100.0%	0.0%	<u>102</u>
			400.0% ~ 400.0% ( 02-00(P.500) = 2 /14 /15/16/17 )		
P.512	02-16	Terminal 2-5 minimum input negative voltage	0 ~ 10.00V	0.00V	<u>102</u>
P.513	02-17	Terminal 2-5 maximum input negative voltage	0 ~ 10.00V	0.00V	<u>102</u>
P.522	02-41	Percentage corresponds to terminal HDI minimum input frequency	-100.0% ~ 100.0%	0.0%	<u>109</u>
			400.0% ~ 400.0% ( 02-03(P.503)= 2/14/15/16/17 )		
P.523	02-42	Percentage corresponds to terminal HDI maximum input frequency	-100.0% ~ 100.0%	100.0%	<u>109</u>
			400.0% ~ 400.0% ( 02-03(P.503)= 2/14/15/16/17 )		
P.524	02-39	Terminal HDI minimum input frequency	0 ~ 100.00kHz	0.00kHz	<u>109</u>
P.525	02-40	Terminal HDI maximum input frequency	0 ~ 100.00kHz	100.00kHz	<u>109</u>
P.526	02-38	Terminal HDI filter time	0 ~ 2000ms	10ms	<u>109</u>
P.528	02-22	Terminal 4-5 filter time	0 ~ 2000ms	30ms	<u>107</u>
P.533	06-15	PTC alarm action	0: Alarm and continue to run	0	<u>160</u>
			1: Alarm and decelerate to stop		
			2: Alarm and stop freely		
			3: No alarm		
P.534	06-16	Percentage of PTC level	0 ~ 100.0%	0.0%	<u>160</u>
P.541	02-54	Terminal AM/FM fixed output level	0 ~ 100.0%	0.0%	<u>113</u>
P.543	02-44	Terminal FM output function selection	0: Output frequency, use 02-51 (P.55) value as 100%.	0	<u>111</u>
			1: Output current, use 02-52 (P.56) value as 100%.		
			2: Output DC bus voltage, use the OV trigger voltage as 100%.		
			3: Output inverter temperature accumulate rising rate, use NTC trigger level as 100%.		

Appendix 1 Parameter table

Parameter Number	Group	Name	Setting Range	Default	Page
P.543	02-44	Terminal FM output function selection	4: Output inverter thermal relay accumulate rate, use the digital thermal relay trigger level ( 06-00 ( P.9 ) ≠ 0 ) or the thermal relay on IGBT trigger level ( 06-00 (P.9) = 0 ) as 100%.	0	<u>111</u>
			5: Target frequency, use 02-51(P.55) value as 100%.		
			6: Fixed output, voltage or current output level can be set by 02-54 (P.541)		
			7: Output voltage, use inverter rated voltage as 100%		
			8: Excitation current, use motor rated current as 100%. (Valid only when 00-21(P.300) or 00-22 (P.370) is set to 3~6)		
			9: Output torque, use two times motor rated torque as 100%. (Valid only when 00-21 (P.300) or 00-22 (P.370) is set to 3~6)		
			10: Output power, use two times motor rated power as 100%.		
			11: High-speed pulse input, use 100KHz as 100%.		
			12: Motor speed, use 02-51 (P.55) as 100%		
P.551	03-25	Expanded digital input terminal M10	Same as 03-00(P.83)	99999	<u>130</u>
P.552	03-26	Expanded digital input terminal M11	Same as 03-00(P.83)	99999	<u>130</u>
P.553	03-27	Expanded digital input terminal M12	Same as 03-00(P.83)	99999	<u>130</u>
P.554	03-28	Expanded digital input terminal M13	Same as 03-00(P.83)	99999	<u>129</u>
P.555	03-29	Expanded digital input terminal M14	Same as 03-00(P.83)	99999	<u>130</u>
P.556	03-30	Expanded digital input terminal M15	Same as 03-00(P.83)	99999	<u>130</u>
P.567	03-41	Expanded digital input terminal logic	0 ~ 63	0	<u>131</u>
P.568	03-42	Expanded digital output terminal A10	Same as 03-10(P.40)	99999	<u>131</u>
P.569	03-43	Expanded digital output terminal A11	Same as 03-10(P.40)	99999	<u>131</u>
P.570	03-44	Expanded digital output terminal A12	Same as 03-10(P.40)	99999	<u>131</u>
P.571	03-45	Expanded digital output terminal A13	Same as 03-10(P.40)	99999	<u>131</u>
P.572	03-46	Expanded digital output terminal A14	Same as 03-10(P.40)	99999	<u>131</u>
P.573	03-47	Expanded digital output terminal A15	Same as 03-10(P.40)	99999	<u>131</u>

Parameter Number	Group	Name	Setting Range	Default	Page
P.574	03-48	Expanded digital output terminal A16	Same as 03-10(P.40)	99999	<a href="#">131</a>
P.575	03-49	Expanded digital output terminal A17	Same as 03-10(P.40)	99999	<a href="#">131</a>
P.585	03-59	Monitor inverter digital input terminal state	Read	Read	<a href="#">132</a>
P.586	03-60	Monitor inverter and expansion card digital output terminal state	Read	Read	<a href="#">132</a>
P.587	03-61	Monitor expansion card input terminal state	Read	Read	<a href="#">132</a>
P.592	02-55	PT100 thermistor voltage level 1	0 ~ 10.00V	5.00V	<a href="#">113</a>
P.593	02-56	PT100 thermistor voltage level 2	0 ~ 10.00V	7.00V	<a href="#">113</a>
P.594	02-57	PT100 thermistor level 1 frequency	0 ~ 650.00Hz	0.00Hz	<a href="#">113</a>
P.595	02-58	PT100 thermistor level 1 delay time	0 ~ 6000s	60s	<a href="#">113</a>
P.600	14-00	Tension control parameter	0 : Off	0	<a href="#">260</a>
			1 : Open loop torque control mode ( under closed loop vector control mode )		
P.600	14-00	Tension control parameter	2 : Closed loop speed control mode	0	<a href="#">260</a>
			3 : Closed loop torque control mode ( under closed loop vector control mode )		
			4 : Constant linear speed control mode		
P.601	14-01	Rolling mode	0 : Wind roll	0	<a href="#">260</a>
			1 : Release roll		
P.602	14-02	Tightening roll option when releasing	0 : Forbid tightening material during startup	0	<a href="#">260</a>
			1 : Allow tightening material during startup		
P.603	14-03	Mechanical transmission ratio	0 ~ 300.00	1.00	<a href="#">260</a>
P.604	14-04	Tension setting source	0: The parameter 14-05(P.605) setting.	0	<a href="#">261</a>
			1: The analog value or PULSE input setting.		
			2: Communication setting.		
P.605	14-05	Tension setting	0 ~ 30000N	0N	<a href="#">261</a>
P.606	14-06	Maximum tension	0 ~ 30000N	0N	<a href="#">261</a>
P.607	14-07	Zero-speed tension increase	0 ~ 50.0%	0.0%	<a href="#">261</a>
P.608	14-08	Zero-speed threshold	0 ~ 30.00Hz	0.00Hz	<a href="#">261</a>
P.609	14-09	Tension taper	0 ~ 100.0%	0.0%	<a href="#">261</a>

Appendix 1 Parameter table

Parameter Number	Group	Name	Setting Range	Default	Page
P.610	14-11	Winding radius calculation method options	0 : Calculate by linear speed	0	<a href="#">262</a>
			1 : Calculate by thickness(encoder of motor side) , pulse signal connects to A1/B1 of PG card		
			2 : Calculate by thickness (encoder of winding shaft) , pulse signal input to terminal HDI		
			3 : Analog value of pulse input		
P.611	14-13	Maximum winding radius	1 ~ 10000mm	500mm	<a href="#">262</a>
P.612	14-14	Winding diameter	0 ~ 10000mm	100mm	<a href="#">262</a>
P.613	14-15	Initial winding radius source	0 : Initial winding radius is determined by parameter 14-16(P.614) ~ 14-18(P.616)	0	<a href="#">262</a>
			1 : Initial winding radius is determined by analog value		
P.614	14-16	Initial winding radius 1	1 ~ 10000mm	100mm	<a href="#">263</a>
P.615	14-17	Initial winding radius 2	1 ~ 10000mm	100mm	<a href="#">263</a>
P.616	14-18	Initial winding radius 3	1 ~ 10000mm	100mm	<a href="#">263</a>
P.617	14-19	Winding radius filter time	0 ~ 1000ms	0ms	<a href="#">263</a>
P.618	14-20	Current winding radius	0 ~ 10000mm	0mm	<a href="#">263</a>
P.619	14-21	Pulse per cycle	1 ~ 60000	1	<a href="#">263</a>
P.620	14-22	Cycle per layer	1 ~ 10000	1	<a href="#">263</a>
P.621	14-23	Material thickness setting source	0 : Material thickness is set by parameter 14-24 ( P.622 ) ~ 14-27 ( P.625 )	0	<a href="#">263</a>
			1 : Material thickness is determined analog value		
P.622	14-24	Material thickness 0	0.01 ~ 100.00mm	0.01mm	<a href="#">263</a>
P.623	14-25	Material thickness 1	0.01 ~ 100.00mm	0.01mm	<a href="#">263</a>
P.624	14-26	Material thickness 2	0.01 ~ 100.00mm	0.01mm	<a href="#">263</a>
P.625	14-27	Material thickness 3	0.01 ~ 100.00mm	0.01mm	<a href="#">263</a>
P.626	14-28	Maximum thickness	0.01 ~ 100.00mm	1.00mm	<a href="#">263</a>
P.627	14-29	Linear speed input source	0 : Off	0	<a href="#">265</a>
			1 : Analog value or pulse input		
			2 : Communication setting		
P.628	14-30	Maximum linear speed	0.1 ~ 6500.0m/min	1000.0m/min	<a href="#">265</a>
P.629	14-31	Calculate R minimum linear speed	0.1 ~ 6500.0m/min	200.0 m/min	<a href="#">265</a>
P.630	14-32	Actual line speed	0 ~ 6500.0m/min	0.0m/min	<a href="#">265</a>
P.633	14-33	Mechanical inertia compensation coefficient	0 ~ 65535	0	<a href="#">265</a>
P.634	14-34	Material density	0 ~ 60000kg/m <sup>3</sup>	0kg/m <sup>3</sup>	<a href="#">265</a>
P.635	14-35	Material width	0 ~ 60000mm	0mm	<a href="#">265</a>

Parameter Number	Group	Name	Setting Range	Default	Page
P.636	14-36	Friction compensation coefficient	0 ~ 50.0%	0.0%	<a href="#">265</a>
P.637	14-37	Material outage detection function	0 : Off	0	<a href="#">265</a>
			1 : Material outage detection function 1		
			2 : Material outage detection function 2		
			3 : Material outage detection function 3		
P.638	14-38	Minimum speed detection	0.1 ~ 6500.0m/min	200.0 m/min	<a href="#">265</a>
P.639	14-39	Error range detection	0.1 ~ 100.0%	10.0%	<a href="#">265</a>
P.640	14-40	Delay detection	0.1 ~ 60.0s	2.0s	<a href="#">265</a>
P.641	08-20	Proportional gain P2	0.1% ~ 1000.0%	20.0%	<a href="#">197</a>
P.642	08-21	Integral time I2	0 ~ 60.00s	1.00s	<a href="#">197</a>
P.643	08-22	Differential time D2	0 ~ 10000ms	0ms	<a href="#">197</a>
P.644	08-23	Auto adjustment for PID parameters	0: Adjust according to the feedback deviation value	0	<a href="#">197</a>
			1: Adjust according to the curling radius.		
			2: Adjust according to the operation frequency		
			3: Adjust according to the line speed		
P.645	14-41	Pre-drive speed gain	-50.0% ~ 50.0%	0.0%	<a href="#">268</a>
P.646	14-42	Pre-drive torque increase	-50.0% ~ 50.0%	0.0%	<a href="#">268</a>
P.647	14-43	Pre-drive delay	0 ~ 65535 ms	0ms	<a href="#">268</a>
P.650	14-12	Curling radius memory control when calculation through thickness accumulation	0: It does not memorize the curling radius when turning off the power or stopping calculating the curling radius.	0	<a href="#">259</a>
			1: It memorizes previous calculation value when turning off the power or stopping calculating the curling radius, it takes the memorized curling radius as initial value when re-turning on the power or beginning to calculate.		
P.654	14-10	Taper compensation correction value	0 ~ 10000mm	0mm	<a href="#">261</a>
P.656	14-44	Linear speed setting source	0 : Off	0	<a href="#">270</a>
			1 : Obtain linear speed via analog value or pulse input		
			2 : Obtain linear speed via communication		
P.657	14-45	Linear speed setting	0 ~ 6500.0m/min	0.0m/min	<a href="#">270</a>
P.658	14-46	Closed-loop tension limit standard	0 : Use rated frequency of motor as standard of limitation	0	<a href="#">270</a>
			1 : Use system linear speed as standard of limitation		
P.659	14-47	Closed-loop tension limit deviation	0.0% ~ 100.0%	0.0%	<a href="#">270</a>
P.700	10-40	VF separated voltage source	0: Given by digital 10-41(P.701).	0	<a href="#">231</a>
			1: Given by analog or HDI pulse signal.		
P.701	10-41	VF separated voltage digital	0 ~ 440.00V/0~220.00V	According to voltage	<a href="#">231</a>

Appendix 1 Parameter table

Parameter Number	Group	Name	Setting Range	Default	Page
P.702	10-42	VF separated voltage Acc time	0 ~ 1000.0s	0.0s	<a href="#">231</a>
P.703	10-43	VF separated voltage Dec time	0 ~ 1000.0s	0.0s	<a href="#">231</a>
P.704	10-44	VF separated stop selection	0: Frequency/voltage independently decreases to 0.	0	<a href="#">231</a>
			1: After the voltage decreases to 0, frequency decreases.		
P.705	06-21	Low voltage level	220V inverter : 155 ~ 220V	155V	<a href="#">162</a>
			440V inverter : 310 ~ 440V	310V	
P.706	06-22	Regenerative brake operation level	220V inverter : 205 ~ 400V	360V	<a href="#">162</a>
			440V inverter : 410 ~ 800V	720V	
P.707	06-23	Voltage stall level	220V inverter : 205 ~ 400V	380V	<a href="#">163</a>
			440V inverter : 410 ~ 800V	760V	
P.708	06-24	Capacitor lifetime detection	0: Off	0	<a href="#">163</a>
			1: When the power is OFF, start to detect the lifetime of capacitor on main circuit.		
P.709	06-25	Capacitor lifetime detection level	0 ~ 100.0%	100.0%	<a href="#">163</a>
P.710	06-26	Capacitor lifetime detection result	0: Normal.	Read only	<a href="#">163</a>
			1: Electrolytic capacitor abnormal.		
P.711	08-24	PID target signal filter time	0 ~ 650.00s	0.00s	<a href="#">198</a>
P.712	08-25	PID feedback signal filter time	0 ~ 60.00s	0.00s	<a href="#">198</a>
P.713	08-26	PID output signal filter time	0 ~ 60.00s	0.00s	<a href="#">198</a>
P.714	08-27	PID deviation control limit	0 ~ 100.00%	0.00%	<a href="#">198</a>
P.715	08-28	Integral separated property	0: Off	0	<a href="#">199</a>
			1: Integral separated		
P.716	08-29	Integral separated point	0 ~ 100.00%	50.00%	<a href="#">199</a>
P.717	08-30	PID differential limit	0 ~ 100.00%	0.10%	<a href="#">199</a>
P.718	08-31	PID output positive deviation limit	0 ~ 100.00%	100.00%	<a href="#">199</a>
P.719	08-32	PID output negative deviation limit	0 ~ 100.00%	100.00%	<a href="#">199</a>
P.720	08-33	PID parameter switchover operation selection	0: No PID parameter switchover.	0	<a href="#">200</a>
			1: PID parameter switchover based on deviation.		
P.721	08-34	PID parameter switchover deviation lower limit	0 ~ 100.00%	20.00%	<a href="#">200</a>
P.722	08-35	PID parameter switchover deviation upper limit	0 ~ 100.00%	80.00%	<a href="#">200</a>
P.723	08-36	PID disconnection operation option 1	0: Select no need to run to the upper limit when PID is disconnected	1	<a href="#">200</a>
			1: Select need to run to the upper limit when PID is disconnected		
P.726	08-39	PID counting when inverter stop action selection	0: PID stop counting when inverter stop	0	<a href="#">200</a>
			1: PID keep counting when inverter stop		
P.727	08-40	PID allowed reverse rotation action selection	0: PID does not allow reverse rotation	0	<a href="#">201</a>
			1: PID allows reverse rotation		



Parameter Number	Group	Name	Setting Range	Default	Page
P.728	08-41	PID in reverse direction integral limit	0 ~ 100.0%	0.0%	<u>201</u>
P.729	08-42	PID minimum output frequency	0 ~ 10.00Hz	0.00Hz	<u>201</u>
P.740	06-44	E1	Read only	Read	<u>166</u>
P.741	06-45	E2	Read only	Read	<u>166</u>
P.742	06-46	E3	Read only	Read	<u>166</u>
P.743	06-47	E4	Read only	Read	<u>166</u>
P.744	06-48	E5	Read only	Read	<u>166</u>
P.745	06-49	E6	Read only	Read	<u>166</u>
P.746	06-50	E7	Read only	Read	<u>166</u>
P.747	06-51	E8	Read only	Read	<u>166</u>
P.748	06-52	E9	Read only	Read	<u>166</u>
P.749	06-53	E10	Read only	Read	<u>166</u>
P.750	06-54	E11	Read only	Read	<u>166</u>
P.751	06-55	E12	Read only	Read	<u>166</u>
P.752	06-56	Output frequency during E1 alarm	Read only	Read	<u>167</u>
P.753	06-57	Output current during E1 alarm	Read only	Read	<u>167</u>
P.754	06-58	Output voltage during E1 alarm	Read only	Read	<u>167</u>
P.755	06-59	Temperature rising accumulation rate during E1 alarm	Read only	Read	<u>167</u>
P.756	06-60	PN voltage during E1 alarm	Read only	Read	<u>167</u>
P.757	06-61	Total inverter operation time during E1 alarm	Read only	Read	<u>167</u>
P.758	06-62	Inverter operation status code during E1 alarm	Read only	Read	<u>167</u>
P.759	06-63	E1 alarm date (years / months)	Read only	Read	<u>167</u>
P.760	06-64	E1 alarm date (days/hours)	Read only	Read	<u>167</u>
P.761	06-65	E1 alarm date (minutes / seconds)	Read only	Read	<u>167</u>
P.766	06-70	Output frequency during E2 alarm	Read only	Read	<u>167</u>
P.767	06-71	Output current during E2 alarm	Read only	Read	<u>167</u>
P.768	06-72	Output voltage during E2 alarm	Read only	Read	<u>167</u>
P.769	06-73	Temperature rising accumulation rate during E2 alarm	Read only	Read	<u>167</u>
P.770	06-74	PN voltage during E2 alarm	Read only	Read	<u>167</u>
P.771	06-75	Total inverter operation time during E2 alarm	Read only	Read	<u>167</u>
P.772	06-76	Inverter operation status code during E2 alarm	Read only	Read	<u>167</u>
P.773	06-77	E2 alarm date (years / months)	Read only	Read	<u>167</u>
P.774	06-78	E2 alarm date (days/hours)	Read only	Read	<u>167</u>
P.775	06-79	E2 alarm date (minutes / seconds)	Read only	Read	<u>167</u>
P.780	10-55	PLC function selection	0: Off 1: PLC RUN signal from digital input terminal function 60 or 10-56 (P.781)。 2 : PLC RUN signal from digital input terminal function 60	0	<u>234</u>

Appendix 1 Parameter table

Parameter Number	Group	Name	Setting Range	Default	Page
P.781	10-56	PLC run	0: Off	0	<a href="#">234</a>
			1: PLC RUN		
P.782	10-57	PLC program erase function	0: Off	0	<a href="#">234</a>
			1: Erase the PLC program, after erase success parameter value is 0.		
P.783	10-58	PLC choose register to monitor	0~329	0	<a href="#">234</a>
P.784	10-59	PLC register monitoring value	Read only	Read	<a href="#">234</a>
P.800	07-15	CANopen slave address	0 ~ 127	0	<a href="#">188</a>
P.801	07-16	CANopen rate	0: 1Mbps	0	<a href="#">188</a>
			1: 500Kbps		
			2: 250Kbps		
			3: 125Kbps		
			4: 100Kbps		
			5: 50 Kbps		
P.802	07-17	CANopen communication status	0: Node retry status	0	<a href="#">188</a>
			1: Communication retry status		
			2: Retry completion status		
			4: stop state		
			5: operation status		
			127: pre-operational status		
P.803	07-18	CANopen control status	0: Boot not completed status	0	<a href="#">188</a>
			1: Forbidden operation state		
			2: Pre-excitation status		
			3: Excitation state		
			4: Allowed operating status		
			7: Quick action stop status		
			13: Trigger error action status		
			14: Error status		
P.810	07-25	PU communication protocol selection	0: Modbus protocol	1	<a href="#">171</a>
			1: Shihlin protocol		
			2: PLC protocol (Effective when using Shihlin built-in PLC)		
P.811	07-26	PU inverter communication station number	0 ~ 254	0	<a href="#">171</a>
P.812	07-27	PU Serial communication baud rate	0 : Baud rate 4800bps	1	<a href="#">172</a>
			1 : Baud rate 9600bps		
			2 : Baud rate 19200bps		
			3 : Baud rate 38400bps		
			4 : Baud rate 57600bps		
			5 : Baud rate 115200bps		
P.813	07-28	PU data length	0 : 8bit	0	<a href="#">172</a>
			1 : 7bit		
P.814	07-29	PU stop bit	0 : 1bit	0	<a href="#">172</a>
			1 : 2bit		
P.815	07-30	PU Parity check option	0 : no odd-even check	0	<a href="#">172</a>
			1 : odd check		
			2 : even check		
P.816	07-31	PU CR/LF choose	1 : only CR	1	<a href="#">172</a>
			2 : CR,LF Both		

Parameter Number	Group	Name	Setting Range	Default	Page
P.817	07-32	PU Modbus communication format	0 : 1, 7, N, 2 (Modbus, ASCII)	4	<u>172</u>
			1 : 1, 7, E, 1 (Modbus, ASCII)		
			2 : 1, 7, O, 1 (Modbus, ASCII)		
			3 : 1, 8, N, 2 (Modbus, RTU)		
			4 : 1, 8, E, 1 (Modbus, RTU)		
			5 : 1, 8, O, 1 (Modbus, RTU)		
P.818	07-33	PU Number of communication retries	0 ~ 10	1	<u>172</u>
P.819	07-34	PU communication interval allowed time	0~999.8s: Check communication timeout with the set value	99999	<u>172</u>
			99999: Off		
P.820	07-35	Expansion communication card communication error handling	0: Alarm and idling and stopping	1	<u>172</u>
			1: No alarm and continue running		
P.826	07-41	Outside enlarge communication cartoon - exception permit number	0 ~ 10	1	<u>172</u>
P.827	07-42	Outside enlarge communication cartoon - error handling	0 : Alarm and stop idling	1	<u>172</u>
			1 : no alarm and keep on running		
P.828	07-43	Expansion communication card communication interval allowed time	0~999.8s: Check communication timeout with the set value	99999	<u>172</u>
			99999: Off		
P.829	07-44	Version of EP301 communication card	Read only	read	<u>189</u>
P.830	07-45	IP configuration	0: Static IP	0	<u>189</u>
			1: Dynamic IP		
P.831	07-46	IP address 1	0~255	192	<u>189</u>
P.832	07-47	IP address 2	0~255	168	<u>189</u>
P.833	07-48	IP address 3	0~255	2	<u>189</u>
P.834	07-49	IP address 4	0~255	102	<u>189</u>
P.835	07-50	Subnet mask 1	0~255	255	<u>189</u>
P.836	07-51	Subnet mask 2	0~255	255	<u>189</u>
P.837	07-52	Subnet mask 3	0~255	255	<u>189</u>
P.838	07-53	Subnet mask 4	0~255	0	<u>189</u>
P.839	07-54	Default gateway 1	0~255	192	<u>189</u>
P.840	07-55	Default gateway 2	0~255	168	<u>189</u>
P.841	07-56	Default gateway 3	0~255	2	<u>189</u>
P.842	07-57	Default gateway 4	0~255	100	<u>189</u>
P.900	15-00	User registered parameter1	P mode: 0 ~ 1299 Parameter group mode: 00-00~15-99	99999	<u>271</u>
P.901	15-01	User registered parameter2		99999	<u>271</u>
P.902	15-02	User registered parameter3		99999	<u>271</u>
P.903	15-03	User registered parameter4		99999	<u>271</u>
P.904	15-04	User registered parameter5		99999	<u>271</u>
P.905	15-05	User registered parameter6		99999	<u>271</u>
P.906	15-06	User registered parameter7		99999	<u>271</u>
P.907	15-07	User registered parameter8		99999	<u>272</u>
P.908	15-08	User registered parameter9		99999	<u>272</u>

Appendix 1 Parameter table

Parameter Number	Group	Name	Setting Range	Default	Page
P.909	15-09	User registered parameter10	P mode: 0 ~ 1299 Parameter group mode: 00-00~15-99	99999	<u>272</u>
P.910	15-10	User registered parameter11		99999	<u>272</u>
P.911	15-11	User registered parameter12		99999	<u>272</u>
P.912	15-12	User registered parameter13		99999	<u>272</u>
P.913	15-13	User registered parameter14		99999	<u>272</u>
P.914	15-14	User registered parameter15		99999	<u>272</u>
P.915	15-15	User registered parameter16		99999	<u>272</u>
P.916	15-16	User registered parameter17		99999	<u>272</u>
P.917	15-17	User registered parameter18		99999	<u>272</u>
P.918	15-18	User registered parameter19		99999	<u>272</u>
P.919	15-19	User registered parameter20		99999	<u>272</u>
P.990	00-25	Parameter display mode setting	0: Parameter is displayed in "group mode"	0	<u>76</u>
			1: Parameter is displayed in "parameter P mode"		
P.991	00-27	Frequency mode setting	0: Normal mode	0	<u>76</u>
			1: High speed mode		
P.996 ~ P.999	00-02	Parameter restoration	0: Off	0	<u>63</u>
			1: Clear alarm history (P.996=1)		
			2: Reset inverter (P.997=1)		
			3: Restore all parameters to default (P.998=1)		
			4: Restore some parameters to default 1 (P.999=1)		
			5: Restore some parameters to default 2 (P.999=2)		
6: Restore some parameters to default 3 (P.999=3)					

## 7.1.2 Group mode

Group	Parameter Number	Name	Setting Range	Default	Page
00-00	P.90	Inverter model	Read only	Read only	<u>62</u>
00-01	P.188	Firmware version	Read only	Read only	<u>62</u>
00-02	P.996 ~ P.999	Parameter restoration	0: Off	0	<u>63</u>
			1: Clear alarm history (P.996=1)		
			2: Reset inverter (P.997=1)		
			3: Restore all parameters to default (P.998=1)		
			4: Restore some parameters to default 1 (P.999=1)		
			5: Restore some parameters to default 2 (P.999=2)		
00-03	P.77	Selection of parameters write protection	0: Parameters can be written only when the motor stops.	0	<u>65</u>
			1: Parameters cannot be written.		
			2: Parameters can also be written when the motor is running.		
			3: Parameters cannot be read when in password protection.		
00-04	P.294	Password parameter	0~65535	0	<u>65</u>
00-05	P.295	Password setup	2~65535	0	<u>65</u>
00-06	P.110	Keypad selection monitor	X0: When inverter starts, keypad enters monitor mode automatically, screen displays output frequency.	1	<u>69</u>
			X1: When inverter starts, screen displays steady state frequency.		
			X2: When inverter starts, keypad enters monitor mode automatically, screen displays current pressure and feedback pressure of the constant pressure system in percentage		
			X5 : When inverter starts, keypad enters monitor mode automatically, screen displays current pressure and feedback pressure of the constant pressure system		
			0X : Boot screen monitors output frequency		
			1X : Boot screen is in target frequency setting mode		
			2X : Boot screen monitors output current		
			3X : Boot screen monitors output voltage		
00-07	P.161	Multi-function display	0: Output AC voltage (V)	0	<u>69</u>
			1: Voltage between (+/P) and (-/N) terminals. (V)		
			2: Inverter temperature rising accumulation rate (%)		
			3: Target pressure of the constant pressure system (%)		
			4: Feedback pressure of the constant pressure system (%)		
			5: Running frequency (Hz)		
			6: Electronic thermal accumulation rate (%)		
			7: Signal value (V) of 2-5 input terminals.		
			8: Signal value (mA) of 4-5 input terminals (mA/V).		
			9: Output power (kW).		
10: PG card feedback rotation speed. (Hz)					

Appendix 1 Parameter table

Group	Parameter Number	Name	Setting Range	Default	Page
00-07	P.161	Multi-function display	11: Forward reverse rotation signal. 1: forward rotation 2: reverse rotation 0: stop.	0	<u>69</u>
			12: NTC temperature (°C)		
			13: Motor electronic thermal accumulation rate (%)		
			14: Reserved.		
			15: Input frequency of terminal M2. (kHz)		
			16: Real-time roll diameter. (mm)		
			17: Real-time line speed. (m/min)		
			18: Output torque of inverter (%) (Valid only when 00-21 (P. 300) or 00-22 (P. 370) is set to 3 ~ 6 )		
			19: Digital terminal input state		
			20: Digital terminal output state		
			21: Actual working carrier frequency		
			22: Reserved		
			23: Synchronous motor rotor pole position ( Show motor rotor magnetic pole position from encoder feedback, valid when 00-21 (P. 300) = 5)		
			24: Current target frequency		
			25: PTC input percentage		
			26: Target pressure and feedback pressure from the constant pressure system		
			27: Motor rotation speed		
			28: Power factor		
29: Power accumulation rate (kWh)					
30: PG feedback rotation speed					
31: Motor rotor position (Z pulse as 0)					
32: PG card feedback A1 B1 pulse count					
33: PG card feedback A2 B2 pulse count					
00-08	P.37	Speed display	0: Display output frequency(not mechanical speed)	0.0	<u>70</u>
			0.1~5000.0		
			1~50000		
00-09	P.259	Multi-function display unit selection	X0: Speed display unit is 1	1	<u>70</u>
			X1: Speed display unit is 0.1		
			0X: Power accumulation rate unit is 1		
			1X: Power accumulation rate unit is 0.1		
			2X: Power accumulation rate unit is 0.01		
00-11	P.72	Carrier frequency	1~15kHz	5 kHz	<u>70</u>
00-12	P.31	Soft-PWM carrier function selection	0: Off	0	<u>70</u>
			1: When 00-11(P.72)< 5, Soft-PWM is on (only apply to V/F control )		
00-13	P.71	Idling brake / DC brake	0: Idling brake	1	<u>71</u>
			1: DC brake		

Group	Parameter Number	Name	Setting Range	Default	Page
00-14	P.75	Stop function selection	0: Press STOP button and inverter stop running in PU and H2 mode	1	<u>71</u>
			1: Press STOP button and inverter stop running in all mode.		
00-15	P.78	Prevent forward/reverse rotation selection	0: Forward/reverse rotation are both permitted.	0	<u>72</u>
			1: Prevent reverse rotation (Giving reverse signal decelerates and stops the motor).		
			2: Prevent forward rotation (Giving forward signal decelerates and stops the motor).		
00-16	P.79	Operation mode selection	0: "PU mode", "external mode" and "Jog mode" are interchangeable.	0	<u>72</u>
			1: "PU mode" and "JOG mode" are interchangeable.		
			2: "External mode" only		
			3: "Communication mode" only		
			4: "Combined mode 1"		
			5: "Combined mode 2"		
			6: "Combined mode 3"		
			7: "Combined mode 4"		
8: "Combined mode 5"					
99999: Second operation mode, run command is set by 00-18(P.109), target frequency is set by 00-17(P.97)					
00-17	P.97	Second target frequency selection	0: Frequency set by keypad	0	<u>73</u>
			1: Frequency set by RS485 communication		
			2: Frequency set by analog input		
			3: Frequency set by communication expansion card		
			4: Frequency set by PG card A2 B2		
			5: Frequency set by HDI pulse		
00-18	P.109	Second start signal selection	0: Start signal set by keypad	0	<u>73</u>
			1: Start signal set by digital input terminal		
			2: Start signal set by RS485 communication		
			3: Start signal set by communication expansion card		
00-19	P.35	Communication mode selection	0: In communication mode, run signal and frequency is given by communication.	0	<u>73</u>
			1: In communication mode, run signal and frequency is given by external signal.		
00-20	P.400	Control mode selection	0: Speed control	0	<u>73</u>
			1: Torque control		
			2: Position control		
00-21	P.300	Motor control mode selection	0: Induction motor V/F control	0	<u>74</u>
			1: Induction motor closed-loop V/F control (VF + PG)		
			2: Induction motor simple vector control		
			3: Induction motor sensorless vector control		
			4: Induction motor PG vector control		
			5: Synchronous motor PG vector control		
			6: Synchronous motor vector control without PG		

Appendix 1 Parameter table

Group	Parameter Number	Name	Setting Range	Default	Page
00-22	P.370	Second motor control mode selection	0: Induction motor V/F control	99999	<u>74</u>
			1: Induction motor close-loop V/F control (VF+PG)		
			2: Induction motor simple vector control		
			3: Induction motor sensorless vector control		
			4: Induction motor PG vector control		
			5: Synchronous motor PG vector control		
			6: Synchronous motor vector control without PG 99999: Off		
00-23	P.186	Motor types selection	0: Normal Duty (ND), on fan and pump duty type.	1	<u>75</u>
			1: Heavy Duty (HD), apply to other duties.		
00-24	P.189	50Hz/60Hz switch selection	0: Frequency related parameter default value is 60Hz.	0	<u>75</u>
			1: Frequency related parameter default value is 50Hz.	1	
00-25	P.990	Parameter display mode setting	0: Parameter is displayed in "group mode"	0	<u>76</u>
			1: Parameter is displayed in "parameter P mode"		
00-26	P.125	Expansion card type	Read only	Read only	<u>76</u>
00-27	P.991	Frequency mode setting	0: Normal mode	0	<u>76</u>
			1: High speed mode		
01-00	P.1	Maximum frequency	0.00~01-02(P.18)Hz	120.00Hz	<u>80</u>
01-01	P.2	Minimum frequency	0 ~ 120.00Hz	0.00Hz	<u>80</u>
01-02	P.18	High-speed maximum frequency	01-00(P.1) ~ 650.00Hz	120.00Hz	<u>80</u>
01-03	P.3	Base frequency	50Hz system setting: 0 ~ 650.00Hz	50.00Hz	<u>80</u>
			60Hz system setting: 0 ~ 650.00Hz	60.00Hz	
01-04	P.19	Base voltage	0 ~ 1000.0V	99999	<u>80</u>
			99999: Change according to the input voltage		
01-05	P.29	Acceleration/deceleration curve selection	0: Linear acceleration /deceleration curve	0	<u>81</u>
			1: S shape acceleration /deceleration curve 1		
			2: S shape acceleration /deceleration curve 2		
			3: S shape acceleration /deceleration curve 3		
01-06	P.7	Acceleration time	3.7K and below: 0 ~ 360.00s/0 ~ 3600.0s	5.00s	<u>81</u>
			5.5K and above: 0~360.00s/0 ~ 3600.0s	20.00s	
01-07	P.8	Deceleration time	3.7K and below: 0 ~ 360.00s/0 ~ 3600.0s	5.00s	<u>81</u>
			5.5K~7.5K :0 ~ 360.00s/0 ~ 3600.0s	10.00s	
			11K and above:0 ~ 360.00s/0 ~ 3600.0s	30.00s	
01-08	P.21	Acceleration/deceleration time increments	0: Time increment is 0.01s	0	<u>81</u>
			1: Time increment is 0.1s		
01-09	P.20	Acceleration/deceleration reference frequency	50Hz system setting: 1.00 ~ 650.00Hz	50.00Hz	<u>81</u>
			60Hz system setting: 1.00 ~ 650.00Hz	60.00Hz	
01-10	P.0	Torque boost	0.75K and below: 0 ~ 30.0%	6.0%	<u>83</u>
			1.5K ~ 3.7K: 0 ~ 30.0%	4.0%	
			5.5K ~ 7.5K: 0 ~ 30.0%	3.0%	
			11K ~ 22K: 0 ~ 30.0%	2.0%	



Group	Parameter Number	Name	Setting Range	Default	Page
01-11	P.13	Starting frequency	0 ~ 60.00Hz	0.50Hz	<u>84</u>
01-12	P.14	Load pattern selection	0: For constant torque loads (conveyor belt, etc.)	0	<u>84</u>
			1: For variable torque loads (fans and pumps, etc.)		
			2~3: For Lifting loads		
			4: Multipoint V/F curve		
			5~13: Special two-point V/F curve		
			14: V/F complete detached mode		
15: V/F semidetached mode					
01-13	P.15	JOG frequency	0 ~ 650.00Hz	5.00Hz	<u>87</u>
01-14	PP.	JOG acceleration/ deceleration time	0 ~ 360.00s/0 ~ 3600.0s	0.50s	<u>87</u>
01-15	P.28	Output frequency filter time	0 ~ 1000ms	0ms	<u>87</u>
01-16	P.91	Frequency jump 1A	0 ~ 650.00Hz	99999	<u>88</u>
			99999: Off		
01-17	P.92	Frequency jump 1B	0 ~ 650.00Hz	99999	<u>88</u>
			99999: Off		
01-18	P.93	Frequency jump 2A	0 ~ 650.00Hz	99999	<u>88</u>
			99999: Off		
01-19	P.94	Frequency jump 2B	0 ~ 650.00Hz	99999	<u>88</u>
			99999: Off		
01-20	P.95	Frequency jump 3A	0 ~ 650.00Hz	99999	<u>88</u>
			99999: Off		
01-21	P.96	Frequency jump 3B	0 ~ 650.00Hz	99999	<u>88</u>
			99999: Off		
01-22	P.44	Second acceleration time	0 ~ 360.00s/0 ~ 3600.0s	99999	<u>89</u>
			99999: Off		
01-23	P.45	Second deceleration time	0 ~ 360.00s/0 ~ 3600.0s	99999	<u>89</u>
			99999: Off		
01-24	P.46	Second torque boost	0 ~ 30.0%	99999	<u>89</u>
			99999: Off		
01-25	P.47	Second base frequency	0 ~ 650.00Hz	99999	<u>89</u>
			99999: Off		
01-26	P.98	Middle frequency 1	0 ~ 650.00Hz	3.00Hz	<u>90</u>
01-27	P.99	Output voltage 1 of middle frequency	0 ~ 100.0%	10.0%	<u>90</u>
01-28	P.162	Middle frequency 2	0 ~ 650.00Hz	99999	<u>90</u>
			99999: Off		
01-29	P.163	Output voltage 2 of middle frequency	0 ~ 100.0%	0.0%	<u>90</u>
01-30	P.164	Middle frequency 3	0 ~ 650.00Hz	99999	<u>90</u>
			99999: Off		
01-31	P.165	Output voltage 3 of middle frequency	0 ~ 100.0%	0.0%	<u>90</u>
01-32	P.166	Middle frequency 4	0 ~ 650.00Hz	99999	<u>90</u>
			99999: Off		
01-33	P.167	Output voltage 4 of middle frequency	0 ~ 100.0%	0.0%	<u>90</u>
01-34	P.168	Middle frequency 5	0 ~ 650.00Hz	99999	<u>90</u>
			99999: Off		

Appendix 1 Parameter table

Group	Parameter Number	Name	Setting Range	Default	Page
01-35	P.169	Output voltage 5 of middle frequency	0 ~ 100.0%	0.0%	<u>90</u>
01-36	P.255	S curve time at the beginning of acceleration	0 ~ 25.00s/0 ~ 250.0s	0.20s	<u>90</u>
01-37	P.256	S curve time at the end of acceleration	0 ~ 25.00s/0 ~ 250.0s 99999: Off	99999	<u>90</u>
01-38	P.257	S curve time at the beginning of deceleration	0 ~ 25.00s/0 ~ 250.0s 99999: Off	99999	<u>90</u>
01-39	P.258	S curve time at the end of deceleration	0 ~ 25.00s/0 ~ 250.0s 99999: Off	99999	<u>90</u>
<b>01-40</b>	<b>P.219</b>	<b>Remote frequency acc/dec time selection</b>	<b>0: Use current acc/dec time</b> <b>1: Use second acc/dec time</b>	<b>0</b>	<b><u>92</u></b>
<b>01-43</b>	<b>P.215</b>	<b>Second base voltage</b>	<b>0 ~ 100.0V</b> <b>99999: Fluctuate with input voltage</b>	<b>99999</b>	<b><u>89</u></b>
02-00	P.500	Terminal 2-5 input function	0: Off 1: Frequency command 2: Torque command 3: PID target value 4: PID feedback signal 5: Tension target value 6: Line speed 7: Line speed feedback 8: Real-time roll diameter 9: Initial roll diameter 10: Material thickness 11: PTC thermistor 12: PT100 thermistor 13: VF separate function 14: Positive torque limit 15: Negative torque limit 16: Positive/Negative torque limit 17: Regenerative torque limit	1	<u>98</u>
02-01	P.501	Terminal 4-5 input function	Same as 02-00(P.500)	1	<u>98</u>
02-03	P.503	Terminal HDI input function	Same as 02-00(P.500)	0	<u>98</u>
02-04	P.54	Terminal AM output function	0: Output frequency, use 02-51 (P.55) value as 100%. 1: Output current, use 02-52 (P.56) value as 100%. 2: Output DC bus voltage, use the OV trigger voltage as 100%. 3: Output inverter temperature accumulate rising rate, use NTC trigger level as 100%. 4: Output inverter thermal relay accumulate rate, use the digital thermal relay trigger level ( 06-00 ( P.9 ) ≠ 0 ) or the thermal relay on IGBT trigger level ( 06-00 ( P.9 ) = 0 ) as 100%. 5: Target frequency, use 02-51(P.55) value as 100%. 6: Fixed output, voltage or current output level can be set by 02-54 ( P.541 ) 7: Output voltage, use inverter rated voltage as 100% 8: Excitation current, use motor rated current as 100%. (Valid only when 00-21(P.300) or 00-22 ( P.370 ) is set to 3~6)	0	<u>99</u>

Group	Parameter Number	Name	Setting Range	Default	Page
02-04	P.54	Terminal AM output function	9: Output torque, use two times motor rated torque as 100%.(Valid only when 00-21 (P.300) or 00-22 (P.370) is set to 3~6)	0	<u>99</u>
			10: Output power, use two times motor rated power as 100%.		
			11: High-speed pulse input, use 100KHz as 100%.		
			12: Motor speed, use 02-51 (P.55) as 100%		
			13 : PLC analog output, for details please refer to SA3 built-in PLC manual		
02-06	P.185	Proportion linkage gain	0 ~ 100%	0%	<u>100</u>
02-07	P.240	Auxiliary frequency	0: Off	0	<u>101</u>
			1: Output frequency = basic frequency + auxiliary frequency (given by terminal 2-5)		
			2: Output frequency = basic frequency + auxiliary frequency (given by terminal 4-5)		
			3: Output frequency = basic frequency - auxiliary frequency (given by terminal 2-5)		
			4: Output frequency = basic frequency - auxiliary frequency (given by 4-5 terminal)		
			5: Output frequency = proportional linkage signal (given by terminal 2-5)		
			6: Output frequency = proportional linkage signal (given by terminal 4-5)		
02-08	P.73	Terminal 2-5 signal range selection	0: Signal sampling range from 0 ~5V.	1	<u>101</u>
			1: Signal sampling range from 0 ~10V.		
			2: Signal sampling range from 0 ~ -5V.		
			3: Signal sampling range from 0 ~ -10V.		
			4: Signal sampling range from -5 ~ +5V.		
			5: Signal sampling range from -10 ~ +10V.		
02-09	P.38	Terminal 2-5 maximum running frequency	50Hz system: 1.00 ~ 650.00Hz	50.00H z	<u>102</u>
			60Hz system: 1.00 ~ 650.00Hz	60.00H z	
02-10	P.60	Terminal 2-5 filter time	0 ~ 2000ms	30ms	<u>102</u>
02-11	P.139	Terminal 2-5 voltage signal bias rate	-100.0%~100.0%	0.0%	<u>102</u>
02-12	P.192	Terminal 2-5 minimum input positive voltage	0 ~ 10.00V	0.00V	<u>102</u>
02-13	P.193	Terminal 2-5 maximum input positive voltage	0 ~ 10.00V	10.00V	<u>102</u>
02-14	P.194	Percentage corresponds to terminal 2-5 minimum positive voltage	-100.0% ~ 100.0%	0.0%	<u>102</u>
			-400.0% ~ 400.0%(02-00(P.500)= 2/14/15/16/17)		

Appendix 1 Parameter table

Group	Parameter Number	Name	Setting Range	Default	Page
02-15	P.195	Percentage corresponds to terminal 2-5 maximum positive voltage	-100.0% ~ 100.0%	100.0%	<a href="#">102</a>
			-400.0% ~ 400.0%(02-00(P.500)= 2/14/15/16/17)		
02-16	P.512	Terminal 2-5 minimum input negative voltage	0 ~ 10.00V	0.00V	<a href="#">102</a>
02-17	P.513	Terminal 2-5 maximum input negative voltage	0 ~ 10.00V	0.00V	<a href="#">102</a>
02-18	P.510	Percentage corresponds to terminal 2-5 minimum negative voltage	-100.0% ~ 100.0%	0.0%	<a href="#">102</a>
			-400.0% ~ 400.0%(02-00(P.500)= 2/14/15/16/17)		
02-19	P.511	Percentage corresponds to terminal 2-5 maximum negative voltage	-100.0% ~ 100.0%	0.0%	<a href="#">102</a>
			-400.0% ~ 400.0%(02-00(P.500)= 2/14/15/16/17)		
02-20	P.17	Terminal 4-5 signal range selection	0: Signal sampling range from 4~20mA.	0	<a href="#">107</a>
			1: Signal sampling range from 0 ~ 10V.		
			2: Signal sampling range from 0 ~ 5V.		
02-21	P.39	Terminal 4-5 maximum operation frequency	50Hz system: 1.00 ~ 650.00Hz	50.00Hz	<a href="#">107</a>
			60Hz system: 1.00 ~ 650.00Hz	60.00Hz	
02-22	P.528	Terminal 4-5 filter time	0 ~ 2000ms	30ms	<a href="#">107</a>
02-23	P.505	Terminal 4-5 current/ voltage signal bias rate	-100.0% ~ 100.0%	0.0%	<a href="#">107</a>
02-24	P.184	Terminal 4-5 disconnect selection	0: Off	0	<a href="#">108</a>
			1: Inverter decelerates to 0Hz, multi-function digital output terminal set off alarm		
			2: Inverter stops immediately, and keypad displays "AEr" alarm		
			3: Inverter runs continuously according to the frequency command before disconnection. Digital output terminal will set off alarm.		
02-25	P.198	Terminal 4-5 minimum input current/ voltage	0 ~ 20.00mA	4.00mA	<a href="#">108</a>
02-26	P.199	Terminal 4-5 maximum input current/ voltage	0 ~ 20.00mA	20.00mA	<a href="#">108</a>
02-27	P.196	Percentage corresponds to terminal 4-5 minimum input current/ voltage	-100.0% ~ 100.0%	0.0%	<a href="#">108</a>
			-400.0% ~ 400.0%(02-00(P.500)= 2/14/15/16/17)		

Group	Parameter Number	Name	Setting Range	Default	Page
02-28	P.197	Percentage corresponds to terminal 4-5 maximum input current/ voltage	-100.0% ~ 100.0%	100.0%	<u>108</u>
			-400.0% ~ 400.0%(02-00(P.500)= 2/14/15/16/17)		
02-38	P.526	Terminal HDI filter time	0 ~ 2000ms	10ms	<u>109</u>
02-39	P.524	Terminal HDI minimum input frequency	0 ~ 100.00kHz	0.00kHz	<u>109</u>
02-40	P.525	Terminal HDI maximum input frequency	0 ~ 100.00kHz	100.00 kHz	<u>109</u>
02-41	P.522	Percentage corresponds to terminal HDI minimum input frequency	-100.0% ~ 100.0%	0.0%	<u>109</u>
			-400.0% ~ 400.0%(02-00(P.500)= 2/14/15/16/17)		
02-42	P.523	Percentage corresponds to terminal HDI maximum input frequency	-100.0% ~ 100.0%	100.0%	<u>109</u>
			-400.0% ~ 400.0%(02-00(P.500)= 2/14/15/16/17)		
02-43	P.74	Terminal HDO clock multiplier factor	0: Select FM function as the output function of terminal HDO.	0	<u>110</u>
			1 ~ 9000: factor for square-wave pulse output frequency. Value in 02-43 (P.74) times output frequency will be actual output pulse frequency.		
02-44	P.543	Terminal FM output function selection	0: Output frequency, use 02-51 (P.55) value as 100%.	0	<u>111</u>
			1: Output current, use 02-52 (P.56) value as 100%.		
			2: Output DC bus voltage, use the OV trigger voltage as 100%.		
			3: Output inverter temperature accumulate rising rate, use NTC trigger level as 100%.		
			4: Output inverter thermal relay accumulate rate, use the digital thermal relay trigger level ( 06-00 ( P.9 ) ≠ 0 ) or the thermal relay on IGBT trigger level ( 06-00 (P.9) = 0 ) as 100%.		
			5: Target frequency, use 02-51(P.55) value as 100%.		
			6: Fixed output, voltage or current output level can be set by 02-54 (P.541)		
			7: Output voltage, use inverter rated voltage as 100%		
			8: Excitation current, use motor rated current as 100%. (Valid only when 00-21(P.300) or 00-22 (P.370) is set to 3~6)		
			9: Output torque, use two times motor rated torque as 100%.(Valid only when 00-21 (P.300) or 00-22 (P.370) is set to 3~6)		

Appendix 1 Parameter table

Group	Parameter Number	Name	Setting Range	Default	Page
02-44	P.543	Terminal FM output function selection	10: Output power, use two times motor rated power as 100%.	0	<u>111</u>
			11: High-speed pulse input, use 100.00KHz as 100%.		
			12: Motor speed, use 02-51 (P.55) as 100%		
02-45	P.64	Terminal AM output signal selection	0: Output 0~10V across terminal AM-5.	0	<u>111</u>
			1: Reserved		
			2: Output 0~20mA across AM-5.		
			3: Output 4~20mA across AM-5.		
02-46	P.191	Terminal AM output gain	0 ~ 1024	935	<u>111</u>
02-47	P.190	Terminal AM output bias	0 ~ 1024	0	<u>111</u>
02-51	P.55	Maximum analog output frequency reference	50Hz system: 1.00 ~ 650.00Hz	50.00Hz	<u>113</u>
			60Hz system: 1.00 ~ 650.00Hz	60.00Hz	
02-52	P.56	Maximum analog output current reference	0~500.00A	According to type	<u>113</u>
02-54	P.541	Terminal AM/FM fixed output level	0 ~ 100.0%	0.0%	<u>113</u>
02-55	P.592	PT100 thermistor voltage level 1	0 ~ 10.00V	5.00V	<u>113</u>
02-56	P.593	PT100 thermistor voltage level 2	0 ~ 10.00V	7.00V	<u>113</u>
02-57	P.594	PT100 thermistor level 1 frequency	0 ~ 650.00Hz	0.00Hz	<u>113</u>
02-58	P.595	PT100 thermistor level 1 delay time	0 ~ 6000s	60s	<u>113</u>
02-59	P.187	FM calibration coefficient	0 ~ 9998	450	<u>114</u>
03-00	P.83	Terminal STF input function	0: STF(Inverter runs forward)	0	<u>119</u>
			1: STR(Inverter runs reverse)		
			2: RL(Multi-speed low speed)		
			3: RM(Multi-speed medium speed)		
			4: RH(Multi-speed high speed)		
			5:AU( Analog terminal 4-5 high priority)		
			6: External thermal relay actuate		
			7: MRS(Stops inverter output immediately)		
			8: RT(Inverter second function)		
			9: EXT(External JOG)		
			10: STF+EXJ		
			11: STR+EXJ		
			12: STF+RT		
			13: STR+RT		
			14: STF+RL		
			15: STR+RL		
			16: STF+RM		
			17: STR+RM		
			18: STF+RH		
19: STR+RH					

Group	Parameter Number	Name	Setting Range	Default	Page
03-00	P.83	Terminal STF input function	20: STF+RL+RM	0	119
			21: STR+RL+RM		
			22: STF+RT+RL		
			23: STR+RT+RL		
			24: STF+RT+RM		
			25: STR+RT+RM		
			26: STF+RT+RL+RM		
			27: STR+RT+RL+RM		
			28: RUN(Inverter runs forward)		
			29: STF/STR(use with RUN signal, when ON, motor runs reverse ; when OFF, motor runs forward)		
			30: RES(External reset function)		
			31: STOP(Use as three line control with RUN signal and STF-STR signal)		
			32: REX(Extend multi-speed to 16 levels)		
			33: PO(In "external mode", run programmed operation)		
			34: RES_E (External reset, valid only when alarm.)		
			35: MPO (In "external mode" run manual cycle operation.)		
			36: TRI(Triangle wave function)		
			37: GP_BP (Automatic switch between inverter and commercial power-supply.)		
			38: CS(Manual switch to commercial power supply)		
			39: STF/STR +STOP (Use with RUN signal, when ON, motor runs reverse, when OFF, motor stops then runs forward.)		
			40: P_MRS (Stops inverter output immediately by pulse signal input)		
			41: PWM set frequency(Note 1)		
			42: MTCLKA/MTCLKB(only for M0/M1 )		
			43: RUN_EN (Enable digital input terminal operation)		
			44: PID_OFF (Enable digital input terminal turning off PID)		
			45: Second mode		
			46: Initial roll radius selection 1		
			47: Initial roll radius selection 2		
			48: Thickness selection 1		
			49: Thickness selection 2		
			50: Winding unwinding switch		
			51: Predrive command		
			52: Save torque value		
			53: Save torque value enable		
			54: Revs counting signal (note1)		
			55: Speed/Torque control switch		
			56: Roll radius reset		
			57: High-speed pulse input function (note1)		
			58: Analog terminal 2-5 high priority		
			60: Built-in PLC start/stop		
			61: SHOM (Homing enable)		
			62: ORGP (Set homing point)		

Appendix 1 Parameter table

Group	Parameter Number	Name	Setting Range	Default	Page
03-00	P.83	Terminal STF input function	63: Position/Speed control switch	0	<u>119</u>
			64: External zero-servo switch		
			65: External accelerate/decelerate pause		
			66: External forced stop		
			67 : Roll diameter calculation stop		
			68 : Enable single point positioning		
			69 : Enable multipoint positioning		
			70 : Enable entire position control by pulse input command		
			71 : External torque command polarity reverse		
			99999 : Off		
03-01	P.84	Terminal STR input function	Same as 03-00(P.83)	1	<u>120</u>
03-02	P.86	Terminal RES input function	Same as 03-00(P.83)	30	<u>120</u>
03-03	P.80	Terminal M0 input function	Same as 03-00(P.83)	2	<u>121</u>
03-04	P.81	Terminal M1 input function	Same as 03-00(P.83)	3	<u>121</u>
03-05	P.82	Terminal M2 input function	Same as 03-00(P.83)	4	<u>121</u>
03-10	P.40	Terminal SO-SE output function	0: RUN(Output when inverter running)	1	<u>126</u>
			1: SU(Output when reach target frequency)		
			2: FU(Output when reach 03-21 03-22 value )		
			3: OL(Output when overload)		
			4: OMD(Output when output current is zero)		
			5: ALARM(Output when alarm)		
			6: PO1(Output when in program operation step)		
			7: PO2(Output when in program operation cycle)		
			8:PO3(Output when in program operation pause)		
			9: BP(Output when use inverter output in function : switch between inverter and commercial power-supply)		
			10: GP(Output when use commercial power-supply in function : switch between inverter and commercial power-supply)		
			11 : OMD1(Output when output current is zero 1)		
			12 ~ 16: Reserved		
			17: RY(Output when inverter is powered on and no alarm)		
			18: Output when it's time for maintenance		
			19: OL2 (Output when overload 2)		
			20: Output when capacitor abnormal		
			21:Output when in position control reach position		
			22 : Output when detect curl in tension control		
23 : Output when detect power marker					
24 ~ 40: Reserved					
41: Feedback disconnection alarm					



Group	Parameter Number	Name	Setting Range	Default	Page
03-11	P.85	Terminal A-B-C output function	Same as 03-10(P.40)	5	<a href="#">126</a>
03-14	P.87	Digital input logic	0 ~ 1023	0	<a href="#">127</a>
03-15	P.88	Digital output logic (with expansion card)	0 ~ 4095	0	<a href="#">127</a>
03-16	P.120	Output signal delay time	0 ~ 3600.0s	0.0s	<a href="#">128</a>
03-17	P.157	Digital input terminal filter time	0 ~ 2000ms	8ms	<a href="#">128</a>
03-18	P.158	Digital input terminal enable when power on	0: When power on digital terminals work directly	0	<a href="#">128</a>
			1:When power on digital terminals work after switch off then on		
03-20	P.41	Output frequency detection sensitivity	0 ~ 100.0%	10.0%	<a href="#">129</a>
03-21	P.42	Output frequency detection for forward rotation	0 ~ 650.00Hz	6.00Hz	<a href="#">129</a>
03-22	P.43	Output frequency detection for reverse rotation	0 ~ 650.00Hz	99999	<a href="#">129</a>
			99999: Same as the setting of 03-21(P.42)		
03-23	P.62	Zero current detection level	0 ~ 200.0%	5.0%	<a href="#">130</a>
			99999: Off		
03-24	P.63	Zero current detection time	0 ~ 100.00s	0.50s	<a href="#">130</a>
			99999: Off		
03-25	P.551	Expanded digital input terminal M10	Same as 03-00(P.83)	99999	<a href="#">130</a>
03-26	P.552	Expanded digital input terminal M11	Same as 03-00(P.83)	99999	<a href="#">130</a>
03-27	P.553	Expanded digital input terminal M12	Same as 03-00(P.83)	99999	<a href="#">130</a>
03-28	P.554	Expanded digital input terminal M13	Same as 03-00(P.83)	99999	<a href="#">130</a>
03-29	P.555	Expanded digital input terminal M14	Same as 03-00(P.83)	99999	<a href="#">130</a>
03-30	P.556	Expanded digital input terminal M15	Same as 03-00(P.83)	99999	<a href="#">130</a>
03-41	P.567	Expanded digital input terminal logic (Slot2&3)	0 ~ 63	0	<a href="#">131</a>
03-42	P.568	Expanded digital output terminal A10	Same as 03-10(P.40)	99999	<a href="#">131</a>
03-43	P.569	Expanded digital output terminal A11	Same as 03-10(P.40)	99999	<a href="#">131</a>
03-44	P.570	Expanded digital output terminal A12	Same as 03-10(P.40)	99999	<a href="#">131</a>
03-45	P.571	Expanded digital output terminal A13	Same as 03-10(P.40)	99999	<a href="#">131</a>
03-46	P.572	Expanded digital output terminal A14	Same as 03-10(P.40)	99999	<a href="#">131</a>
03-47	P.573	Expanded digital output terminal A15	Same as 03-10(P.40)	99999	<a href="#">131</a>
03-48	P.574	Expanded digital output terminal A16	Same as 03-10(P.40)	99999	<a href="#">131</a>
03-49	P.575	Expanded digital output terminal A17	Same as 03-10(P.40)	99999	<a href="#">131</a>
03-59	P.585	Monitor inverter digital input terminal state	Read only	Read	<a href="#">132</a>
03-60	P.586	Monitor inverter and expanded digital output terminal state	Read only	Read	<a href="#">132</a>
03-61	P.587	Monitor expanded digital input terminal state	Read only	Read	<a href="#">132</a>
04-00	P.4	Speed1(high speed)	0 ~ 650.00Hz	60.00Hz	<a href="#">135</a>

Appendix 1 Parameter table

Group	Parameter Number	Name	Setting Range	Default	Page
04-01	P.5	Speed2(mediumspeed)	0 ~ 650.00Hz	30.00Hz	<a href="#">135</a>
04-02	P.6	Speed3(low speed)	0 ~ 650.00Hz	10.00Hz	<a href="#">135</a>
04-03	P.24	Speed4	0 ~ 650.00Hz	99999	<a href="#">135</a>
			99999: Function invalid		
04-04	P.25	Speed5	Same as 04-03(P.24)	99999	<a href="#">135</a>
04-05	P.26	Speed6	Same as 04-03(P.24)	99999	<a href="#">135</a>
04-06	P.27	Speed7	Same as 04-03(P.24)	99999	<a href="#">135</a>
04-07	P.142	Speed8	Same as 04-03(P.24)	99999	<a href="#">135</a>
04-08	P.143	Speed9	Same as 04-03(P.24)	99999	<a href="#">135</a>
04-09	P.144	Speed10	Same as 04-03(P.24)	99999	<a href="#">135</a>
04-10	P.145	Speed11	Same as 04-03(P.24)	99999	<a href="#">135</a>
04-11	P.146	Speed12	Same as 04-03(P.24)	99999	<a href="#">135</a>
04-12	P.147	Speed13	Same as 04-03(P.24)	99999	<a href="#">135</a>
04-13	P.148	Speed14	Same as 04-03(P.24)	99999	<a href="#">135</a>
04-14	P.149	Speed15	Same as 04-03(P.24)	99999	<a href="#">135</a>
04-15	P.100	Programmed operation minute / second selection	0: Select minute as the time increment.	1	<a href="#">137</a>
			1: Select second as the time increment.		
04-16	P.121	Run direction in each section	0 ~ 255	0	<a href="#">137</a>
04-17	P.122	Programmed operation cycle selection	0:Off	0	<a href="#">137</a>
			1 ~ 8: Start cycle from the set section.		
04-18	P.123	Programmed operation acceleration / deceleration time setting selection	0: Acceleration time is 01-06(P.7), deceleration time is 01-07(P.8).	0	<a href="#">137</a>
			1: Acceleration and deceleration time is set by 04-35(P.111) ~ 04-42(P.118).		
04-19	P.131	Programmed operation mode speed 1	0 ~ 650.00Hz	0.00 Hz	<a href="#">137</a>
04-20	P.132	Programmed operation mode speed 2	0 ~ 650.00Hz	0.00 Hz	<a href="#">137</a>
04-21	P.133	Programmed operation mode speed 3	0 ~ 650.00Hz	0.00 Hz	<a href="#">137</a>
04-22	P.134	Programmed operation mode speed 4	0 ~ 650.00Hz	0.00 Hz	<a href="#">137</a>
04-23	P.135	Programmed operation mode speed 5	0 ~ 650.00Hz	0.00 Hz	<a href="#">137</a>
04-24	P.136	Programmed operation mode speed 6	0 ~ 650.00Hz	0.00 Hz	<a href="#">137</a>
04-25	P.137	Programmed operation mode speed 7	0 ~ 650.00Hz	0.00 Hz	<a href="#">137</a>
04-26	P.138	Programmed operation mode speed 8	0 ~ 650.00Hz	0.00 Hz	<a href="#">137</a>
04-27	P.101	Programmed operation mode speed 1 operating time	0 ~ 6000.0s	0.0s	<a href="#">137</a>
04-28	P.102	Programmed operation mode speed 2 operating time	0 ~ 6000.0s	0.0s	<a href="#">137</a>
04-29	P.103	Programmed operation mode speed 3 operating time	0 ~ 6000.0s	0.0s	<a href="#">137</a>
04-30	P.104	Programmed operation mode speed 4 operating time	0 ~ 6000.0s	0.0s	<a href="#">137</a>

Group	Parameter Number	Name	Setting Range	Default	Page
04-31	P.105	Programmed operation mode speed 5 operating time	0 ~ 6000.0s	0.0s	<a href="#">137</a>
04-32	P.106	Programmed operation mode speed 6 operating time	0 ~ 6000.0s	0.0s	<a href="#">137</a>
04-33	P.107	Programmed operation mode speed 7 operating time	0 ~ 6000.0s	0.0s	<a href="#">137</a>
04-34	P.108	Programmed operation mode speed 8 operating time	0 ~ 6000.0s	0.0s	<a href="#">137</a>
04-35	P.111	Programmed operation mode speed 1 Acc/Dec time	0 ~ 600.00s/0 ~ 6000.0s	0.00s	<a href="#">137</a>
04-36	P.112	Programmed operation mode speed 2 Acc/Dec time	0 ~ 600.00s/0 ~ 6000.0s	0.00s	<a href="#">137</a>
04-37	P.113	Programmed operation mode speed 3 Acc/Dec time	0 ~ 600.00s/0 ~ 6000.0s	0.00s	<a href="#">138</a>
04-38	P.114	Programmed operation mode speed 4 Acc/Dec time	0 ~ 600.00s/0 ~ 6000.0s	0.00s	<a href="#">138</a>
04-39	P.115	Programmed operation mode speed 5 Acc/Dec time	0 ~ 600.00s/0 ~ 6000.0s	0.00s	<a href="#">138</a>
04-40	P.116	Programmed operation mode speed 6 Acc/Dec time	0 ~ 600.00s/0 ~ 6000.0s	0.00s	<a href="#">138</a>
04-41	P.117	Programmed operation mode speed 7 Acc/Dec time	0 ~ 600.00s/0 ~ 6000.0s	0.00s	<a href="#">138</a>
04-42	P.118	Programmed operation mode speed 8 Acc/Dec time	0 ~ 600.00s/0 ~ 6000.0s	0.00s	<a href="#">138</a>
05-00	P.301	Motor specifications automatic measurement	0: Off	0	<a href="#">142</a>
			1: Induction motor specifications automatic measurement 1 (Run motor to measure)		
			2: Induction motor specifications automatic measurement 2 (Don't run motor to measure)		
			3: Induction motor specifications automatic measurement (Measure when operating)		
			4:Reserved		
			5 : Induction motor specifications automatic measurement 3 (Don't run motor to measure)		
			8: Synchronous motor specifications automatic measurement (Run motor to measure)		
			9: Synchronous motor phase Z position automatic measurement (Run motor to measure)		
			10: Synchronous motor rotation inertia automatic measurement (Run motor to measure)		
05-01	P.302	Motor rated power	0 ~ 650.00kW	0.00kW	<a href="#">145</a>
05-02	P.303	Motor poles	0 ~ 256	4	<a href="#">145</a>
05-03	P.304	Motor rated voltage	440 Voltage : 0 ~ 510V	According to voltage	<a href="#">145</a>
			220 Voltage : 0~255V		

Appendix 1 Parameter table

Group	Parameter Number	Name	Setting Range	Default	Page
05-04	P.305	Motor rated frequency	50Hz system: 0 ~ 650.00Hz	50.00Hz	<a href="#">145</a>
			60Hz system: 0 ~ 650.00Hz	60.00Hz	
05-05	P.306	Motor rated current	0~500.00A	According to kW	<a href="#">145</a>
05-06	P.307	Motor rated rotation speed	50Hz system: 0 ~ 65000r/min	1410r/min	<a href="#">145</a>
			60Hz system: 0 ~ 65000r/min	1710r/min	
05-07	P.308	Motor excitation current	0~500.00A	According to kW	<a href="#">145</a>
05-08	P.309	IM motor stator resistance	0 ~ 65000mΩ	According to kW	<a href="#">145</a>
05-09	P.310	IM motor rotor resistance	0 ~ 65000mΩ	According to kW	<a href="#">145</a>
05-10	P.311	IM motor leakage inductance	0 ~ 6500.0mH	According to kW	<a href="#">145</a>
05-11	P.312	IM motor mutual inductance	0 ~ 6500.0mH	According to kW	<a href="#">145</a>
05-12	P.313	PM motor stator resistance	0 ~ 65000mΩ	According to kW	<a href="#">145</a>
05-13	P.314	PM motor d-axis inductance	0 ~ 650.00mH	According to kW	<a href="#">145</a>
05-14	P.315	PM motor q-axis inductance	0 ~ 650.00mH	According to kW	<a href="#">145</a>
05-15	P.316	PM motor Back-EMF coefficient	0 ~ 6500.0V/krpm	According to kW	<a href="#">145</a>
05-16	P.317	PM motor Phase Z origin pulse compensation	0 ~ 359.9°	0.0°	<a href="#">145</a>
05-17	P.318	Motor inertia	0 ~ 6500.0kg. cm2: 5.5K and below	According to kW	<a href="#">147</a>
			0 ~ 65000kg.cm2: 7.5K~ 22kW		
05-18	P.319	Load inertia ratio	0~600.0	1.0	<a href="#">147</a>
05-19	P.391	Inertia identification speed limit	0~100%	50%	<a href="#">147</a>
05-20	P.392	Acceleration and deceleration time of inertia identification	0 ~ 20.0s	2.0s	<a href="#">147</a>
05-21	P.393	Operation mode of inertia identification	0: one direction rotation	1	<a href="#">147</a>
			1: both direction rotation		
05-22	P.332	Second motor rated power	0 ~ 650.00kW	99999	<a href="#">148</a>
			99999		
05-23	P.333	Second motor poles	0 ~ 256	99999	<a href="#">148</a>
			99999		
05-24	P.334	Second motor rated voltage	440 Voltage : 0 ~ 510V	99999	<a href="#">148</a>
			220 Voltage : 0~255V		
			99999		
05-25	P.335	Second motor rated frequency	0 ~ 650.00Hz	99999	<a href="#">148</a>
			99999		
05-26	P.336	Second motor rated current	0~500.00A	99999	<a href="#">148</a>
			99999		
05-27	P.337	Second motor rated rotation speed	0 ~ 65000r/min	99999	<a href="#">148</a>
			99999		

Group	Parameter Number	Name	Setting Range	Default	Page
05-28	P.338	Second motor excitation current	0~500.00A 99999	99999	<u>148</u>
05-29	P.339	Second motor (IM)stator resistance	0 ~ 65000mΩ 99999	99999	<u>148</u>
05-30	P.340	Second motor (IM)rotor resistance	0 ~ 65000mΩ 99999	99999	<u>148</u>
05-31	P.341	Second motor (IM)leakage inductance	0 ~ 6500.0mH 99999	99999	<u>148</u>
05-32	P.342	Second motor (IM)mutual inductance	0 ~ 6500.0mH 99999	99999	<u>148</u>
05-33	P.343	Second motor (PM) stator resistance	0 ~ 65000mΩ 99999	99999	<u>148</u>
05-34	P.344	Second motor (PM) d-axis inductance	0 ~ 650.00mH 99999	99999	<u>148</u>
05-35	P.345	Second motor (PM)q-axis inductance	0 ~ 650.00mH 99999	99999	<u>148</u>
05-36	P.346	Second motor (PM) Back-EMF coefficient	0 ~ 6500.0V/krpm 99999	99999	<u>149</u>
05-37	P.347	Second motor (PM) Phase Z origin pulse compensation	0 ~ 359.9° 99999	99999	<u>149</u>
05-38	P.394	Second motor inertia	0 ~ 6500.0kg. cm2: 5.5k and below 0 ~ 65000kg. cm2: 7.5k ~ 22K model 99999	99999	<u>149</u>
05-39	P.395	Second motor load inertia ratio	0~600.0 99999	99999	<u>149</u>
06-00	P.9	Electronic thermal relay capacity	0~500.00A	0.00A	<u>153</u>
06-01	P.22	Stall prevention operation level	0 ~ 250.0%	150.0%	<u>154</u>
06-02	P.23	Stall prevention operation level correction factor	0 ~ 150.0% 99999: Stall prevention operation level is the setting value of 06-01(P.22).	99999	<u>154</u>
06-03	P.66	Stall prevention operation reduction starting frequency	50Hz system: 0 ~ 650.00Hz 60Hz system: 0 ~ 650.00Hz	50.00Hz 60.00Hz	<u>154</u>
06-04	P.220	Acceleration and deceleration time when current stall	X0: According to the current Acc/Dec time X1: According to the first Acc/Dec time X2: According to the second Acc/Dec time X3: Automatically calculate proper Acc/Dec time 0X: Current stall frequency reduction is invalid during acceleration/constant speed/deceleration 1X: Current stall frequency reduction is valid during constant speed 2X: Current stall frequency reduction is valid during acceleration	33	<u>154</u>

Appendix 1 Parameter table

Group	Parameter Number	Name	Setting Range	Default	Page
06-04	P.220	Acceleration and deceleration time when current stall	3X: Current stall frequency reduction is valid during acceleration and constant speed	33	154
			4X: Current stall frequency reduction is valid during deceleration		
			5X: Current stall frequency reduction is valid during deceleration and constant speed		
			6X: Current stall frequency reduction is valid during acceleration and deceleration		
			7X: Current stall frequency reduction is valid during acceleration/constant speed/deceleration		
06-05	P.30	Regenerative brake selection	0: Brake duty is fixed at 3%, parameter 06-06(P.70) will be off. 1: Brake duty is 06-06(P.70) value.	0	156
06-06	P.70	Special regenerative brake duty	0 ~ 100.0%	0.0%	156
06-07	P.263	Decrease carrier protection setting	0: Fixed carrier frequency, and limit output current according to carrier value.	0	156
			1: Fixed rated current, and limit carrier according to output current and temperature.		
06-08	P.155	Over torque detection level	0 ~ 200.0%	0.0%	158
06-09	P.156	Over torque detection time	0.1 ~ 60.0s	1.0s	158
06-10	P.260	Action when detect over torque	0: OL2 alarm will not be reported after over torque detection, and inverter keeps running.	1	158
			1: OL2 alarm will be reported after over torque detection, and inverter stops.		
06-11	P.160	Stall level when restart	0 ~ 150.0%	100.0%	159
06-12	P.245	Cooling fan operation	0: Fan turn on when inverter starts running. Fan turn off 30 seconds after inverter stops.	0	159
			1: Fan turn on when inverter power on. Fan turn off when inverter power off.		
			2: Fan turn on if heat sink temperature is higher than 40°C. Fan turn off when inverter power off		
			3: Fan turn on if heat sink temperature is higher than 60°C. Fan turn off when heat sink temperature is lower than 40°C.		
06-13	P.281	Input phase loss protection	0: Off	0	160
			1: When input phase loss, inverter stops and alarms IPF.(For Frame C/D only)		
06-14	P.287	SCP Short circuit protection function	0: Off	1	160
			1: When output side is short, inverter stops and alarms SCP.		
06-15	P.533	PTC alarm action	0: Alarm and continue to run	0	160
			1: Alarm and decelerate to stop		
			2: Alarm and stop freely		
			3: No alarm		

Group	Parameter Number	Name	Setting Range	Default	Page
06-16	P.534	Percentage of PTC level	0 ~ 100.0%	0.0%	<a href="#">160</a>
06-17	P.261	Maintenance alarm function	0: Off	0	<a href="#">161</a>
			1 ~ 9998day: Used to set the time for maintenance alarm output signal		
06-18	P.280	Short circuit to ground detection when starting	X0:When given run command to inverter, inverter does not detect short circuit to ground	10	<a href="#">161</a>
			X1:When given run command to inverter, inverter detects short circuit to ground		
			0X:When given run command to inverter, inverter does not detect short circuit between phase		
			1X:When given run command to inverter, inverter detects short circuit between phase		
06-19	P.282	GF detection level when running	0~100.0%	50.0%	<a href="#">161</a>
06-20	P.262	Output phase loss protection	0: Off	0	<a href="#">162</a>
			1: When output phase loss, inverter stops and alarms LF.		
06-21	P.705	Low voltage level	155 ~ 220V: 220V inverter type	155V	<a href="#">162</a>
			310 ~ 440V: 440V inverter type	310V	
06-22	P.706	Regenerative brake operation level	205 ~ 400V: 220V inverter type	360V	<a href="#">162</a>
			410 ~ 800V: 440V inverter type	720V	
06-23	P.707	Voltage stall level	205 ~ 400V: 220V inverter type	380V	<a href="#">163</a>
			410 ~ 800V: 440V inverter type	760V	
06-24	P.708	Capacitor lifetime detection	0: Off	0	<a href="#">163</a>
			1: When the power is OFF, start to detect the lifetime of capacitor on main circuit.		
06-25	P.709	Capacitor lifetime detection level	0 ~ 100.0%	100.0%	<a href="#">163</a>
06-26	P.710	Capacitor lifetime detection result	0: Normal.	Read	<a href="#">163</a>
			1: Electrolytic capacitor abnormal.		
06-27	P.292	Total inverter operation time (minutes)	0 ~ 1439 min	0min	<a href="#">164</a>
06-28	P.293	Total inverter operation time (days)	0 ~ 9999 day	0day	<a href="#">164</a>
06-29	P.296	Total inverter power on time (minutes)	0 ~ 1439min	0min	<a href="#">164</a>
06-30	P.297	Total inverter power on time (days)	0 ~ 9999 day	0day	<a href="#">164</a>
06-31	P.298	Output power(lower 16 bit)	Read only	Read	<a href="#">164</a>
06-32	P.299	Output power(higher 16 bit)	Read only	Read	<a href="#">164</a>
06-40	P.288	Alarm record code query	0 ~ 12	1	<a href="#">165</a>
06-41	P.289	Alarm record code display	Read only	Read	<a href="#">165</a>

Appendix 1 Parameter table

Group	Parameter Number	Name	Setting Range	Default	Page
06-42	P.290	Alarm record message query	0 ~ 10	0	<a href="#">165</a>
06-43	P.291	Alarm record message display	Read only	Read	<a href="#">165</a>
06-44	P.740	E1	Read only	Read	<a href="#">166</a>
06-45	P.741	E2	Read only	Read	<a href="#">166</a>
06-46	P.742	E3	Read only	Read	<a href="#">166</a>
06-47	P.743	E4	Read only	Read	<a href="#">166</a>
06-48	P.744	E5	Read only	Read	<a href="#">166</a>
06-49	P.745	E6	Read only	Read	<a href="#">166</a>
06-50	P.746	E7	Read only	Read	<a href="#">166</a>
06-51	P.747	E8	Read only	Read	<a href="#">166</a>
06-52	P.748	E9	Read only	Read	<a href="#">166</a>
06-53	P.749	E10	Read only	Read	<a href="#">166</a>
06-54	P.750	E11	Read only	Read	<a href="#">166</a>
06-55	P.751	E12	Read only	Read	<a href="#">166</a>
06-56	P.752	Output frequency during E1 alarm	Read only	Read	<a href="#">167</a>
06-57	P.753	Output current during E1 alarm	Read only	Read	<a href="#">167</a>
06-58	P.754	Output voltage during E1 alarm	Read only	Read	<a href="#">167</a>
06-59	P.755	Temperature rising accumulation rate during E1 alarm	Read only	Read	<a href="#">167</a>
06-60	P.756	PN voltage during E1 alarm	Read only	Read	<a href="#">167</a>
06-61	P.757	Total inverter operation time during E1 alarm	Read only	Read	<a href="#">167</a>
06-62	P.758	Inverter operation status code during E1 alarm	Read only	Read	<a href="#">167</a>
06-63	P.759	E1 alarm date (years / months)	Read only	Read	<a href="#">167</a>
06-64	P.760	E1 alarm date (days/hours)	Read only	Read	<a href="#">167</a>
06-65	P.761	E1 alarm date (minutes / seconds)	Read only	Read	<a href="#">167</a>
06-70	P.766	Output frequency during E2 alarm	Read only	Read	<a href="#">167</a>
06-71	P.767	Output current during E2 alarm	Read only	Read	<a href="#">167</a>
06-72	P.768	Output voltage during E2 alarm	Read only	Read	<a href="#">167</a>
06-73	P.769	Temperature rising accumulation rate during E2 alarm	Read only	Read	<a href="#">167</a>
06-74	P.770	PN voltage during E2 alarm	Read only	Read	<a href="#">167</a>
06-75	P.771	Total inverter operation time during E2 alarm	Read only	Read	<a href="#">167</a>
06-76	P.772	Inverter operation status code during E2 alarm	Read only	Read	<a href="#">167</a>
06-77	P.773	E2 alarm date (years / months)	Read only	Read	<a href="#">167</a>
06-78	P.774	E2 alarm date (days/hours)	Read only	Read	<a href="#">167</a>
06-79	P.775	E2 alarm date (minutes / seconds)	Read only	Read	<a href="#">167</a>
07-00	P.33	COM1 Communication protocol selection	0: Modbus protocol	1	<a href="#">171</a>
			1: Shihlin protocol		
			2 : PLC protocol ( Effective when using Shihlin built-in PLC )		



Group	Parameter Number	Name	Setting Range	Default	Page
07-01	P.36	COM1 inverter communication station number	0 ~ 254	0	<a href="#">171</a>
07-02	P.32	COM1 Serial communication baud rate	0: Baud rate:4800bps	1	<a href="#">171</a>
			1: Baud rate:9600bps		
			2: Baud rate:19200bps		
			3: Baud rate:38400bps		
			4: Baud rate:57600bps		
07-03	P.48	COM1 data length	0: 8bit 1: 7bit	0	<a href="#">171</a>
07-04	P.49	COM1 stop bit length	0: 1bit 1: 2bit	0	<a href="#">171</a>
07-05	P.50	COM1 parity check selection	0: No parity check	0	<a href="#">171</a>
			1: Odd		
			2: Even		
07-06	P.51	COM1 CR/LF selection	1: CR only	1	<a href="#">171</a>
			2: Both CR and LF		
07-07	P.154	COM1 Modbus communication format	0: 1, 7, N, 2 (Modbus, ASCII)	4	<a href="#">171</a>
			1: 1, 7, E, 1 (Modbus, ASCII)		
			2: 1, 7, O, 1 (Modbus, ASCII)		
			3: 1, 8, N, 2 (Modbus, RTU)		
			4: 1, 8, E, 1 (Modbus, RTU)		
07-08	P.52	COM1 Number of communication retries	0 ~ 10	1	<a href="#">171</a>
07-09	P.53	COM1 communication interval allowed time	0~999.8s: Checking communication timeout with the set value	99999	<a href="#">171</a>
			99999: No timeout check		
07-10	P.153	COM1 communication alarm action	0: Alarm and stop freely	1	<a href="#">171</a>
			1: No alarm and continuing to operation		
07-11	P.34	Communication EEPROM write-in selection	0: When writing parameters in communication mode, write in RAM and EEPROM	0	<a href="#">187</a>
			1: When writing parameters through communication, only write into RAM		
07-15	P.800	CANopen slave address	0 ~ 127	0	<a href="#">188</a>
07-16	P.801	CANopen rate	0: 1Mbps	0	<a href="#">188</a>
			1: 500Kbps		
			2: 250K/280Kbps		
			3: 125Kbps		
			4: 100Kbps		
5: 50 Kbps					

Appendix 1 Parameter table

Group	Parameter Number	Name	Setting Range	Default	Page
07-17	P.802	CANopen communication status	0: Node retry status	0	<a href="#">188</a>
			1: Communication retry status		
			2: Retry completion status		
			4: stop state		
			5: operation status		
			127: pre-operational status		
07-18	P.803	CANopen control status	0: Boot not completed status	0	<a href="#">188</a>
			1: Forbidden operation state		
			2: Pre-excitation status		
			3: Excitation state		
			4: Allowed operating status		
			7: Quick action stop status		
			13: Trigger error action status		
			14: Error status		
07-25	P.810	PU communication protocol selection	0: Modbus protocol	1	<a href="#">171</a>
			1: Shihlin protocol		
			2: PLC protocol (Effective when using Shihlin built-in PLC)		
07-26	P.811	PU inverter communication station number	0~254	0	<a href="#">171</a>
07-27	P.812	PU Serial communication baud rate	0 : Baud rate 4800bps	1	<a href="#">172</a>
			1 : Baud rate 9600bps		
			2 : Baud rate 19200bps		
			3 : Baud rate 38400bps		
			4 : Baud rate 57600bps		
			5 : Baud rate 115200bps		
07-28	P.813	PU data length	0 : 8bit	0	<a href="#">172</a>
			1 : 7bit		
07-29	P.814	PU stop bit	0 : 1bit	0	<a href="#">172</a>
			1 : 2bit		
07-30	P.815	PU Parity check option	0 : no parity check	0	<a href="#">172</a>
			1 : odd check		
			2 : even check		
07-31	P.816	PU CR/LF selection	1: CR only	1	<a href="#">172</a>
			2: Both CR and LF		
07-32	P.817	PU Modbus communication format	0 : 1, 7, N, 2 (Modbus, ASCII)	4	<a href="#">172</a>
			1 : 1, 7, E, 1 (Modbus, ASCII)		
			2 : 1, 7, O, 1 (Modbus, ASCII)		
			3 : 1, 8, N, 2 (Modbus, RTU)		
			4 : 1, 8, E, 1 (Modbus, RTU)		
			5 : 1, 8, O, 1 (Modbus, RTU)		
07-33	P.818	PU Number of communication retries	0 ~ 10	1	<a href="#">172</a>
07-34	P.819	PU communication interval allowed time	0~999.8s: Check communication timeout with the set value	99999	<a href="#">172</a>
			99999: Off		

Group	Parameter Number	Name	Setting Range	Default	Page
07-35	P.820	PU communication error handling	0: Alarm and stop freely.	1	<a href="#">172</a>
			1: No alarm and continue running		
07-41	P.826	Expansion communication card number of communication retries	0~10	1	<a href="#">172</a>
07-42	P.827	Expansion communication card communication error handling	0: Alarm and idling and stopping	1	<a href="#">172</a>
			1: No alarm and continue running		
07-43	P.828	Expansion communication card communication interval allowed time	0~999.8s: Check communication timeout with the set value	99999	<a href="#">172</a>
			99999: Off		
07-44	P.829	Version of EP301 communication card	Read only	read	<a href="#">188</a>
07-45	P.830	IP configuration	0: Static IP	0	<a href="#">189</a>
			1: Dynamic IP		
07-46	P.831	IP address 1	0~255	192	<a href="#">189</a>
07-47	P.832	IP address 2	0~255	168	<a href="#">189</a>
07-48	P.833	IP address 3	0~255	2	<a href="#">189</a>
07-49	P.834	IP address 4	0~255	102	<a href="#">189</a>
07-50	P.835	Subnet mask 1	0~255	255	<a href="#">189</a>
07-51	P.836	Subnet mask 2	0~255	255	<a href="#">189</a>
07-52	P.837	Subnet mask 3	0~255	255	<a href="#">189</a>
07-53	P.838	Subnet mask 4	0~255	0	<a href="#">189</a>
07-54	P.839	Default gateway 1	0~255	192	<a href="#">189</a>
07-55	P.840	Default gateway 2	0~255	168	<a href="#">189</a>
07-56	P.841	Default gateway 3	0~255	2	<a href="#">189</a>
07-57	P.842	Default gateway 4	0~255	100	<a href="#">189</a>
08-00	P.170	PID function selection	0: Off	0	<a href="#">192</a>
			0X: Parameter 08-03(P.225) as target value.		
			1X: Terminal 2-5 input as target source		
			2X: Terminal 4-5 input as target source		
			3X: Reserved		
			4X: Terminal M2 input as target source		
			X1: Terminal 2-5 input as feedback source		
			X2: Terminal 4-5 input as feedback source		
X3:Reserved					
08-01	P.171	PID feedback control method	0: Negative feedback control.	0	<a href="#">192</a>
			1: Positive feedback control.		
08-02	P.241	PID sampling period	0 ~ 60000 ms	20ms	<a href="#">192</a>
08-03	P.225	PID target value panel reference	0 ~ 08-43(P.251)	20.0%	<a href="#">192</a>
08-04	P.172	Proportional gain	0.1% ~ 1000.0%	20.0%	<a href="#">192</a>
08-05	P.173	Integral time	0 ~ 60.00s	1.00s	<a href="#">192</a>
08-06	P.174	Differential time	0 ~ 10000ms	0ms	<a href="#">193</a>
08-07	P.175	Abnormal deviation	0 ~ 100.0%	0.0%	<a href="#">193</a>
08-08	P.176	Abnormal duration time	0~600.0s	30.0s	<a href="#">193</a>
08-09	P.177	Abnormal processing mode	0: Stop freely	0	<a href="#">193</a>
			1: Slow down to stop		
			2: Alarm and continue operation		

Appendix 1 Parameter table

Group	Parameter Number	Name	Setting Range	Default	Page
08-10	P.178	Sleep detection deviation	0 ~ 100.0%	0.0%	<a href="#">193</a>
08-11	P.179	Sleep detection duration time	0 ~ 255.0s	1.0s	<a href="#">193</a>
08-12	P.180	Wake-up level	0 ~ 100.0%	90.0%	<a href="#">193</a>
08-13	P.181	Stop level	0 ~ 120.00Hz	40.00Hz	<a href="#">193</a>
08-14	P.182	Upper integral limit	0 ~ 200.0%	100.0%	<a href="#">193</a>
08-15	P.183	Deceleration step length when stable	0 ~ 10.00Hz	0.50Hz	<a href="#">193</a>
08-20	P.641	Proportional gain P2	0.1% ~ 1000.0%	20.0%	<a href="#">197</a>
08-21	P.642	Integral time I2	0 ~ 60.00s	1.00s	<a href="#">197</a>
08-22	P.643	Differential time D2	0 ~ 10000ms	0ms	<a href="#">197</a>
08-23	P.644	Auto adjustment for PID parameters	0: Adjust according to the feedback deviation value	0	<a href="#">197</a>
			1: Adjust according to the curling radius.		
			2: Adjust according to the operation frequency		
			3: Adjust according to the line speed		
08-24	P.711	PID target signal filter time	0 ~ 650.00s	0.00s	<a href="#">198</a>
08-25	P.712	PID feedback signal filter time	0 ~ 60.00s	0.00s	<a href="#">198</a>
08-26	P.713	PID output signal filter time	0 ~ 60.00s	0.00s	<a href="#">198</a>
08-27	P.714	PID deviation control limit	0 ~ 100.00%	0.00%	<a href="#">198</a>
08-28	P.715	Integral separated property	0: Off	0	<a href="#">199</a>
			1: Integral separated		
08-29	P.716	Integral separated point	0 ~ 100.00%	50.00%	<a href="#">199</a>
08-30	P.717	PID differential limit	0 ~ 100.00%	0.10%	<a href="#">199</a>
08-31	P.718	PID output positive deviation limit	0 ~ 100.00%	100.0%	<a href="#">199</a>
08-32	P.719	PID output negative deviation limit	0 ~ 100.00%	100.0%	<a href="#">199</a>
08-33	P.720	PID parameter switchover operation selection	0: No PID parameter switchover.	0	<a href="#">200</a>
			1: PID parameter switchover based on deviation.		
08-34	P.721	PID parameter switchover deviation lower limit	0 ~ 100.00%	20.00%	<a href="#">200</a>
08-35	P.722	PID parameter switchover deviation upper limit	0 ~ 100.00%	80.00%	<a href="#">200</a>
08-36	P.723	PID disconnection operation option 1	0: Select no need to run to the upper limit when PID is disconnected	1	<a href="#">200</a>
			1: Select need to run to the upper limit when PID is disconnected		
08-39	P.726	PID counting when inverter stop action selection	0: PID stop counting when inverter stop	0	<a href="#">200</a>
			1: PID keep counting when inverter stop		
08-40	P.727	PID allowed reverse rotation action selection	0: PID does not allow reverse rotation	0	<a href="#">201</a>
			1: PID allows reverse rotation		
08-41	P.728	PID in reverse direction integral limit	0 ~ 100.0%	0.0%	<a href="#">201</a>

Group	Parameter Number	Name	Setting Range	Default	Page
08-42	P.729	PID minimum output frequency	0 ~ 10.00Hz	0.00Hz	<a href="#">201</a>
08-43	P.251	Pressure unit (Bar) setting	1.0~100.0	100.0	<a href="#">201</a>
08-45	P.253	Feedback disconnection detection time	0 ~ 600.0s	0.0s	<a href="#">202</a>
08-46	P.254	Feedback disconnection processing method	0: AEr alarm is reported and the inverter stops freely 1: After deceleration to stop, AEr alarm is reported 2: Continue to run, output disconnection alarm is reported around multifunction digital output terminal	0	<a href="#">202</a>
09-00	P.349	Encoder type	0 : ABZ 1 : ABZ (For synchronous motor) 2 : Resolver 1x synchronous motor standard encoder 3 : ABZ/UVW synchronous motor standard encoder	0	<a href="#">204</a>
09-01	P.350	Encoder pulse 1	0 ~ 20000	1024	<a href="#">205</a>
09-02	P.351	Encoder input type 1	0 : Off 1 : A/Phase B pulse wave , forward spin if Phase A is over Phase B for 90 degrees 2 : A/Phase B pulse wave , forward spin if Phase B is over Phase A for 90 degrees. 3 : Phase A :pulse wave , Phase B:directional sign , L:reverse spin , H:forward spin 4 : Phase A :pulse wave , Phase B: directional sign , L:forward spin , H:reverse spin	0	<a href="#">205</a>
09-03	P.352	PG error detection time	0 ~ 100.0s	1.0s	<a href="#">206</a>
09-04	P.353	Overspeed detection frequency	0 ~ 30.00Hz	4.00Hz	<a href="#">206</a>
09-05	P.354	Overspeed detection time	0 ~ 100.0s	1.0s	<a href="#">206</a>
09-06	P.355	Encoder pulse 2	0 ~ 20000	2500	<a href="#">207</a>
09-07	P.356	Encoder input type 2	0 : Off 1 : A/Phase B pulse wave, forward spin if Phase A is over Phase B for 90 degrees 2 : A/Phase B pulse wave , forward spin if Phase B is over Phase A for 90 degrees 3 : Phase A :pulse wave , Phase B:directional sign , L:reverse spin , H:forward spin 4 : Phase A :pulse wave , Phase B: directional sign , L:forward spin , H:reverse spin	0	<a href="#">207</a>
09-08	P.357	Frequency division output setting	1 ~ 255	1	<a href="#">208</a>

Appendix 1 Parameter table

Group	Parameter Number	Name	Setting Range	Default	Page	
09-09	P.358	Frequency division filter coefficient setting	0 ~ 255	0	<a href="#">208</a>	
09-10	P.359	Electronic gear ratio	0 ~ 65.535	1.000	<a href="#">208</a>	
09-11	P.360	Anti-reversal detection pulse	0 ~ 65535	0	<a href="#">208</a>	
09-12	P.361	Reversal detection frequency	0 ~ 65535	0	<a href="#">208</a>	
09-13	P.124	Expansion card version	Read only	Read	<a href="#">209</a>	
09-14	P.363	Z phase correction allowance	0.0° : Off	15.0°	<a href="#">209</a>	
			0.1°~360.0° : Z phase pulse correction			
09-15	P.364	Z phase DV1/DV2 alarm enabled	0 : Off	1	<a href="#">209</a>	
			1 : Z phase DV1/DV2 alarm valid			
09-16	P.386	Encoder signal detection setting	1 digit : PG302L hardware disconnection check	0 : Off	1	<a href="#">206</a>
				1 : Valid		
			2 digit : A1/B1 phase sequence check	0 : Off		
				1 : Valid		
09-17	P.416	Encoder installation transmission ratio	0 ~ 65.535	1.000	<a href="#">210</a>	
10-00	P.10	DC brake operating frequency	0 ~ 120.00Hz	3.00Hz	<a href="#">215</a>	
10-01	P.11	DC brake operating time	0 ~ 60.0s	0.5s	<a href="#">215</a>	
10-02	P.12	DC brake operating voltage	0 ~ 30.0%: 7.5K and below	4.0%	<a href="#">215</a>	
			0 ~ 30.0%: 11K ~ 22K	2.0%		
10-03	P.151	Zero-speed control function selection	0: Off.	0	<a href="#">216</a>	
			1: In close-loop vector control (00-21(P.300)/00-22(P. 370) =4) mode do zero-speed; In V/F close-loop control (00-21(P.300)/00-22(P. 370) =1) mode do DC voltage breaking.			
			2: In close-loop vector mode do zero-servo.			
10-04	P.152	Voltage at zero-speed control	0 ~ 30.0%: 7.5K and below	4.0%	<a href="#">216</a>	
			0 ~ 30.0%: from 11K to 22K	2.0%		
10-05	P.242	DC brake before inverter start	0: Off	0	<a href="#">217</a>	
			1: Before starting operate DC brake first.			
10-06	P.243	DC brake time before inverter start	0 ~ 60.0s	0.5s	<a href="#">217</a>	
10-07	P.244	DC brake voltage before inverter start	0 ~ 30.0%: 7.5K (included) and below	4.0%	<a href="#">217</a>	
			0 ~ 30.0%: 11K ~ 22K	2.0%		
10-08	P.150	Restart mode selection	XX0: No frequency search.	0	<a href="#">218</a>	
			XX1: Direct frequency search			
			XX2: Decrease voltage mode			
			X0X: Power on once.			
			X1X: Start each time.			
			X2X: Only instantaneous stop and restart			
			0XX: No rotation direction detection.			
			1XX: Rotation direction detection.			
2XX:00-15(P.78)=0, rotation direction detection ; 00-15(P.78)=1/2, no rotation direction detection.						

Group	Parameter Number	Name	Setting Range	Default	Page
10-09	P.57	Restart idling time	0 ~ 30.0s	99999	<a href="#">218</a>
			99999: Off.		
10-10	P.58	Restart rising time	0 ~ 60.0s: 7.5K (included)and below.	5.0s	<a href="#">218</a>
			0 ~ 60.0s: 11K ~ 22K	10.0s	
10-11	P.61	Remote control function	0: Off	0	<a href="#">220</a>
			X1: Remote control function, frequency save in memory		
			X2: Remote control function, frequency won't save		
			X3: Remote control function, frequency won't save, clear frequency setting every time STF/STR "turn off".		
			X4: Remote control function, frequency save, the interval between two frequency memory time is not les than 5s		
1X: Target frequency range 01-01(P.2)~01-00(P.1). The target frequency comes from the setting during RH, RM operation.					
10-12	P.65	Auto reset function	0: Off.	0	<a href="#">222</a>
			1: When over-voltage, inverter will reset.		
			2: When over-current, inverter will reset.		
			3: When either over-voltage or over-current, inverter will reset.		
			4: When any alarm occur, inverter will reset.		
10-13	P.67	Auto reset times	0: Off.	0	<a href="#">222</a>
			1 ~ 10: If the alarm exceeds 10-13(P.67) times, inverter will not reset.		
10-14	P.68	Auto reset waiting time	0 ~ 360.0s	1.0s	<a href="#">222</a>
10-15	P.69	Auto reset times count	Read only	0	<a href="#">222</a>
10-16	P.119	Forward and reverse rotation dead time	0 ~ 3000.0s	0.0s	<a href="#">223</a>
10-17	P.159	Energy-saving control function	0: Off.	0	<a href="#">223</a>
			1: Energy-saving mode.		
10-18	P.229	Dwell function selection	0: Off.	0	<a href="#">224</a>
			1: Backlash compensation function.		
			2: Acceleration and deceleration interrupt waiting function.		
10-19	P.230	Dwell frequency at acceleration	0 ~ 650.00Hz	1.00Hz	<a href="#">224</a>
10-20	P.231	Dwell time at acceleration	0 ~ 360.0s	0.5s	<a href="#">224</a>
10-21	P.232	Dwell frequency at deceleration	0 ~ 650.00Hz	1.00Hz	<a href="#">224</a>
10-22	P.233	Dwell time at deceleration	0 ~ 360.0s	0.5s	<a href="#">224</a>

Appendix 1 Parameter table

Group	Parameter Number	Name	Setting Range	Default	Page
10-23	P.234	Triangular wave function selection	0: Off.	0	<a href="#">225</a>
			1: If terminal function TRI is triggered, triangular wave function will on.		
			2: Triangular wave function is on at all time.		
10-24	P.235	Maximum amplitude	0 ~ 25.0%	10.0%	<a href="#">225</a>
10-25	P.236	Amplitude compensation at deceleration	0 ~ 50.0%	10.0%	<a href="#">225</a>
10-26	P.237	Amplitude compensation at acceleration	0 ~ 50.0%	10.0%	<a href="#">225</a>
10-27	P.238	Amplitude acceleration time	0 ~ 360.00s/0 ~ 3600.0s	10.00s	<a href="#">225</a>
10-28	P.239	Amplitude deceleration time	0 ~ 360.00s/0 ~ 3600.0s	10.00s	<a href="#">225</a>
10-29	P.247	Switch to commercial supply MC switchover interlock time	0.1 ~ 100.0s	1.0s	<a href="#">226</a>
10-30	P.248	Switch to commercial supply waiting time	0.1 ~ 100.0s	0.5s	<a href="#">226</a>
10-31	P.249	From inverter to commercial power supply switchover frequency	0 ~ 60.00Hz	99999	<a href="#">226</a>
			99999: Off.		
10-32	P.250	Automatic switchover frequency range	0~10.00Hz: After switching from inverter operation to commercial power supply operation, after inverter start command (STF/STR) is OFF, switch to inverter operation.	99999	<a href="#">226</a>
			99999: After switching from inverter operation to commercial power supply operation, after inverter start command (STF/STR) is OFF, switch to inverter operation, and slow down to stop.		
10-33	P.273	When input power fail stop option	0: Off.	0	<a href="#">229</a>
			1: No undervoltage avoidance (If undervoltage or power fail, the motor decelerates to stop.)		
			2: No undervoltage avoidance (If undervoltage or power fail, the motor decelerates to stop. Motor re-accelerates if power restores during the deceleration to stop.)		
			11: Undervoltage avoidance (If undervoltage or power fail, the motor decelerates to stop.)		
			12: Undervoltage avoidance (If undervoltage or power fail, the motor decelerates to stop. Motor re-accelerates if power restores during the deceleration to stop.)		
10-34	P.274	When input power fail subtracted frequency at deceleration start	0 ~ 20.00Hz	3.00Hz	<a href="#">229</a>
10-35	P.275	When input power fail subtraction starting frequency	0 ~ 120.00Hz: When output frequency ≥ 10-35 (P.275) , Motor decelerates from “output frequency - 10-34(P.274)” ; When output frequency < 10-35 (P.275), deceleration from output frequency	50.00Hz	<a href="#">229</a>
			99999: Motor decelerates from “output frequency - 10-34(P.274)”		



Group	Parameter Number	Name	Setting Range	Default	Page
10-36	P.276	Deceleration time during input power failure 1	0~360.00s/0~3600.0s	5.00s	<a href="#">229</a>
10-37	P.277	Deceleration time during input power failure 2	0~360.00s/0~3600.0s: Set deceleration time below the set frequency of 10-38 (P.278) 99999: Set deceleration time to the set frequency of 10-38 (P.278)	99999	<a href="#">229</a>
10-38	P.278	When input power fail deceleration time switchover frequency	0 ~ 650.00Hz	50.00Hz	<a href="#">229</a>
10-39	P.279	UV avoidance voltage gain	0 ~ 200.0%	100.0%	<a href="#">229</a>
10-40	P.700	VF separated voltage source	0: Given by digital 10-41(P.701). 1: Given by analog or HDI pulse signal.	0	<a href="#">231</a>
10-41	P.701	VF separated voltage digital	0 ~ 440.00V/0~220.00V	According to voltage	<a href="#">231</a>
10-42	P.702	VF separated voltage Acc time	0 ~ 1000.0s	0.0s	<a href="#">231</a>
10-43	P.703	VF separated voltage Dec time	0 ~ 1000.0s	0.0s	<a href="#">231</a>
10-44	P.704	VF separated stop selection	0: Frequency/voltage independently decreases to 0. 1: After the voltage decreases to 0, frequency decreases.	0	<a href="#">231</a>
10-45	P.267	Regeneration avoid function selection	0: Off. 1: Regeneration avoid function is always on. (Automatic calculate Acc/Dec speed ) 2: Regeneration avoid function is on only during constant speed operation (Automatic calculate Acc/Dec speed ) 11: Regeneration avoid function is always on. (Manual mode, Acc/Dec speed is set by 10-49(P.271) and 10-50(P.272)) 12: Regeneration avoid function is on only during constant speed operation (Manual mode, Acc/Dec speed is set by 10-49(P.271) and 10-50(P.272))	0	<a href="#">232</a>
10-46	P.268	Regeneration avoid action voltage level	220V : 155 ~ 400V 440V : 310 ~ 800V	380V 760V	<a href="#">232</a>
10-47	P.269	Regeneration avoid function DC bus voltage detection sensitivity at deceleration	0: Prevent regeneration avoidance from failing according to bus voltage change rate 1 ~ 5: Set the sensitivity to detect the bus voltage change rate. Larger number, higher sensitivity.	0	<a href="#">232</a>
10-48	P.270	Regeneration avoid frequency compensation value	0 ~ 10.00Hz: Set the limit value of regenerative avoid frequency compensation. 99999: Off.	6.00Hz	<a href="#">232</a>
10-49	P.271	Regeneration avoid voltage gain coefficient	0 ~ 400.0%/0 ~ 40.0%	100.0%	<a href="#">232</a>

Appendix 1 Parameter table

Group	Parameter Number	Name	Setting Range	Default	Page
10-50	P.272	Regeneration avoid frequency gain coefficient	0 ~ 400.0%/0 ~ 40.0%	100.0%	<a href="#">232</a>
10-51	P.264	Over excitation deceleration	0: Off. 1: Over excitation deceleration is valid.	0	<a href="#">233</a>
10-52	P.265	Over excitation current level	0 ~ 200.0%	150.0%	<a href="#">233</a>
10-53	P.266	Over excitation gain	1.00 ~ 1.40	1.10	<a href="#">233</a>
10-54	P.362	Short-circuit brake time when PM motor start	0~60.0s	0.0s	<a href="#">233</a>
10-55	P.780	PLC function selection	0: Off 1: PLC RUN signal from digital input terminal function 60 or 10-56 (P.781)。 2 : PLC RUN signal from digital input terminal function 60	0	<a href="#">234</a>
10-56	P.781	PLC run	0: Off 1: PLC RUN	0	<a href="#">234</a>
10-57	P.782	PLC program erase function	0: Off 1: Erase the PLC program, after erase success parameter value is 0.	0	<a href="#">234</a>
10-58	P.783	PLC choose register to monitor	0~329	0	<a href="#">234</a>
10-59	P.784	PLC register monitoring value	Read only	Read	<a href="#">234</a>
11-00	P.320	Speed control proportional coefficient 1	0 ~ 200.0	10	<a href="#">237</a>
11-01	P.321	Speed control integral time 1	0 ~ 20.000s	0.50s	<a href="#">237</a>
11-02	P.322	PI coefficient switchover frequency 1	11-25 ( P.414 ) ~ 11-05 ( P.325 ) Hz	5.00Hz	<a href="#">237</a>
11-03	P.323	Speed control proportional coefficient 2	0 ~ 200.0	10	<a href="#">237</a>
11-04	P.324	Speed control integral time 2	0 ~ 20.000s	0.50s	<a href="#">237</a>
11-05	P.325	PI coefficient switchover frequency 2	11-02(P.322) ~ 650.00Hz	10.00	<a href="#">237</a>
11-06	P.326	Current control proportional coefficient	0 ~ 20	0	<a href="#">237</a>
11-07	P.327	PM motor type	0: SPM 1: IPM	0	<a href="#">238</a>
11-08	P.328	PM motor initial position detection method	0: Pull in. 1: High frequency pulse	0	<a href="#">238</a>
11-09	P.329	PM motor acceleration id	0 ~ 200%	80%	<a href="#">238</a>
11-10	P.330	PM motor constant speed id	0 ~ 200%	0%	<a href="#">238</a>
11-11	P.331	PM motor estimated speed filtering time	0 ~ 1000ms	2ms	<a href="#">238</a>
11-12	P.401	Torque command	-400.0 ~ 400.0%	0.0%	<a href="#">239</a>
11-13	P.402	Speed limit	-120% ~ 120%	0%	<a href="#">239</a>
11-14	P.403	Speed limit bias	0 ~ 120%	10%	<a href="#">239</a>
11-15	P.404	Torque filter time	0 ~ 1000ms	0ms	<a href="#">239</a>

Group	Parameter Number	Name	Setting Range	Default	Page
11-16	P.405	Torque command source	0: Given by 11-12(P.401).	0	<a href="#">239</a>
			1: Given by analog or pulse input.		
			2: Given by communication mode.		
11-17	P.406	Speed limit selection	0: Speed is limited according to 11-13 (P.402) and 11-14 (P.403)	0	<a href="#">239</a>
			1: Frequency command source(it is decided according to 00-16(P.79) )		
11-18	P.407	Unidirectional speed limit bias	0: Off	1	<a href="#">239</a>
			1: Unidirectional speed limit bias is valid.		
11-19	P.408	Forward-rotation electronic torque limit	0 ~ 400.0%	200.0%	<a href="#">241</a>
11-20	P.409	Reverse-rotation regenerative torque limit	0 ~ 400.0%	200.0%	<a href="#">241</a>
11-21	P.410	Reverse-rotation electronic torque limit	0 ~ 400.0%	200.0%	<a href="#">241</a>
11-22	P.411	Forward-rotation regenerative torque limit	0 ~ 400.0%	200.0%	<a href="#">241</a>
11-23	P.412	Zero-speed proportional coefficient	0~200.00	10.00	<a href="#">237</a>
11-24	P.413	Zero-speed integral time	0~20.000s	0.500s	<a href="#">237</a>
11-25	P.414	Zero-speed switching frequency	0~11-02(P.322)Hz	5.00Hz	<a href="#">237</a>
11-26	P.415	IM motor estimated speed filtering time	0-100.00ms	4.0ms	238
11-30	P.371	Second motor speed control proportional coefficient 1	0 ~ 2000	10.0	<a href="#">242</a>
			99999		
11-31	P.372	Second motor speed control integral time 1	0 ~ 20.00s	0.50s	<a href="#">242</a>
			99999		
11-32	P.373	Second motor PI coefficient switchover frequency 1	0 ~ 11-35 (P.376)Hz	5.00Hz	<a href="#">242</a>
			99999		
11-33	P.374	Second motor speed control proportional coefficient 2	0 ~ 2000	10.0	<a href="#">242</a>
			99999		
11-34	P.375	Second motor speed control integral time 2	0 ~ 20.00s	0.50s	<a href="#">242</a>
			99999		
11-35	P.376	Second motor PI coefficient switchover frequency 2	11-32(P.373)~650.00Hz	10.00Hz	<a href="#">242</a>
			99999		
11-36	P.377	Second motor current control proportional coefficient	0 ~ 20	0	<a href="#">242</a>
			99999		
11-37	P.378	Second PM motor type	0: SPM	0	<a href="#">243</a>
			1: IPM		
			99999		
11-38	P.379	Second PM motor initial position detection method	0: Pull in.	0	<a href="#">243</a>
			1: High frequency pulse		
			99999		

Appendix 1 Parameter table

Group	Parameter Number	Name	Setting Range	Default	Page
11-39	P.380	Second PM motor acceleration id	0 ~ 200% 99999	80%	<a href="#">243</a>
11-40	P.381	Second PM motor constant speed id	0 ~ 200% 99999	0%	<a href="#">243</a>
11-41	P.382	Second PM motor estimated speed filtering time	0 ~ 1000ms 99999	2ms	<a href="#">243</a>
11-43	P.366	PM motor speed estimation observer Kp	0 ~ 65000	30	<a href="#">243</a>
11-44	P.367	PM motor speed estimation observer Ki	0 ~ 65000	10000	<a href="#">243</a>
11-48	P.387	Speed loop zero speed bandwidth	0~100.0Hz	5.0Hz	<a href="#">244</a>
11-49	P.388	Speed loop low speed bandwidth	0~100.0Hz	5.0Hz	<a href="#">244</a>
11-50	P.389	Speed loop high speed bandwidth	0~100.0Hz	5.0Hz	<a href="#">244</a>
11-51	P.390	Speed loop self-tuning selection	0: Off 1: Speed loop self-setting is effective	0	<a href="#">244</a>
11-52	P.368	Speed loop outputs low pass filter time constant	0~500.0ms	0.0ms	<a href="#">244</a>
11-58	P.440	PM motor id given low-pass filter time constant	0 ~ 65.535s	0.200s	<a href="#">244</a>
12-00	P.420	Homing mode	0 ~ 2123	0	<a href="#">247</a>
12-01	P.421	Homing,first high speed	0 ~ 650.00Hz	10.00Hz	<a href="#">247</a>
12-02	P.422	Homing,second high speed	0 ~ 650.00Hz	2.00Hz	<a href="#">247</a>
12-03	P.423	Pulse deviation of original point	-30000~30000	0	<a href="#">247</a>
12-04	P.424	Position command source	0: External pulse. 1: Relative position. 2: Absolute position.	0	<a href="#">250</a>
12-05	P.425	Position control proportional gain	0 ~ 65535	10	<a href="#">250</a>
12-06	P.426	Position control feed-forward gain coefficient	0 ~ 65535	0	<a href="#">250</a>
12-07	P.427	Position control feed-forward low pass filter time	0 ~ 65535ms	100ms	<a href="#">250</a>
12-08	P.428	External pulse position control speed limit	0 ~ 650.00Hz	10.00Hz	<a href="#">250</a>
12-09	P.429	Position reach margin	0 ~ 65535	40	<a href="#">250</a>
12-10	P.430	Zero servo gain	0 ~ 100	5	<a href="#">252</a>
12-11	P.431	Single point positioning	0~65535	0	<a href="#">252</a>
12-12	P.432	Single point positioning frequency	0~650.00Hz	0.00Hz	<a href="#">252</a>
12-13	P.433	Zero speed threshold	0~650.00Hz	0.50Hz	<a href="#">250</a>
12-14	P.434	Position command response option	0~2	0	<a href="#">250</a>
12-20	P.450	Cycle number of position command 1	-30000~30000	0	<a href="#">253</a>
12-21	P.451	Pulse number of position command 1	-30000~30000	0	<a href="#">253</a>
12-22	P.452	Cycle number of position command 2	-30000~30000	0	<a href="#">253</a>
12-23	P.453	Pulse number of position command 2	-30000~30000	0	<a href="#">253</a>
12-24	P.454	Cycle number of position command 3	-30000~30000	0	<a href="#">253</a>
12-25	P.455	Pulse number of position command 3	-30000~30000	0	<a href="#">253</a>

Group	Parameter Number	Name	Setting Range	Default	Page
12-26	P.456	Cycle number of position command 4	-30000~30000	0	<a href="#">253</a>
12-27	P.457	Pulse number of position command 4	-30000~30000	0	<a href="#">253</a>
12-28	P.458	Cycle number of position command 5	-30000~30000	0	<a href="#">253</a>
12-29	P.459	Pulse number of position command 5	-30000~30000	0	<a href="#">253</a>
12-30	P.460	Cycle number of position command 6	-30000~30000	0	<a href="#">254</a>
12-31	P.461	Pulse number of position command 6	-30000~30000	0	<a href="#">254</a>
12-32	P.462	Cycle number of position command 7	-30000~30000	0	<a href="#">254</a>
12-33	P.463	Pulse number of position command 7	-30000~30000	0	<a href="#">254</a>
12-34	P.464	Cycle number of position command 8	-30000~30000	0	<a href="#">254</a>
12-35	P.465	Pulse number of position command 8	-30000~30000	0	<a href="#">254</a>
12-36	P.466	Cycle number of position command 9	-30000~30000	0	<a href="#">254</a>
12-37	P.467	Pulse number of position command 9	-30000~30000	0	<a href="#">254</a>
12-38	P.468	Cycle number of position command 10	-30000~30000	0	<a href="#">254</a>
12-39	P.469	Pulse number of position command 10	-30000~30000	0	<a href="#">254</a>
12-40	P.470	Cycle number of position command 11	-30000~30000	0	<a href="#">254</a>
12-41	P.471	Pulse number of position command 11	-30000~30000	0	<a href="#">254</a>
12-42	P.472	Cycle number of position command 12	-30000~30000	0	<a href="#">254</a>
12-43	P.473	Pulse number of position command 12	-30000~30000	0	<a href="#">254</a>
12-44	P.474	Cycle number of position command 13	-30000~30000	0	<a href="#">254</a>
12-45	P.475	Pulse number of position command 13	-30000~30000	0	<a href="#">254</a>
12-46	P.476	Cycle number of position command 14	-30000~30000	0	<a href="#">254</a>
12-47	P.477	Pulse number of position command 14	-30000~30000	0	<a href="#">254</a>
12-48	P.478	Cycle number of position command 15	-30000~30000	0	<a href="#">254</a>
12-49	P.479	Pulse number of position command 15	-30000~30000	0	<a href="#">254</a>
13-00	P.89	Slip compensation coefficient	0 ~ 10	0	<a href="#">256</a>
13-01	P.246	Modulation coefficient	0.90 ~ 1.20	1.00	<a href="#">256</a>
13-02	P.285	Low frequency vibration suppression factor	0 ~ 8	5	<a href="#">257</a>
13-03	P.286	High frequency vibration suppression factor	XX00 ~ XX15 00XX ~ 15XX	509	<a href="#">257</a>
13-05	P.216	Acceleration torque boost	-60.0 ~ 60.0%	0.0%	<a href="#">257</a>
14-00	P.600	Tension control parameter	0 : Off 1 : Open loop torque control mode ( under closed loop vector control mode ) 2 : Closed loop speed control mode 3 : Closed loop torque control mode ( under closed loop vector control mode ) 4 : Constant linear speed control mode	0	<a href="#">260</a>
14-01	P.601	Rolling mode	0 : Wind roll 1 : Release roll	0	<a href="#">260</a>

Appendix 1 Parameter table

Group	Parameter Number	Name	Setting Range	Default	Page
14-02	P.602	Tightening roll option when releasing	0 : Forbid tightening material during startup	0	<a href="#">260</a>
			1 : Allow tightening material during startup		
14-03	P.603	Mechanical transmission ratio	0 ~ 300.00	1.00	<a href="#">260</a>
14-04	P.604	Tension setting source	0 : Parameter 14-05 ( P.605 ) setting	0	<a href="#">261</a>
			1 : Analog value or PULSE input setting		
			2 : Communication setting		
14-05	P.605	Tension setting	0 ~ 30000N	0N	<a href="#">261</a>
14-06	P.606	Maximum tension	0 ~ 30000N	0N	<a href="#">261</a>
14-07	P.607	Zero-speed tension increase	0 ~ 50.0%	0.0%	<a href="#">261</a>
14-08	P.608	Zero-speed threshold	0 ~ 30.00Hz	0.00Hz	<a href="#">261</a>
14-09	P.609	Tension taper	0 ~ 100.0%	0%	<a href="#">261</a>
14-10	P.654	Taper compension correction value	0 ~ 10000mm	0mm	<a href="#">261</a>
14-11	P.610	Winding calculation method options	0 : Calculate by linear speed	0	<a href="#">262</a>
			1 : Calculate by thickness(encoder of motor side) , pulse signal connects to A1/B1 of PG card		
			2 : Calculate by thickness (encoder of winding shaft) , pulse signal input to terminal M2		
			3 : Analog value of pulse input		
14-12	P.650	Calculate winding memory control by thickness calculation	0 : Do not save winding radius when power outage or calculation stops	0	<a href="#">262</a>
			1 : Save winding radius when there's a power outage or calculation stops , and use saved winding radius as initial winding radius when power recovers or calculation restarts		
14-13	P.611	Maximum winding radius	0 ~ 10000mm	500mm	<a href="#">262</a>
14-14	P.612	Winding diameter	0 ~ 10000mm	100mm	<a href="#">262</a>
14-15	P.613	Initial winding radius source	0: Initial winding radius is determined by parameter 14-16(P.614) ~ 14-18(P.616)	0	<a href="#">262</a>
			1 : Initial winding radius is determined by analog value		
14-16	P.614	Initial winding radius 1	1 ~ 10000mm	100mm	<a href="#">263</a>
14-17	P.615	Initial winding radius 2	1 ~ 10000mm	100mm	<a href="#">263</a>
14-18	P.616	Initial winding radius 3	1 ~ 10000mm	100mm	<a href="#">263</a>
14-19	P.617	Winding radius filter time	0 ~ 1000ms	0ms	<a href="#">263</a>
14-20	P.618	Current winding radius	0 ~ 10000mm	0mm	<a href="#">263</a>
14-21	P.619	Pulse per cycle	1 ~ 60000	1	<a href="#">263</a>
14-22	P.620	Cycle per layer	1 ~ 10000	1	<a href="#">263</a>
14-23	P.621	Material thickness setting source	0 : Material thickness is set by parameter 14-24 ( P.622 ) ~ 14-27 ( P.625 )	0	<a href="#">263</a>
			1 : Material thickness is determined analog value		

Group	Parameter Number	Name	Setting Range	Default	Page
14-24	P.622	Material thickness 0	0.01 ~ 100.00mm	0.01mm	<a href="#">263</a>
14-25	P.623	Material thickness 1	0.01 ~ 100.00mm	0.01mm	<a href="#">263</a>
14-26	P.624	Material thickness 2	0.01 ~ 100.00mm	0.01mm	<a href="#">263</a>
14-27	P.625	Material thickness 3	0.01 ~ 100.00mm	0.01mm	<a href="#">263</a>
14-28	P.626	Maximum thickness	0.01 ~ 100.00mm	1.00mm	<a href="#">263</a>
14-29	P.627	Linear speed input source	0 : Off	0	<a href="#">265</a>
			1 : Analog value or pulse input		
			2 : Communication setting		
14-30	P.628	Maximum linear speed	0.1 ~ 6500.0m/min	1000.0m/min	<a href="#">265</a>
14-31	P.629	Calculate R minimum linear speed	0.1 ~ 6500.0m/min	200.0m/min	<a href="#">265</a>
14-32	P.630	Actual linear speed	0 ~ 6500.0m/min	0.0m/min	<a href="#">265</a>
14-33	P.633	Mechanical inertia compensation coefficient	0 ~ 65535	0	<a href="#">266</a>
14-34	P.634	Material density	0 ~ 60000kg/ m <sup>3</sup>	0kg/ m <sup>3</sup>	<a href="#">266</a>
14-35	P.635	Material width	0 ~ 60000mm	0mm	<a href="#">266</a>
14-36	P.636	Friction compensation coefficient	0 ~ 50.0%	0.0%	<a href="#">265</a>
14-37	P.637	Material outage detection function	0 : Off	0	<a href="#">265</a>
			1 : Material outage detection function 1		
			2 : Material outage detection function 2		
			3: Material outage detection function 3		
14-38	P.638	Minimum speed detection	0.1 ~ 6500.0m/min	200.0m/min	<a href="#">265</a>
14-39	P.639	Error range detection	0.1 ~ 100.0%	10.0%	<a href="#">265</a>
14-40	P.640	Delay detection	0.1 ~ 60.0s	2.0s	<a href="#">265</a>
14-41	P.645	Pre-drive speed gain	-50.0% ~ 50.0%	0.0%	<a href="#">265</a>
14-42	P.646	Pre-drive torque increase	-50.0% ~ 50.0%	0.0%	<a href="#">265</a>
14-43	P.647	Pre-drive delay	0 ~ 65535ms	0ms	<a href="#">265</a>
14-44	P.656	Linear speed setting source	0 : Off	0	<a href="#">267</a>
			1 : Obtain linear speed via analog value or pulse input		
			2 : Obtain linear speed via communication		
14-45	P.657	Linear speed setting	0 ~ 6500.0m/min	0.0m/min	<a href="#">267</a>
14-46	P.658	Closed-loop tension limit standard	0 : Use rated frequency of motor as standard of limitation	0	<a href="#">267</a>
			1 : Use system linear speed as standard of limitation		
14-47	P.659	Closed-loop tension limit deviation	0.0% ~ 100.0%	0.0%	<a href="#">267</a>

Appendix 1 Parameter table

Group	Parameter Number	Name	Setting Range	Default	Page
15-00	P.900	User registered parameter 1	P parameter mode: 0~1299 Parameter group mode: 00-00~15-99	99999	<u>268</u>
15-01	P.901	User registered parameter 2		99999	<u>268</u>
15-02	P.902	User registered parameter 3		99999	<u>268</u>
15-03	P.903	User registered parameter 4		99999	<u>268</u>
15-04	P.904	User registered parameter 5		99999	<u>268</u>
15-05	P.905	User registered parameter 6		99999	<u>268</u>
15-06	P.906	User registered parameter 7		99999	<u>268</u>
15-07	P.907	User registered parameter 8		99999	<u>269</u>
15-08	P.908	User registered parameter 9		99999	<u>269</u>
15-09	P.909	User registered parameter 10		99999	<u>269</u>
15-10	P.910	User registered parameter 11		99999	<u>269</u>
15-11	P.911	User registered parameter 12		99999	<u>269</u>
15-12	P.912	User registered parameter 13		99999	<u>269</u>
15-13	P.913	User registered parameter 14		99999	<u>269</u>
15-14	P.914	User registered parameter 15		99999	<u>269</u>
15-15	P.915	User registered parameter 16		99999	<u>269</u>
15-16	P.916	User registered parameter 17		99999	<u>269</u>
15-17	P.917	User registered parameter 18		99999	<u>269</u>
15-18	P.918	User registered parameter 19		99999	<u>269</u>
15-19	P.919	User registered parameter 20		99999	<u>269</u>



## 7.2 Appendix 2 Alarm code list

Code	Screen display	Cause	Troubleshooting
ERROR	Error	<ol style="list-style-type: none"> <li>1.Low input voltage</li> <li>2.The reset function "RES" is on</li> <li>3.Bad connection between the control panel and main body</li> <li>4.Internal circuit malfunction</li> <li>5. CPU error</li> <li>6. Abnormal insulation of load to ground</li> </ol>	<ol style="list-style-type: none"> <li>1.Use a better power supply</li> <li>2.Shut off "RES"</li> <li>3.Ensure the keypad is connected firmly</li> <li>4.Replace the inverter.</li> <li>5.Restart the inverter</li> <li>6. Check the insulation of the motor cable and the three-phase winding of the motor</li> </ol>
OC0 Over-current when start	OC0		<ol style="list-style-type: none"> <li>1. Check whether the insulation layer of the motor power line is damaged</li> <li>2. Check whether a contactor is used in series on the output side of the inverter, the contactor's contacts will arc and leads to inverter detects overcurrent (please avoid this usage, please refer to manual for wiring details)</li> <li>3. The control circuit of the inverter is interfered with external noise (for example: the electromagnetic contactor frequently switches to power supply load), it is recommended to add magnetic rings on output line of the electromagnetic contactor, and add magnetic ring with 2~3 windings on control terminal input signal on inverter.</li> <li>4. If alarm OC0 when the motor is disconnected, it needs to be sent to the factory for inspection.</li> </ol>
OC1 Over-current during acceleration	OC1	The output current is two times larger than the rated current of the inverter or the motor is short.	<ol style="list-style-type: none"> <li>1. It is recommended to increase the acceleration time P.7 (01-06)</li> <li>2. Check the insulation condition of the motor power line (for example: the insulation of the three-phase motor is short to ground, the power line is short-circuited, or short circuit between power line and the metal part of the electric cabinet)</li> <li>3. Check whether the base frequency parameter P.3 (01-03) of the inverter is the same with the rated frequency of the motor</li> </ol>
OC2 Over-current at constant speed	OC2		<ol style="list-style-type: none"> <li>1. It is recommended to reduce the load to eliminate motor stall and transmission mechanism jam</li> <li>2. Check the insulation condition of the motor power line (for example: the insulation of the three-phase motor is short to ground, the power line is short-circuited, or short circuit between power line and the metal part of the electric cabinet)</li> <li>3. Check whether the selection of the inverter power is too low</li> </ol>

Appendix 3 Warning Code List

Code	Screen display	Cause	Troubleshooting
OC3 Over-current during deceleration	OC3	The output current is two times larger than the rated current of the inverter or the motor is short.	<ol style="list-style-type: none"> <li>1. It is recommended to increase the deceleration time P.8 (01-07)</li> <li>2. It is recommended to set the base voltage parameter P.19 (01-04) equal to power supply voltage</li> <li>3. It is recommended to add braking unit and braking resistor</li> </ol>
OV0 Over-voltage when start	OV0	<p>The voltage between terminals (+ / P)-(- / N) is too high or the motor leaks to ground;</p> <p>The external power supply line has large power equipment start and stop affecting the power grid surge</p>	<ol style="list-style-type: none"> <li>1. Check whether the input power voltage is abnormal</li> <li>2. Check whether the motor is grounded (if so, it is recommended to remove the ground wire after turning off the power)</li> <li>3. Check the insulation condition of the motor power line (for example: the insulation of the three-phase motor is short to ground, the power line is short-circuited, or short circuit between power line and the metal part of the electric cabinet)</li> </ol>
OV1 Over-voltage during acceleration	OV1		<ol style="list-style-type: none"> <li>1. Check whether the input power voltage is abnormal</li> <li>2. Check whether the motor is grounded (if so, it is recommended to remove the ground wire after turning off the power)</li> <li>3. Check the insulation condition of the motor power line (for example: the insulation of the three-phase motor is short to ground, the power line is short-circuited, or short circuit between power line and the metal part of the electric cabinet)</li> </ol>
OV2 Over-voltage at constant speed	OV2		<ol style="list-style-type: none"> <li>1. Check whether the input power voltage is abnormal</li> <li>2. Check whether the motor is grounded (if so, it is recommended to remove the ground wire after turning off the power)</li> <li>3. It is recommended to add an input AC reactor at the input end of the inverter</li> <li>4. Check the insulation condition of the motor power line (for example: the insulation of the three-phase motor is short to ground, the power line is short-circuited, or short circuit between power line and the metal part of the electric cabinet)</li> </ol>
OV3 Over-voltage during deceleration	OV3		<ol style="list-style-type: none"> <li>1. It is recommended to increase the deceleration time P.8 (01-07)</li> <li>2. It is recommended to add braking unit and braking resistor</li> <li>3. Set the base voltage parameter P.19 (01-04) to 9999 or 99999</li> <li>4. Check the insulation condition of the motor power line (for example: the insulation of the three-phase motor is short to ground, the power line is short-circuited, or short circuit between power line and the metal part of the electric cabinet)</li> </ol>

Code	Screen display	Cause	Troubleshooting
THT IGBT module Overheat	THT	<ol style="list-style-type: none"> <li>1. IGBT module thermal relay actuate (overload warning)</li> <li>2. 01-03 (P.3) setting does not match the rated frequency of the motor</li> <li>3. Insufficient input power voltage causes inverter output capacity reduced.</li> <li>4. The three phase input connection of the motor is incorrect.</li> </ol>	<ol style="list-style-type: none"> <li>1. Check whether the inverter specifications match the motor specifications</li> <li>2. Check whether the load of the system is too heavy, and whether the output current displayed by the inverter exceeds the rated current</li> <li>3. Check whether the wiring of the motor is correct (usually 220V motor is delta (<math>\Delta</math>) connection, 380V motor is star (Y) connection, please check motor nameplate for connection details)</li> <li>4. Check whether the motor wiring is damaged</li> <li>5. Check whether the setting value of P.9 (06-00) matches the rated current of the motor</li> <li>6. Check whether the setting value of P.3 (01-03) matches the rated frequency of the motor</li> </ol>
THN Motor Overheated	THN	Thermal relay actuate	<ol style="list-style-type: none"> <li>1. Check whether the inverter specifications match the motor specifications</li> <li>2. Check whether the load of the system is too heavy, and whether the output current displayed by the inverter exceeds the rated current</li> <li>3. Check whether the wiring of the motor is correct (usually 220V motor is delta (<math>\Delta</math>) connection, 380V motor is star (Y) connection, please check motor nameplate for connection details)</li> <li>4. Check whether the motor wiring is damaged</li> <li>5. Check whether the setting value of P.9 (06-00) matches the rated current of the motor</li> <li>6. Check whether the setting value of P.3 (01-03) matches the rated frequency of the motor</li> </ol>
OHT External Overheat	OHT	External thermal relay actuate	<ol style="list-style-type: none"> <li>1. Check if the thermal relay used matches the motor (check motor nameplate)</li> <li>2. Reduce the load</li> <li>3. Check if the external IO signal is not connected or dropped</li> </ol>
OPT RS485 connector error	OPT	<ol style="list-style-type: none"> <li>1. Communication error , exceeding the retry limit.</li> <li>2. External noise interference</li> <li>3. The logic of the communication control program is unreasonable</li> <li>4. Disconnect time exceeding the limit.</li> </ol>	<ol style="list-style-type: none"> <li>1. Check whether the parameter (07-02(P.32), 07-00(P.33), 07-01(P.36), 07-07(P.154)) setting is the same with upper controller communication setting</li> <li>2. Check whether the RS485 DA+ and DB- terminal wiring is correctly connected to the upper controller</li> <li>3. Check whether the communication protocol of the upper controller is the same as the one declared in inverter</li> <li>4. The communication line is interfered by external noise (it is recommended to use twisted-pair shielded wire and connect to the signal ground correctly)</li> <li>5. The inverter internal communication port is damaged and needs to be returned to the factory for inspection.</li> </ol>

Appendix 3 Warning Code List

Code	Screen display	Cause	Troubleshooting
<b>PUE</b> PU connector error	<b>PUE</b>	1.Communication error , exceeding the retry limit. 2. External noise interference 3. The logic of the communication control program is unreasonable 4.Disconnect time exceeding the limit.	1.It is recommended to use twisted-pair shielded communication lines and the shielding layer is properly grounded 2.Check the communication program 3.Set the communication parameters correctly
<b>CbE</b> Expansion connector error	<b>CbE</b>		
<b>EEP</b> Memory error	<b>EEP</b>	ROM malfunction	If the alarm repeated, send the unit back to the dealer or the manufacturer to repair. Avoid frequent parameters modification and saving target frequency to EEPROM, please refer to 07-11 (P.34) and target frequency address H1002 to prevent damage.
<b>PID</b> PID error	<b>PID</b>	1.The capacity of the inverter or motor is not enough 2.PID target value or feedback value doesn't make sense 3.Peripheral devices malfunction 4. During PID control, the feedback signal is not connected or dropped	1.Use an inverter or a motor with bigger capacity. 2.Check the feedback gain value. Reset the target value according to the feedback. 3.Check all peripheral feedback devices of the system (sensors, potentiometer) and wirings.
<b>CPU</b> CPU error	<b>CPU</b>	Strong electromagnetic interference	Reduce peripheral interference.
<b>OLS</b> Stall prevention and protection	<b>OLS</b>	Over-loaded motor	1.Reduce the load 2.Increase 06-01(P.22) value.
<b>SCP</b> Short circuit over-current	<b>SCP</b>	1.Short circuit at output-end 2. Inverter false alarm SCP	1.Check if the output circuit is short and check the wiring 2. Inverter may be interfered by external electromagnetic noise, please improve the wiring (Note 1)
<b>NTC</b> Module overheat	<b>NTC</b>	The inverting part of IGBT module overheated	1.Lower the surrounding temperature and increase venting 2. Check if the cooling fan is functioning properly 3. Confirm whether the carrier frequency 00-11 (P.72) is set too large
<b>OL2</b> Torque overload	<b>OL2</b>	1. Motor overload 2. The value in 06-08 (P.155) and 06-09(P.156) doesn't make sense.	1.Reduce the load 2.Set 06-08 (P.155) and 06-09(P.156) properly
<b>IPF</b> Input power error	<b>IPF</b>	Input power error(phase loss)	Check if the power supply is normal.
<b>CPR</b> CPU error	<b>CPR</b>	CPU error	1.Check the wiring 2.Check the parameter setup 3.Reduce noise interference



Code	Screen display	Cause	Troubleshooting
<b>AEr</b> Terminal 4-5 error	<b>AEr</b>	1. The terminal 4-5 analog output disconnection 2. Disconnection when terminal 4-5 is used for PID feedback	1. Check parameter 02-24(P.184) 2. Check parameter 08-46(P.254)
<b>PG0</b> PG card communication error	<b>PG0</b>	PG card communication error	1. Check the wiring between PG card and encoder 2. Check if the encoder is a well-functioning unit
<b>PG1</b> Encoder input error	<b>PG1</b>	The input mode of the encoder is wrong	Check parameter 09-02(P.351)
<b>PG2</b> PG card feedback error	<b>PG2</b>	PG card feedback error	Please refer to the feedback control parameter description 09-01~09-05 /P.350~P.354
<b>PG3</b> Speed deviation error in close loop control I	<b>PG3</b>	Excessive speed deviation during close loop control	Please refer to the feedback control parameter description 09-01~09-05 /P.350~P.354
<b>PTC</b> Motor overheat	<b>PTC</b>	Motor overheat	1.reduce the load 2.set parameter 06-16(P.534)
<b>bEb</b> Material broke	<b>bEb</b>	Broken wire	Check if the feedback wire is broken.
<b>dv1</b> Missing Z pulse signal	<b>dv1</b>	1.PG card wrong wiring or wire broken 2.Encoder damaged	Fix the PG card wiring, make sure it is grounded and protected
<b>dv2</b> Noise in Z pulse signal	<b>dv2</b>	1.PG card wrong wiring or noise interfere 2.Encoder or PG card damaged	1.Keep wires away from noise 2. Fix the PG card wiring, make sure it is grounded and protected
<b>dv3</b> Reverse rotation detected	<b>dv3</b>	1.Z pulse signal error 2.The value of 09-02 (P.351)is set incorrectly 3. PG card wrong wiring or noise interfere	1.Autotune Z pulse signal 2.Set parameter 09-02(P.351) correctly 3. Fix the PG card wiring, make sure it is grounded and protected
<b>dv4</b> Reverse rotation prevention detected	<b>dv4</b>		

Appendix 3 Warning Code List

Code	Screen display	Cause	Troubleshooting
<b>GF</b> Output ground short circuit	GF	Shortage between output and ground	Check the motor wiring
<b>LF</b> Output phase loss	LF	Three phase output error	Check the UVW terminal on the inverter
<b>HDC</b> Hardware self-detect circuit error	HdC	Hardware self-detect circuit error	Send the unit back to the dealer or the manufacturer to repair
<b>ADE</b> Three-phase current sampling error	AdE	Three-phase current sampling circuit error	Send the unit back to the dealer or the manufacturer to repair
<b>EbE1</b> Expansion card error	EbE1	The first result of auto detection is not the same as the second.	Check the connection of the expansion card

Note 1: Do not turn on the power repeatedly before removing the cause of the alarm.

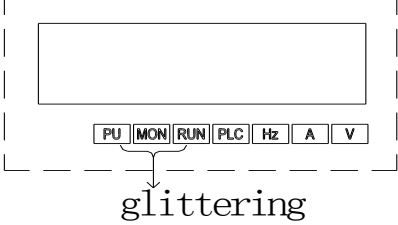
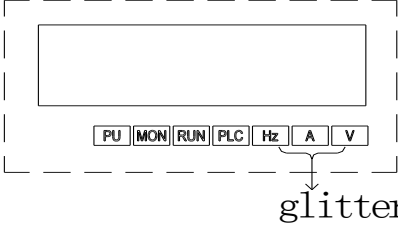
## 7.3 Appendix 3 Warning Code List

Code	Screen Display	Cause	Troubleshooting
Current stall		<p>When the output current is larger than Stall prevention operation level, the three lights on the left side of the screen flicker, indicating that the inverter is in current stall mode. In this case the motor may not run smoothly.</p>	<ol style="list-style-type: none"> <li>1. Check if the values of P.22, P.23, and P.66 are proper.</li> <li>2. Check if the values of P.7 and P.8 are too small.</li> <li>3. If there is rapid acceleration or deceleration, please extend the acceleration and deceleration time.</li> <li>4. Avoid sharp increase of load</li> <li>5. Check whether there is a short circuit in the motor terminal U/ t1-v/t2-w /T3.</li> </ol>
Voltage stall		<p>When the voltage between +/P and -/N is too high, the three lights on the right side of the screen flicker, indicating that the inverter is in voltage stall mode. Then the motor may not run smoothly.</p>	<ol style="list-style-type: none"> <li>1. Add a brake resistor between +/P and PR.</li> <li>2. Check if the values of P.7 and P.8 are too small</li> </ol>
<p><b>LV</b> Low voltage</p>		<p>Input voltage is low.</p>	<p>Supply with the normal voltage</p>

## 7.4 Appendix 4 Troubles and solutions

Troubles	Check points	
The motor does not run	Main circuit	<ul style="list-style-type: none"> <li>•Is the voltage between terminals R/L1-S/L2-T/L3 normal?</li> <li>• Is the POWER light on?</li> <li>•Is the wiring between the inverter and the motor correct?</li> </ul>
	Load	<ul style="list-style-type: none"> <li>•Is the load too heavy?</li> <li>•Is the motor rotor locked?</li> </ul>
	Parameters Setting	<ul style="list-style-type: none"> <li>•Is the startup frequency (01-11(P.13)) set too high?</li> <li>•Is the operation mode (00-16(P.79)) correct?</li> <li>•Is the upper limit frequency (01-00(P.1)) set to zero?</li> <li>•Is forward reverse rotation prevention (00-15(P.78)) limited?</li> <li>•Is the signal bias and gain (02-12~02-15, 02-25~02-28/P.192~P.199) correct?</li> <li>•Is the frequency jump (01-16~01-21/P.91~P.96) correct?</li> </ul>
	Control circuit	<ul style="list-style-type: none"> <li>•Is MRS function “on”? (relevant parameters 03-00~03-05(P.80~P.84、 P.86)</li> <li>•Is RES function “on”? (relevant parameters 03-00~03-05(P.80~P.84、 P.86)</li> <li>•Is the external thermal relay tripping?</li> <li>•Is there an alarm (ALARM light is on) that has not been reset?</li> <li>•Is the voltage/current signal correctly connected?</li> <li>• Are STF and STR functions correct? (relevant parameters (relevant parameters 03-00~03-05(P.80~P.84、 P.86)</li> <li>•Does the wiring of the control circuit fall off or have poor contact?</li> </ul>
Opposite motor rotation direction	<ul style="list-style-type: none"> <li>•Is the phase sequence of the wiring of the motor terminal (U/T1)/(V/T2)/(W/T3) correct?</li> <li>•Is the wiring of the start terminals STF and STR correct?</li> </ul>	
The motor cannot accelerate	<ul style="list-style-type: none"> <li>•Is the load too heavy?</li> <li>•Is stall prevention level (06-01(P.22)) correct?</li> <li>•Is torque compensation (01-10(P.0)) too high?</li> <li>•Is it limited by the upper limit frequency (01-00(P.1))?</li> </ul>	
Unsmooth acceleration and deceleration	<ul style="list-style-type: none"> <li>•Is the acceleration and deceleration time (01-06(P.7) and 01-07(P.8)) set correctly?</li> <li>•Is the acceleration/deceleration curve selection (01-05(P.29)) correct?</li> <li>•Does the voltage/current signal fluctuate due to noise?</li> </ul>	
Excessive motor current	<ul style="list-style-type: none"> <li>•Is the load too heavy?</li> <li>•Does the inverter capacity match the motor capacity?</li> <li>• Is torque compensation (01-10(P.0)) too high?</li> </ul>	
Speed fluctuation in operation	<ul style="list-style-type: none"> <li>• Does the voltage/current signal fluctuate due to noise?</li> <li>•Has the motor load changed?</li> <li>•Is the main circuit wiring too long?</li> </ul>	



## 7.5 Appendix 5 Optional equipment

### 7.5.1 Communication card

➤ PD302: Profibus communication card

Terminal form	Terminal name	Function name	Description
DB9	1	---	---
	2	---	---
	3	Rxd/Txd-P	Receive/transmit data-P
	4	CNTR-P 2)	Control-P
	5	DGND	Data ground
	6	VP 1)	Positive voltage
	7	---	---
	8	Rxd/Txd-N	Receive/transmit data-N
	9	---	---

1) The signal is only needed in bus cable endpoint station.

2) The signal is alternative.

◆ Ordering code:

NO.	Type	Name	Ordering Code
1	PD302	PD302 card	SNKPD302

➤ DN301: Device net communication card

◆ Device net ports definition

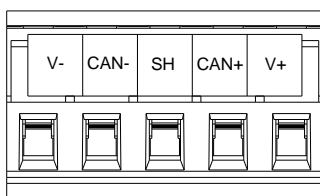

Terminal	Signal	Description
V+	V+	DC24V
CAN+	CAN+	Positive Signal wire
SH	SHIELD	Ground wire
CAN-	CAN-	Complex signal wire
V-	V-	0V

◆ Ordering code:

NO.	Type	Name	Ordering Code
1	DN301	DN301card	SNKDN301

Note: In order to install the expansion card, you need to purchase the expansion card installation accessory (SNKCMK301) at the same time.

➤ CP301: CANopen communication card

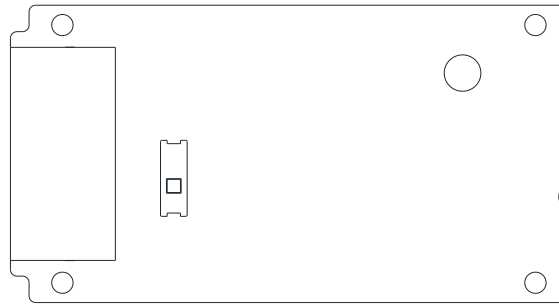

◆ RJ-45 Pin Definition

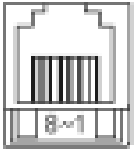

Socket

Pin	Symbol	Description
1	CAN_H	CAN_Hbus line (dominant high)
2	CAN_L	CAN_L bus line (dominant low)
3	CAN_GND	Ground /0V/V-
7	CAN_GND	Ground /0V/V-

◆ Function and specification

Connector	RJ-45
Port	2 Port
Transmission	CAN
Transmission	Using CAN standard line
Transmission	1M 500k 250K/280KF 125k 100k 50k
Protocol	CAN open Protocol

◆ CAN open communication wiring

Type: SNKCBLxxGTN2 (xx stands for 1R5,3,5,10)

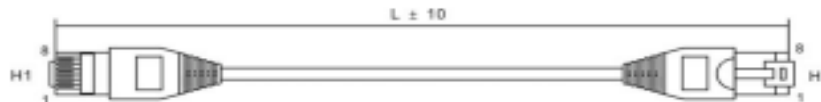

Item No.	Part No.	L(mm)
1	SNKCBL1R5GTN2	1500
2	SNKCBL3GTN2	3000
3	SNKCBL5GTN2	5000
4	SNKCBL10GTN2	10000

◆ Ordering code:

NO.	Type	Name	Ordering Code
1	CP301	CP301card	SNKCP301

Note: In order to install the expansion card, you need to purchase the expansion card installation accessory (SNKCMK301) at the same time.

➤ EP301 : Ethernet (Modbus TCP) card

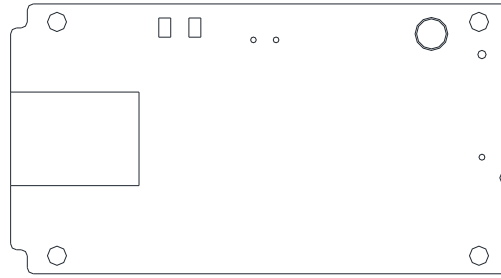

◆ Electric specification



Terminal form	Terminal name	Function name	Description
RJ45	1	Tx+	transmit data +
	2	Tx-	transmit data -
	3	RX+	Receive data +
	4	---	---
	5	---	---
	6	RX-	Receive data -
	7	---	---
	8	---	---

◆ CAN open communication wiring

Type : SNKCBLxxGTN2 (xx stands 1R5,3,5,10)



Item No.	Part No.	L(mm)
1	SNKCBL1R5GTN2	1500
2	SNKCBL3GTN2	3000
3	SNKCBL5GTN2	5000
4	SNKCBL10GTN2	10000

◆ Ordering code:

NO.	Type	Name	Ordering Code
1	EP301	EP301 card	SNKEP301

Note: In order to install the expansion card, you need to purchase the expansion card installation accessory (SNKCMK301) at the same time.

EC301 : EtherCAT card



◆ Electric specification



Terminal form	Terminal name	Function name	Description
RJ45	1	Tx+	transmit data +
	2	Tx-	transmit data -
	3	RX+	Receive data +
	4	---	---
	5	---	---
	6	RX-	Receive data +
	7	---	---
	8	---	---

◆ Ordering code:

NO.	Type	Name	Ordering Code
1	EC301	EC301 card	SNKEC301

Note: For EC301 to run normally, the software version of the inverter control board must be higher than V0.110.

## 7.5.2 I/O card

## ➤ EB362R

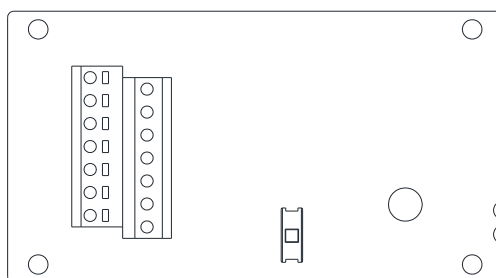

Terminal form	Terminal name	Function instructions	Terminal specification
Switch signal input	M10	There are totally 6 multi-function expanded control terminals. (Sink/Source can be switched)	Input impedance: 4.7 kΩ Action current: 5mA Voltage range: 10~28VDC Maximum frequency: 1kHz
	M11		
	M12		
	M13		
	M14		
	M15		
Relay output	A10, C10	Multi-function relay outputs 2 groups; A-C is normal open contact	Maximum voltage: 30VDC or 250VAC Maximum current: Resistive load: 5A NO Inductive load: 2A NO (cosΦ=0.4)
	A11, C11		
Public terminal	SD	The common terminal of Terminal M10~M15(SINK).	---
	PC	The common terminal of Terminal M10~M15 (SOURCE).	Output voltage: 24VDC±20% Maximum current: 200mA(share with control board)

## ◆ Ordering code:

NO.	Type	Name	Ordering Code
1	EB362R	EB362Rcard	SNKEB362R

Note: In order to install the expansion card, you need to purchase the expansion card installation accessory (SNKCMK301) at the same time.

➤ EB308R

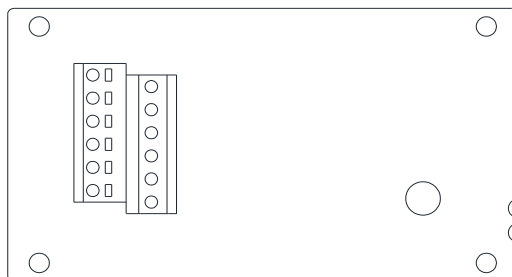

Terminal form	Terminal name	Function instructions	Terminal specification
Relay outputs	A10, C1	Multi-function relay outputs 8 groups; A-C is the normally open contact.	Maximum voltage: 30VDC or 250VAC Maximum current: Resistive load:5A NO Inductive load: 2A NO ( $\cos\Phi=0.4$ )
	A11, C1		
	A12, C2		
	A13, C2		
	A14, C3		
	A15, C3		
	A16, C4		
A17, C4			

◆ Ordering code:

NO.	Type	Name	Ordering Code
1	EB308R	EB308Rcard	SNKEB308R

Note: In order to install the expansion card, you need to purchase the expansion card installation accessory (SNKCMK301) at the same time.

7.5.3 PG card

➤ PG301C

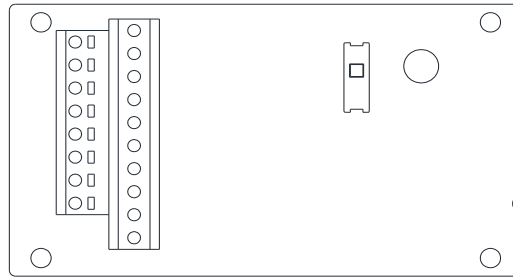

Terminal	Terminal Symbols	Function instruction	Terminal specification
Input	A1、B1、Z1	The input of the encoder signal supports open collector, voltage, line drive and push-pull input type.	Maximum frequency: 500KP/Sec
	$\overline{A1}$ 、 $\overline{B1}$ 、 $\overline{Z1}$		
Input	A2、B2	The input of pulse signal connects to the upper controller and supports open collector, voltage, line drive and push-pull input type.	Maximum frequency: 500KP/Sec
	$\overline{A2}$ 、 $\overline{B2}$		
Output	A1O	The open collector dividing frequency output is 1~255 times dividing frequency. The maximum output current is 50mA.	Maximum frequency: 500KP/Sec Maximum current: 50mA It can switch pull-up resistors under different voltages.
	B1O		
	Z1O		
	DCM		
Power	12V	12V Power	Voltage: $\pm 5\%$ Current: 200mA MAX
	5V	5V Power	
	DCM	Power grounding	

◆ Ordering code:

NO.	Type	Name	Ordering Code
1	PG301C	PG301Ccard	SNKPG301C

Note: In order to install the expansion card, you need to purchase the expansion card installation accessory (SNKCMK301) at the same time.

➤ PG301L

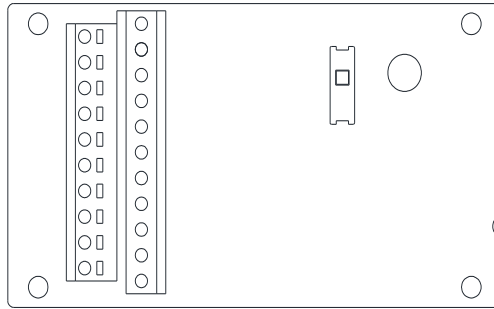

Terminal	Terminal Symbols	Function instruction	Terminal specification
Input	A1、B1、Z1	The input of the encoder signal supports open collector, voltage, line drive and push-pull input type.	Maximum frequency: 500KP/Sec
	$\overline{A1}$ 、 $\overline{B1}$ 、 $\overline{Z1}$		
	A2、B2	The input of pulse signal connects to the upper controller and supports open collector, voltage, line drive and push-pull input type.	Maximum frequency: 500KP/Sec
	$\overline{A2}$ 、 $\overline{B2}$		
Output	AO、BO、ZO	The line-drive dividing frequency output is 1 ~ 255 times dividing frequency.	Maximum output voltage: 5V Maximum current: 50mA Maximum frequency: 500KP/Sec
	$\overline{AO}$ 、 $\overline{BO}$ 、 $\overline{ZO}$		
Power	12V	12V Power	Voltage: $\pm 5\%$ Current: 200mA MAX
	5V	5V Power	
	DCM	Power grounding	

◆ Ordering code:

NO.	Type	Name	Ordering Code
1	PG301L	PG301Lcard	SNKPG301L

Note: In order to install the expansion card, you need to purchase the expansion card installation accessory (SNKCMK301) at the same time.



➤ PG302L

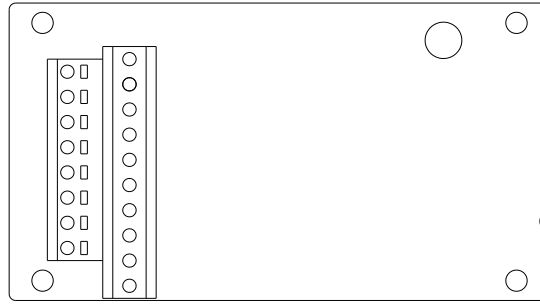

Terminal	Name	Function instruction	Terminal specification
Input	S1、S2	Resolver signal input	3.5±0.175Vrms , 10kHz
	$\overline{S3}$ 、 $\overline{S4}$		
	A2、B2	The input of pulse signal connects to the upper controller and supports open collector, voltage, line drive and push-pull input type, the maximum is 500K.	Maximum frequency: 500KP/Sec
	$\overline{A2}$ 、 $\overline{B2}$		
Output	AO、BO、ZO	The line-drive dividing frequency output is 1 ~ 255 times dividing frequency.	Maximum output voltage: 5V Maximum current: 50mA Maximum frequency: 500KP/Sec
	$\overline{AO}$ 、 $\overline{BO}$ 、 $\overline{ZO}$		
Power	R1-R2	Resolver power output	7Vrms, 10KHz

◆ Ordering code:

NO.	Type	Name	Ordering Code
1	PG302L	PG302L card	SNKPG302L

Note: In order to install the expansion card, you need to purchase the expansion card installation accessory (SNKCMK301) at the same time.

### 7.5.4 Keypad

➤ PU302 appearance

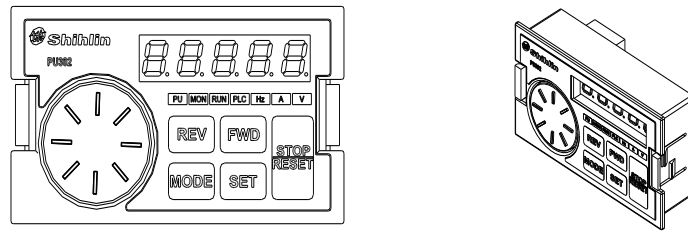

◆ Ordering code:

NO.	Type	Name	Ordering Code
1	PU302	LED keypad	SNKPU302

◆ Appearance and dimensions

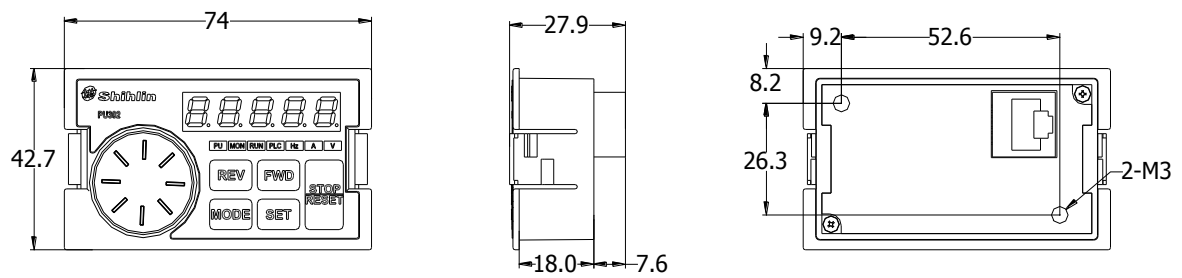

◆ Recommended screw installation size

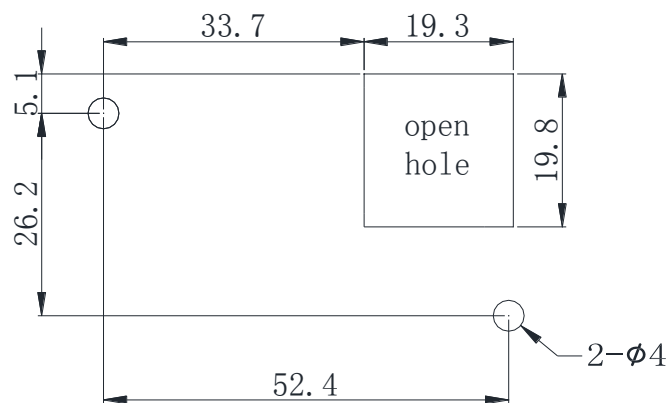

◆ Recommended buckle installation size

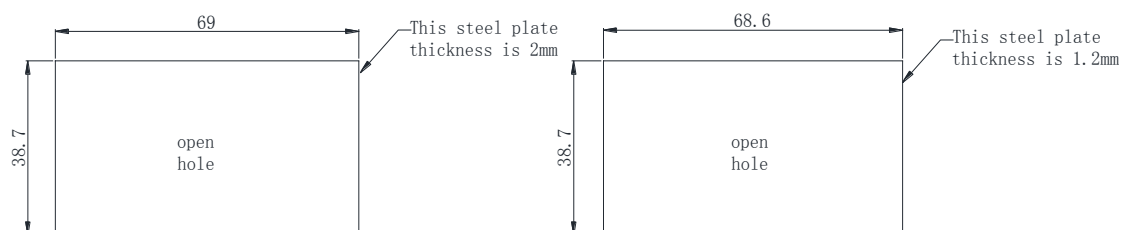

◆ Snap mounting

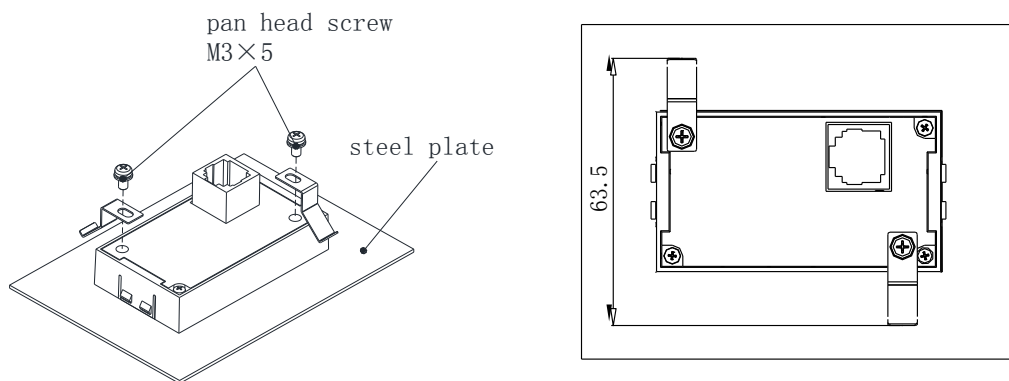

\*Allowable error:±0.15mm

\*If customer cutout accuracy cannot meet the allowable error, please purchase SMK301 (Snap Mounting Kit) for installation.

7.5.5 Data transmission line

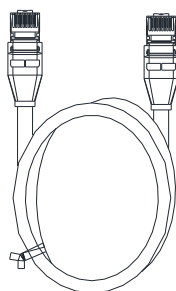

◆ Ordering code:

NO.	Type	Name	Ordering Code
1	CBL1R5GTN2	The data transmission line (1.5 m)	SNKCBL1R5GTN2
2	CBL03GTN2	The data transmission line (3 m)	SNKCBL03GTN2
3	CBL05GTN2	The data transmission line (5 m)	SNKCBL05GTN2
4	CBL10GTN2	The data transmission line (10 m)	SNKCBL10GTN2

7.5.6 BKU Brake unit

➤ BKU

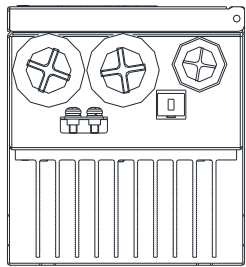
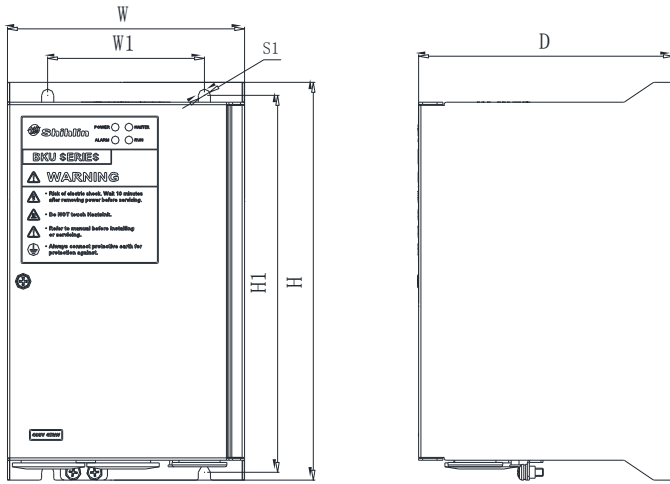

Terminal		Name	Function instruction	Terminal specification	H1	D	S1
A	BKU-020-37K	121	80	200	189.5	130	6.4
	BKU-040-45K						

◆ Ordering code:

NO.	Type	Name	Ordering Code
1	BKU-020-37K	200V 37KW Brake unit	SNKBKU-020-37K
4	BKU-040-45K	400V 45KW Brake unit	SNKBKU-040-45K

7.5.7 Expansion card mounting base

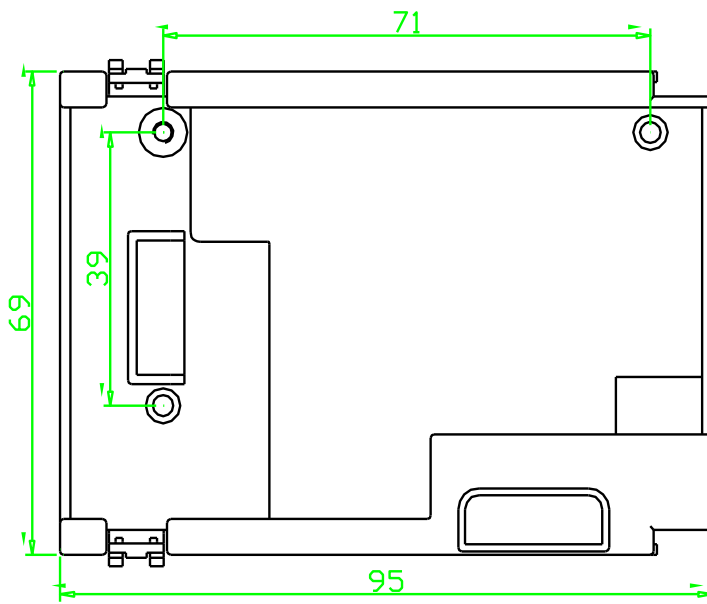

◆ Ordering code:

NO.	Type	Name	Ordering Code
1	CMK301	Expansion card mounting base	SNKCMK301

## 7.6 Appendix 6 European Specification Compatibility Description

### **This inverter qualifies the CE label. Specifications:**

#### **Low Voltage Directive 0014/35/EC & Electromagnetic Compatibility Directive 2014/301/EC.**

##### 1. Electromagnetic compatibility command (EMC):

###### (1). EMC compatibility description:

For system integration, inverter is not a functionally independent device unit. It is usually a unit in the control box. It is combined with other devices to control a machine or equipment. Therefore, our company does not consider that all the EMC commands should be directly applied on the inverter. As a result, the CE label of this inverter is not extensible.

###### (2). Compatibility:

The inverter does not need to cover all the EMC commands. Yet, for certain machine equipment that needs to use EMC commands and the inverter, the machine has to be equipped with CE label. In addition, the company can provide the electromagnetic inspection data and operation manual that covers the required electromagnetic compatibility specifications for a quick and easy installation of the machine equipment of this inverter.

###### (3). Installation outline:

Please follow the following notes for installing the inverter:

\*Use a noise filter qualifying the EU standard to coordinate with the inverter.

\*The wire between the motor and the inverter has to be stored in shielded cable or metal tube. In addition, ground the motor terminal and the inverter terminal together. Please shorten the wire as much as possible.

\*Please put this inverter in a metal cabinet that is already grounded. It can prevent radiation interference.

\*The line-to-line noise filter at the power source terminal and the online magnetic iron core at the control row are used for suppressing noises.

All the signals and the EU-qualified filter specifications are described in details in the operation manual. Please contact your agent.

##### 2. Low-voltage command (LVD):

###### (1). Low-voltage command compatibility description:

This inverter is compatible with low-voltage commands.

###### (2). Compatibility:

Our company qualifies the low-voltage command specification.

###### (3). Description:

\*Do not rely on leakage protection only for preventing electric shocks. Grounding is required for the protection.

\*Ground each inverter individually (do not connect more than two (including two) ground cables).

\*Please use non-fuse switch and electromagnetic contactor that qualify EN or IEC specifications.

\*Please use the inverter under an environment of over-voltage level-3 condition with contamination level 2 or better.

\*For the style and dimensions of the input- and output-end of the inverter cable, please refer to the specifications listed in the operation manual.

## EU-Declaration of Conformity

**Herewith we(manufacture):**

<b>Name:</b>	<b>SUZHOU SHIHLIN ELECTRIC &amp; ENGINEERING CO., LTD.</b>
<b>Address:</b>	<b>NO.88, Guangdong St., Suzhou New District, Jiangsu, China.</b>

Declare that the following Appliance complies with the appropriate basic safety and health requirements of the EU Directives(see Item 4) and the relevant Union harmonisation legislation based on its design and type, as brought into circulation by us.

The object of the declaration is identification of electrical equipment allowing traceability.

The declaration relates exclusively to Shihlin products in the state in which it was placed on the market, and excludes components which are added and/or operations carried out subsequently by the final user.

This declaration of conformity is issued under the sole responsibility of the manufacture.

1	<b>Product name:</b>	<b>Inverter</b>
2	<b>Model/Type:</b>	<b>SE3 Series (Reference the attached list of catalogue numbers)</b>
3	<b>Batch or Serial number:</b>	<b>Reference the attached list of catalogue numbers</b>
4	<b>Application EU Directives:</b>	<b>Low voltage Directive 2014/35/EU EMC directive 2014/30/EU RoHS Directive 2011/65/EU, (EU)2015/863</b>
5	<b>Used harmonized Standards:</b>	<b>LVD: EN61800-5-1:2007/A11:2021 EMC: EN61800-3:2018</b>
6	<b>Signed for and on behalf of:</b>	<b>SUZHOU SHIHLIN ELECTRIC &amp; ENGINEERING CO., LTD.</b>
7	<b>Print Name, Function(Title of Signature )</b>	<b>Anne Yang, Director</b>
8	<b>Signature</b>	<i>Anne Yang</i>
9	<b>Place and date of issue</b>	<b>Suzhou of China, 2021.6.30</b>
<p><b>Manufacturer Statement:</b></p> <p>✓ We shall give the manufacturer full name and address, registered trade name or registered trade mark, and true Batch/series no., "xxxx-xxxx" in the EU declaration and on the product(marking plate), or where that is not possible, on its packaging or in a document accompanying the product.</p> <p>✓ We shall keep the technical documentation referred to in Annex III and the EU declaration of conformity for 10 years after the electrical equipment has been placed on the market.</p>		

**Catalogue numbers:**

<b>Series name</b>	<b>Model name</b>	<b>Serial number<sup>1</sup></b>
<b>SE3 Series</b>	SE3-043-0.4K-xy, SE3-043-0.75K-xy, SE3-043-1.5K-xy, SE3-043-2.2K-xy, SE3-043-3.7K-xy, SE3-043-5.5K-xy, SE3-043-7.5K-xy, SE3-043-11K-xy, SE3-043-15K-xy, SE3-043-18.5K-xy, SE3-043-22K-xy, SE3-023-0.4K-xy, SE3-023-0.75K-xy, SE3-023-1.5K-xy, SE3-023-2.2K-xy, SE3-023-3.7K-xy, SE3-023-5.5K-xy, SE3-023-7.5K-xy, SE3-023-11K-xy, SE3-023-15K-xy, SE3-021-0.4K-xy, SE3-021-0.75K-xy, SE3-021-1.5K-xy, SE3-021-2.2K-xy	/

- 1) If no series number is given, then all series are covered
- 2) xy: denote any alphanumeric suffix



## 8. REVISION RECORD

Published Date	Edition of the Manual	Revision Content
2017.10	V1.00	First Edition
2018.1	V1.01	Modification : 1. 2.1 Nameplate instruction 2. Partial parameters of the factory
2018.2	V1.02	Add : CE declare  Modification : Frame A size
2018.7	V1.03	Modification : 1.6.3 Retrograde Brake Resistor Add : 7.6 Appendix 6 WEEE LOGO
2019.5	V1.04	Modification : Partial parameter modification Add : 7.3 Appendix 3 Warning Code List
2020.05	V1.05	Add : 3.1 INVERTER INTRODUCTION : Rated input current 7.1.2 Arrange by function group Modification : 3.2 Output frequency range : 0~599Hz 7.2 Appendix 2 Alarm code list
2021.03	V1.06	Add : 5.2.13 Remote frequency acceleration/deceleration time selection 5.9.13 PID feedback disconnection detection function 5.10.11 Encoder installation transmission ratio 5.12.11 PM motor id given low-pass filter time constant 5.14.4 Acceleration torque boost Modification : Improve and optimize the content of some parameter descriptions

Version: V1.06