

# KSR & KSC Series

## Accessory

### Heatsink

KHS 015 - □

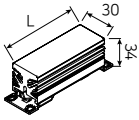

□ : 080 / 100 / 120

KHS 030 - □

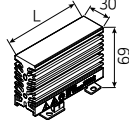

□ : 080 / 100 / 120

KHS 045 - □

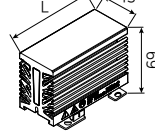

□ : 080 / 100 / 120

KHS 080 - □

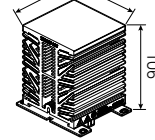

□ : 080 / 100 / 120

KHS 120 - □

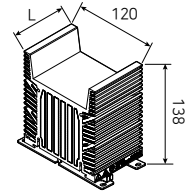

□ : 080 / 100 / 120 / 130

- Maximized heat-radiating surface area via innovative design
- Exclusive advanced Al alloy material for heat radiation
- Special thermal processing for high efficiency use
- Anti-corrosion anodizing surface treatment
- Easily removable structure of air blow fan
- Provision of multiple extended types
  - Optimal heat radiator selectable
  - For diverse environment
- In-house production
  - Stable quality and supply
  - Quick response to special products

### Fan

unit : mm



12 VDC

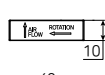

12 / 24 VDC

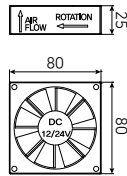

12 / 24VDC (PA6)  
100 / 220VAC 50 ~ 60Hz (AL alloy)

- Easily removable structure
- High-performance ball-bearing type
  - Low noise
  - Prolonged life
- Doubled device life

### Technical Data

Input Current & Input Impedance

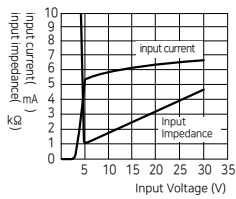

Heatsink Type & Heatsink + Fan Type

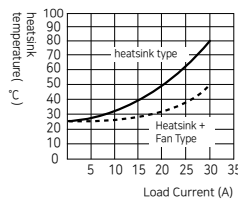

⇒ (ambient temperature 25°C)  
vertical mounting

Ambient Temperature-Load Current

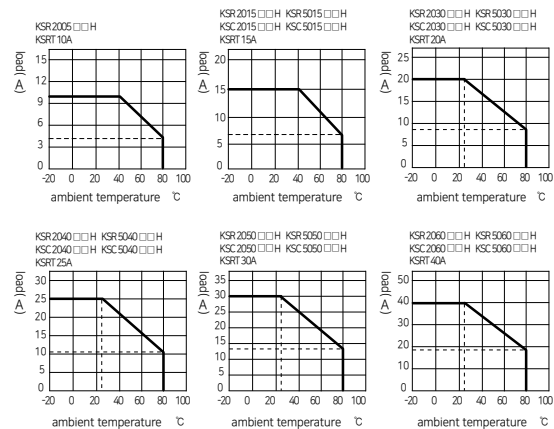

#### Caution

- The radiator fan reduces the radiator temperature by up to 35 ~ 40 % (ambient temperature of 25°C / vertical mounting)
- In the design process, note that the load current characteristic worsens with the increase in the ambient temperature.
- With the high-voltage type, design the system at 80 % of the rating or less.
- The device life is prolonged when the temperature decreases.

## KSR & KSC Series

### Heatsink Type

Vertical Mounting

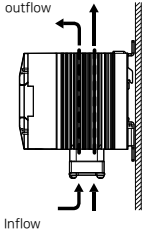

Horizontal Mounting

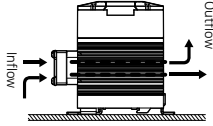

Panel Mounting

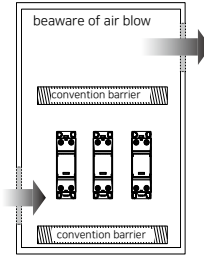

- Direct the fan in the lower direction for vertical installation, and in the air inlet direction for horizontal direction.
- If the horizontally mounted device does not have an integrated fan, use it at 50% of the rated current or less.
- Pay attention to the increase in the ambient temperature from the heating of the device. Especially when mounting the device in the panel, be sure to install a fan for sufficient ventilation.
- Remove any obstacles for air flow around the air inlet and outlet.

### General Type

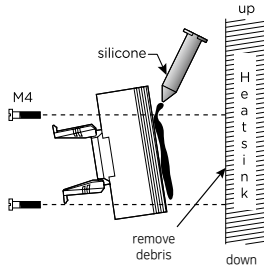

※ silicone grease to provide.

- Be sure to attach the normal KSR/KSC to the heatsink with a high heat radiation performance.
- Do not attach them to low-thermal-conductivity materials, including glass, wood and plastic.
  - Otherwise, it may cause damage to the device and fire.
- Remove the foreign matters from the mounting surface of the radiator or heatsink, and apply silicone grease for heat radiation to the surface.
- The heat radiation effect greatly depends on the mounting condition and silicone grease application. Poor treatment may cause damage to the device.
- The heat radiation effect is ensured when the device and radiator are vertically mounted with good ventilation.
- Tighten the fixing bolts at the specified torque for fixing the device to the radiator.

☞ KSR, KSC fixing bolt M4-tightening torque 1.2 N·m

### KSR Mounting Distance

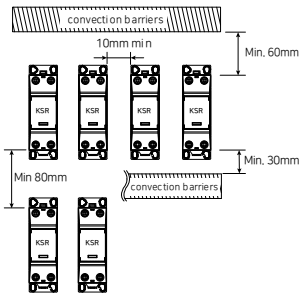

### KSC Mounting Distance

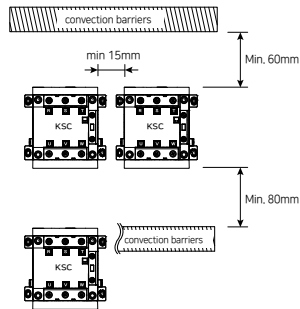

- The heat radiation effect decreases when there is not much room. Limit the load current below the rating.
- Install the device as far as possible from a heating unit, if there is any.
- Allow the longest distance possible between the device and other unit.

### EMC Wiring

#### KSR Type

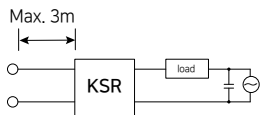

- Connect the film condenser at the Power in Parallel
- Limit the input wire length Maximum 3 m

#### KSC Type

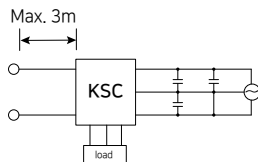

### Time Loss

Note that low voltage and current of the load increases time loss. Check if any problem exists.

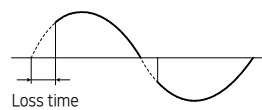

# KSR & KSC Series

## Accessory

### Terminal

- When using crimp terminals, refer to the terminal specifications for terminal part spaces.

#### KSR Input Terminal

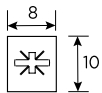

M3.5

#### KSR Load Terminal

5 / 15 / 30A Type

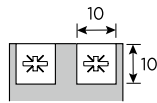

M4

40 / 50 / 60 / 80A Type

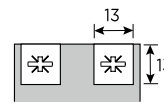

M6

#### KSC Input Terminal

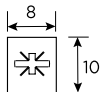

M3.5

#### KSC Load Terminal

5 / 15 / 30A Type

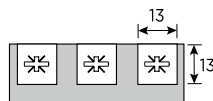

M4

40 / 50 / 60 / 80A Type

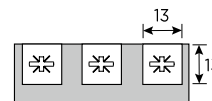

M6

### Rated Terminal specification

unit : mm

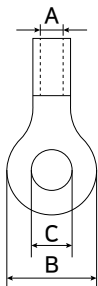

Model	Bolt	A (mm)	B (mm)	C (mm)	Terminal	Wire Ø	Torque Max N·m	
Load	KSR 5 / 15 / 30A	M4.0	3.0	8.3	4.3	3.5-4.0	2.0	1.2
	KSR 40 / 50 / 60A	M6.0	5.8	12.0	6.4	4.0-6.0	4.2	2.5
	KSR 80A	M6.0	5.8	12.0	6.4	4.0-6.0	5.3	2.5
	KSC 15 / 30A	M4.0	3.0	8.3	4.3	3.5-4.0	2.0	1.2
	KSC 40 / 50 / 60A	M6.0	5.8	12.0	6.4	4.0-6.0	4.2	2.5
	KSC 80A	M6.0	5.8	12.0	6.4	4.0-6.0	5.3	2.5
Input	all	M3.5	2.3	6.6	3.7	2.0-3.5	2.0	0.8

☞ input terminal Color : ⊕ red, ⊖ black

- Be sure to conduct wiring only after switching off the power.
- Select the wire size according to the current.
- Tighten screws firmly at the specified torques.
- Applying an excessive torque may cause the screw to fail. Pay attention especially when using an electric driver.
- The screw at the output terminal must not be loosened. Abnormal heating at the terminal may cause fire.
- After wiring, be sure to lock the terminal safety cover in the closed position to prevent an electric shock or a short circuit.

# SSR EOCR

K-EOCR 50



## KSR Current Monitoring Detector

- SSR load overcurrent and disconnection alarm
- Overcurrent level adjustment function
- NPN TR external signal output
- Status LED
- Din-rail mounting
- Applied to single-phase and three-phase SSR

## General Specification

Input Ratings (Ambient Temperature 25°C)	Rated Control Voltage	12 ~ 24VDC	General Ratings	Insulation Resistance	100MΩ min.(at 500VDC)
	Control Voltage Range	9.6 ~ 30VDC		Dielectric Strength	2,500VAC, 50/60Hz
	Input Current	15mA		Vibration Resistance	10 ~ 55 ~ 10Hz Side Vibration 0.35mm (Both Vibration 0.7mm)
Load Ratings	Rated Load Voltage	100 ~ 240VAC (50/60Hz)	Shock Resistance	294m/s <sup>2</sup>	
	Maximum Switching Current	50A		Storage Temperature	-30 ~ 70°C (with no icing or condensing)
	Minimum Switching Current	3A		Ambient Temperature	-20 ~ 60°C (with no icing or condensing)
Alarm Ratings	Off-State Collector Dielectric Voltage	Maximum 30VDC	Ambient Humidity	45 ~ 85%RH (no condensing)	
	Maximum Switching Current	0.1A			
	Output Type	NPN Open Collector			

## Dimension

unit : mm

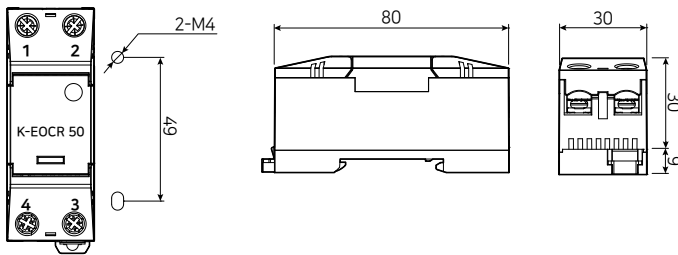

	Load	Input
Terminal	3.5 - 4.0	2.0 - 3.5
Bolt	M4.0	M3.5
Torque Max / N·m	1.2	0.8

## Wiring

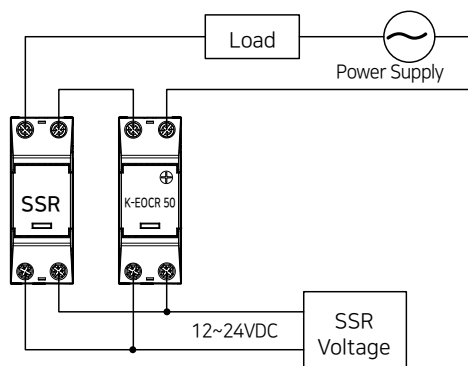

### Caution

- Use the same power supply for KSR / KSC and K-EOCR 50 input. Otherwise, the short circuit monitoring function does not work.
- The input voltage must be within the range of rating, without fluctuation. Otherwise, the monitoring level (load current value) set by the user may change and operating errors may occur.
- The alarm output is NPN Open Collector output. Use the product at 0.1A/30VDC or less.

Wiring Diagram

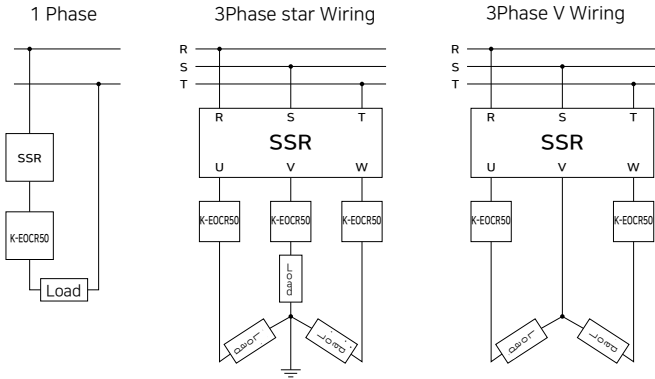

외부 신호 활용 예시

PLC 입력 배선의 예

표시등 배선의 예

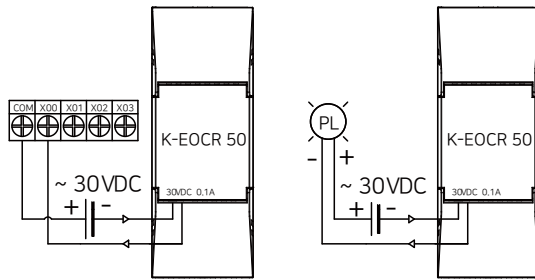

과전류 레벨 설정 요령

1. SSR, K-EOCR 50, 부하를 포함한 실제 회로를 구성 합니다.
2. 정격부하 상태에서 과전류 레벨 다이얼을 반 시계 방향으로 조정하여 표시등이 적색으로 표시되는 것을 확인 합니다.
3. 이때 다이얼을 다시 시계 방향으로 조정하여 표시등이 녹색으로 바뀌는 시점에 정지하여 설정을 완료 합니다.
4. 이 설정 상태에서 부하 운용 중 과전류가 발생하면 표시등이 적색으로 전환 되고 외부 출력이 발생 합니다.

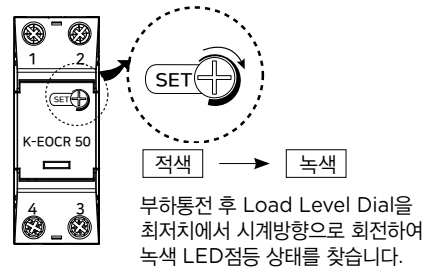

동작 및 표시

