

Safety Cover Terminal Block C Type

KTB Series

Part Number Description

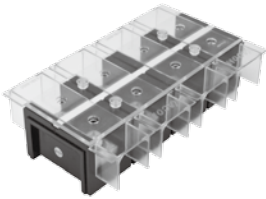

KTB1 - **2** **3** - C (Terminal block safety cover integral type)

1 Description	1 : Power Distribution Block				
2 Rated Current	010 : 10A	020 : 20A	030 : 30A		
	300 : 300A	400 : 400A	500 : 500A	600 : 600A	
3 Number of Poles	03 : 3Pole	04 : 4Pole	06 : 6Pole	10 : 10Pole	
	12 : 12Pole	15 : 15Pole	20 : 20Pole	20 : 20Pole	

※ The number of poles is Power Distribution Block type only.

General Specification

Description	KTB1-010 ~ 020 Series(10A, 20A)	KTB1-30 ~ 100 Series(30A ~ 100A)	KTB1-150 ~ 600 Series(150A ~ 600A)	
Rated Voltage	Max. 600VAC			
Insulation Resistance	1,000MΩ min.(at 500VDC)			
Dielectric Strength	2,500VAC per 1 minute			
Material	Body	Fire resistant transparent PC(HB), Black	Fire resistant phenolic resin(V0), Black	Fire resistant phenolic resin(HB), Black
	Terminal Block Cover	Fire resistant transparent PC(HB), Clear		
	Terminal Block Safety Cover	Fire resistant transparent PC(V2), Clear		
	Terminal	1st grade brass		
	Name Plate	PVC (pearl white)		

⚠ Cautionary temperature in use : -20 ~ 60°C

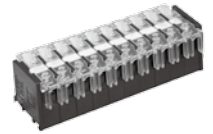

Part Number Description

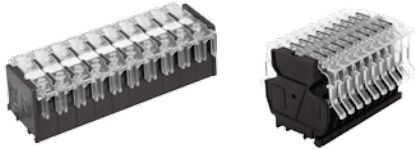

KTB1 - **2** - C (Terminal block)

1 Description	2 : Modular Terminal Block	3 : Two Level Modular terminal block		
2 Rated Current	010 : 10A 060 : 60A	015 : 15A 100 : 100A	025 : 25A	035 : 35A

General Specification

Description		KTB2 Series(10A ~ 100A)		
Rated Voltage		Max. 600VAC		
Insulation Resistance		1,000MΩ min.(at 500VDC)		
Dielectric Strength		2,500VAC per 1 minute		
Material	Body	Flame retardant PC (HB)		
	Safety Cover	Fire resistant transparent PC(V2), Clear		
Separator		A10 : for 010 A60 : for 060	A25 : for 015, 025 A100 : for 100	A35 : for 035
Accessory	Cover	CVA : for 010	CVB : for 015 ~ 035	CVC : for 060 ~ 100
	Name Plate	PA : for KTB2-010	PB : for KTB2-015 or later	
	Stopper	STA : 15mm	STB : 35mm	STC : 35mm (Plastic)
	Channel	CHA : 10A 15mm 1m CHB : 15A ~ 100A 35mm 1m CHC : 15A ~ 100A 35mm 1m, Cutting type		CHA-2M : 10A 15mm 2m CHB-2M : 15A ~ 100A 35mm 2m

☞ Cautionary temperature in use : -20 ~ 60°C

Description		KTB3-010(10A)	KTB3-015(15A)
Rated Voltage		Max. 600VAC	
Insulation Resistance		1,000MΩ min.(at 500VDC)	
Dielectric Strength		2,500VAC per 1 minute	
Material	Body	Fire resistant transparent PC(HB)	
	Safety Cover	Fire resistant transparent PC(V2), Clear	
Separator		KTB3-A10	KTB3-A15
Accessory	Cover	KTB2-CVA	KTB2-CVB
	Name Plate	KTB2-PA	KTB2-PB
	Stopper	KTB2-STA : 15mm	KTB2-STB : 35mm
	Channel	KTB2-CHA	KTB2-CHB, KTB2-CHC



☞ Cautionary temperature in use : -20 ~ 60°C

☞ Heat rating (B) 130 °C (KS C IEC60085)



Safety Cover Terminal Block C Type

KTB Series

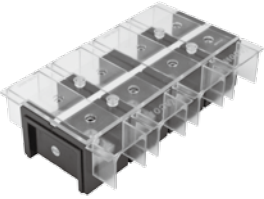
Product Selection

	Rated Current	Pole	Terminal Bolt	Order Code	Part		
					Terminal Block	Insulated wall cover	Fixed Bracket
	10A	3	M3.0	KTB1-01003-C	KTB1-01003	KTB1-010C	KTB1-BKT
		4		KTB1-01004-C	KTB1-01004		
		6		KTB1-01006-C	KTB1-01006		
		10		KTB1-01010-C	KTB1-01010		
	20A	3	M4.0	KTB1-02003-C	KTB1-02003	KTB1-020C	KTB1-BKT
		4		KTB1-02004-C	KTB1-02004		
		6		KTB1-02006-C	KTB1-02006		
		10		KTB1-02010-C	KTB1-02010		
		12		KTB1-02012-C	KTB1-02012		
		15		KTB1-02015-C	KTB1-02015		
30A	3	M4.0	KTB1-03003-C	KTB1-03003	KTB1-030C	KTB1-BKT	
	4		KTB1-03004-C	KTB1-03004			
	6		KTB1-03006-C	KTB1-03006			
	10		KTB1-03010-C	KTB1-03010			
	60A	3	M6.0	KTB1-06003-C	KTB1-06003	KTB1-060C (With top hole cover)	KTB1-CAP (With dedicated hook)
		4		KTB1-06004-C	KTB1-06004		
	100A	3	M7.0	KTB1-10003-C	KTB1-10003	KTB1-100C (With top hole cover)	KTB1-CAP (With dedicated hook)
		4		KTB1-10004-C	KTB1-10004		
	150A	3	M8.0	KTB1-15003-C	KTB1-15003	KTB1-150C (With top hole cover)	KTB1-CAP (With dedicated hook)
		4		KTB1-15004-C	KTB1-15004		
	200A	3	M8.0	KTB1-20003-C	KTB1-20003	KTB1-200C (With top hole cover)	KTB1-CAP (With dedicated hook)
		4		KTB1-20004-C	KTB1-20004		
	300A	3	M10.0	KTB1-30003-C	KTB1-30003	KTB1-400C (With top hole cover)	KTB1-CAP
		4		KTB1-30004-C	KTB1-30004		
	400A	3	M10.0	KTB1-40003-C	KTB1-40003	KTB1-400C (With top hole cover)	KTB1-CAP
		4		KTB1-40004-C	KTB1-40004		
	500A	3	M12.0	KTB1-50003-C	KTB1-50003	KTB1-600C (With top hole cover)	KTB1-CAP
		4		KTB1-50004-C	KTB1-50004		
	600A	3	M12.0	KTB1-60003-C	KTB1-60003	KTB1-600C (With top hole cover)	KTB1-CAP
		4		KTB1-60004-C	KTB1-60004		

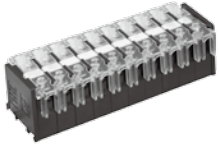
Product Selection

	Rated Current	Pole	Terminal Bolt	Order Code	Part		
					Terminal Block	Insulated wall cover	Fixed Bracket
	10A	M3.0	KTB2-010-C	KTB2-01010C	KTB2-S1010	KTB2-S1010□	KTB2-A10
	15A	M3.5	KTB2-015-C	KTB2-01510C	KTB2-S1510	KTB2-S1510□	KTB2-A25
	25A	M4.0	KTB2-025-C	KTB2-02510C	KTB2-S2510	KTB2-S2510□	KTB2-A25
	35A	M4.0	KTB2-035-C	KTB2-03510C	KTB2-S3510	KTB2-S3510□	KTB2-A35
	60A	M6.0	KTB2-060-C	KTB2-06010C	-	-	KTB2-A60
	100A	M6.0	KTB2-100-C	KTB2-10004C	-	-	KTB2-A100
	10A	M3.0	KTB3-010-C	KTB3-01010C	KTB3-S1010	KTB3-S1010□	KTB3-A10
	15A	M3.5	KTB3-015-C	KTB3-01510C	KTB3-S1510	KTB3-S1510□	KTB3-A15

Safety Cover Terminal Block C Type

KTB Series

Accessory

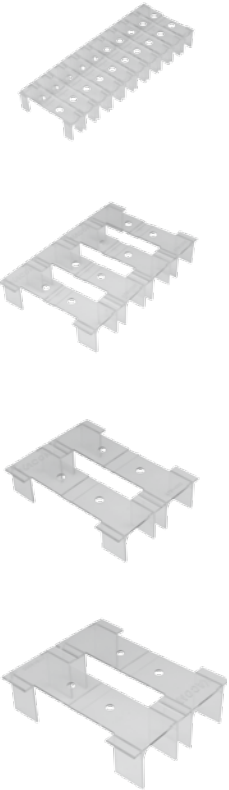
Description	Part Number	Pole	Applicable terminal block	
 <p>Safety Cover C Type ※ Flame retardant PC (V2)</p>	KTB1-010C	10	KTB1-01003 KTB1-01004 KTB1-01006 KTB1-01010	
	KTB1-020C	10	KTB1-02003 KTB1-02004 KTB1-02006 KTB1-02010 KTB1-02012 KTB1-02015 KTB1-02020	
	KTB1-030C	10	KTB1-03003 KTB1-03004 KTB1-03006 KTB1-03010	
	KTB1-060C	4	KTB1-06003 KTB1-06004	
	KTB1-100C	4	KTB1-10003 KTB1-10004	
	KTB1-150C	4	KTB1-15003 KTB1-15004	
	KTB1-200C	4	KTB1-20003 KTB1-20004	
	KTB1-400C		2	KTB1-30003 KTB1-30004
			2	KTB1-40003 KTB1-40004
	KTB1-600C		2	KTB1-50003 KTB1-50004
2			KTB1-60003 KTB1-60004	









Accessory

	Description	Part Number	Pole	Applicable terminal block
	Safety Cover C Type ※ Flame retardant (V2)	KTB2-01010C	10	KTB2-010
		KTB2-01510C	10	KTB2-015
		KTB2-02510C	10	KTB2-025
		KTB2-03510C	10	KTB2-035
		KTB2-06010C	10	KTB2-060
		KTB2-10004C	4	KTB2-100
	Safety Cover C Type ※ Flame retardant (V2)	KTB3-01010C	10	KTB3-010
		KTB3-01510C	10	KTB3-015
	Separator	KTB2-A10 KTB2-A25 KTB2-A30 KTB2-A60 KTB2-A100	-	KTB2-010 KTB2-015, KTB2-025 KTB2-035 KTB2-060 KTB2-100
	Separator	KTB3-A10 KTB3-A15	-	KTB3-010 KTB3-015

Safety Cover Terminal Block C Type

KTB Series

Accessory

	Description	Part Number	Applicable item
	Fixed Bracket ※ Flame retardant (V2)	KTB1-BKT	KTB1-010C, KTB1-020C, KTB1-030C
	Fixed Cap ※ Flame retardant (V2)	KTB1-CAP	KTB1-060C, KTB1-100C, KTB1-150C, KTB1-200C, KTB1-400C, KTB1-600C
	Stopper	KTB2-STA (15mm용)	KTB2-CHA
	Stopper	KTB2-STB (35mm용)	KTB2-CHB, KTB2-CHC
	Stopper	KTB2-STC (35mm용 / 플라스틱)	KTB2-CHB, KTB2-CHC
	15mm Channel	KTB2-CHA (기본 1M) KTB2-CHA-2M	KTB2-010 / KTB3-010
	35mm Channel	KTB2-CHB (기본 1M) KTB2-CHB-2M	KTB2-015 ~ 100 / KTB3-015
	35mm Channel (Cutting type)	KTB2-CHC (기본 1M) KTB2-CHC-2M	KTB2-015 ~ 100 / KTB3-015
	Short Bar (only safety cover type) ※ color : B-Blue, K-Black, R-Red, Y-Yellow	KTB2-S1010 KTB2-S1510 KTB2-S2510 KTB2-S3510 KTB3-S1010 KTB3-S1510	KTB2-010C KTB2-015C KTB2-025C KTB2-035C KTB3-010C KTB3-015C

Dimension

unit : mm

Power Distribution Block

KTB1-01003-C

KTB1-01004-C

KTB1-01006-C

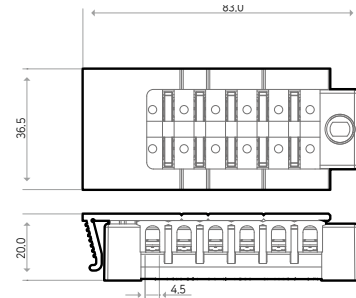
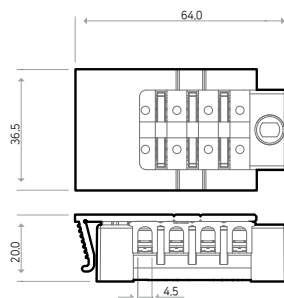
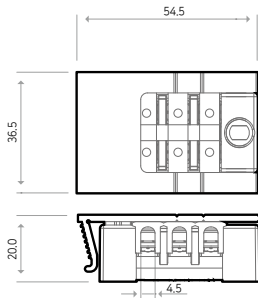

KTB1-01010-C

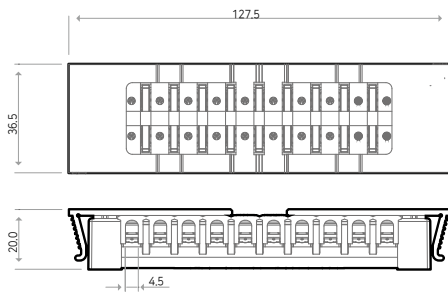

Safety Cover

KTB1-010C

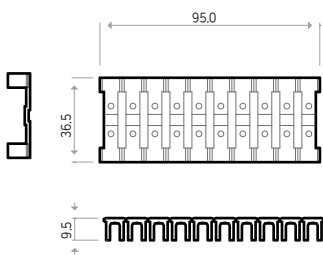

Safety Cover Terminal Block C Type

KTB Series

Dimension

unit : mm

Power Distribution Block

KTB1-02003-C

KTB1-02004-C

KTB1-02006-C

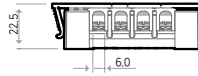
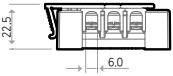
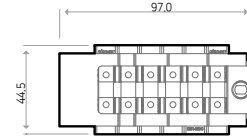
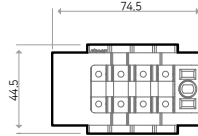
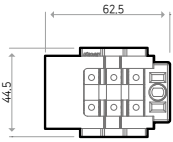

KTB1-02010-C

KTB1-02012-C

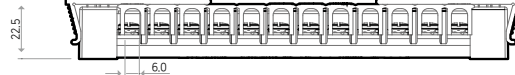
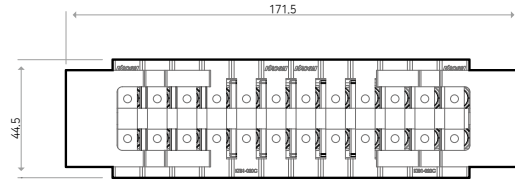
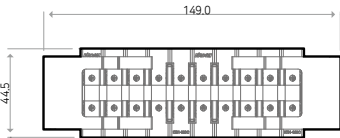

KTB1-02015-C

KTB1-02020-C

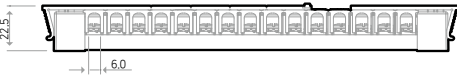
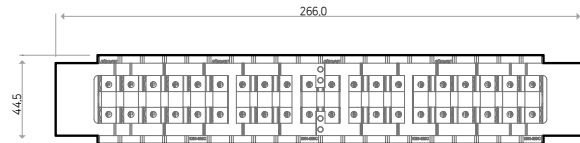
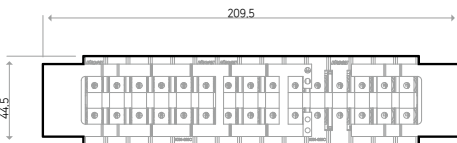

Safety Cover

KTB1-020C

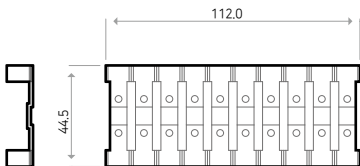

Rev. 2/14

Data subject may change without notice.

www.kacon.co.kr

Industrial Controls Catalog

IV - 45

KACON

Dimension

unit : mm

Power Distribution Block

KTB1-03003-C

KTB1-03004-C

KTB1-03006-C

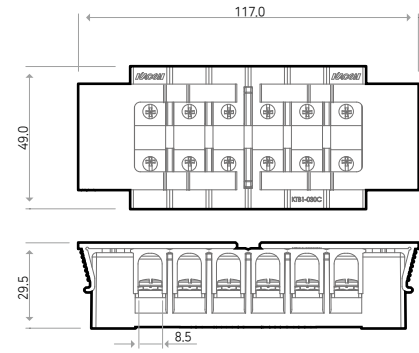
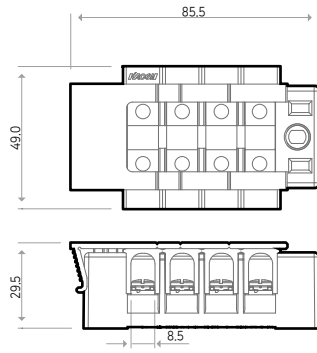
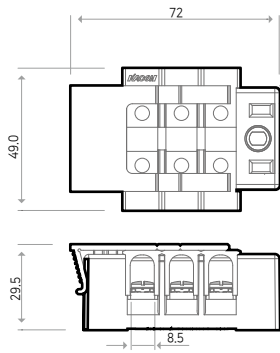

KTB1-03010-C

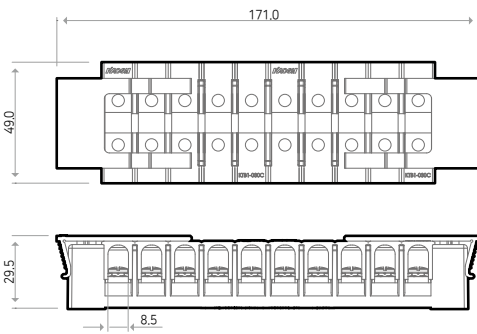

Safety Cover

KTB1-030C

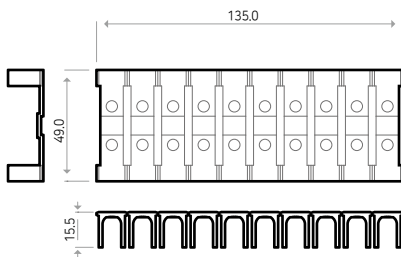

Safety Cover Terminal Block C Type

KTB Series

Dimension

unit : mm

Power Distribution Block

KTB1-06003-C

KTB1-06004-C

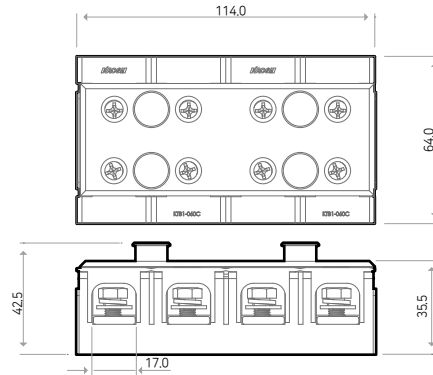
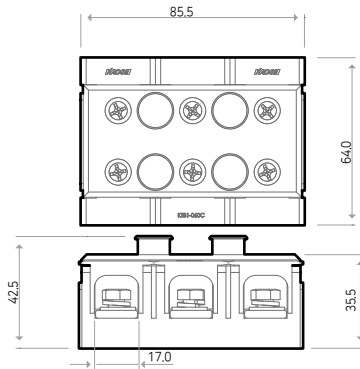

KTB1-10003-C

KTB1-10004-C

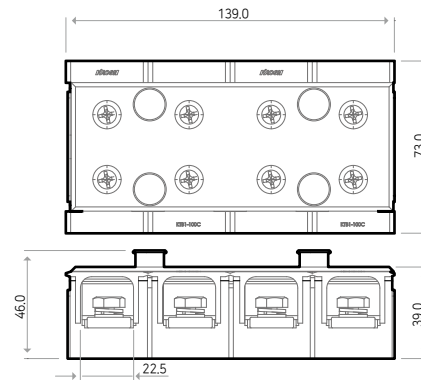
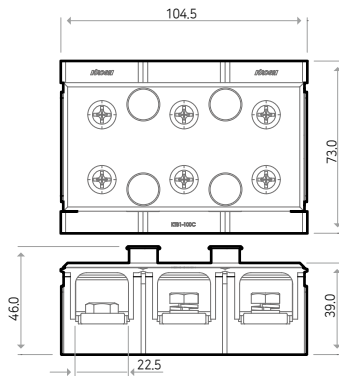

Safety Cover

KTB1-060C

KTB1-100C

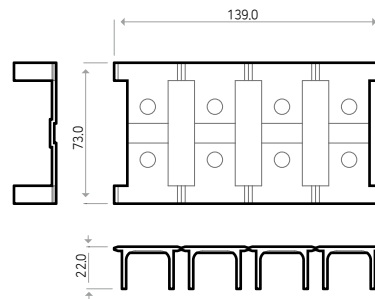
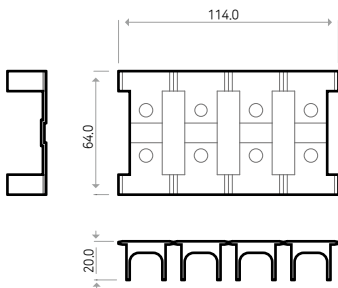

4 Part

소형회로
차단기

퓨즈 &
퓨즈홀더

씨지
보호기

음향
신호기

부저류

안전
단자대

고정식
조립식
단자대

시험
단자대

조립식
커먼
단자대

태양광
시스템

집합
표시등

시그널
타워

히터

온습도
제어기기

수배전반용
조명등

케이블
그랜드

Dimension

unit : mm

Power Distribution Block

KTB1-15003-C

KTB1-15004-C

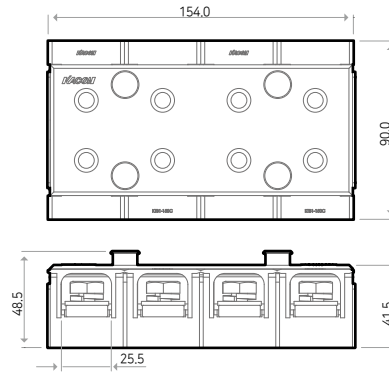
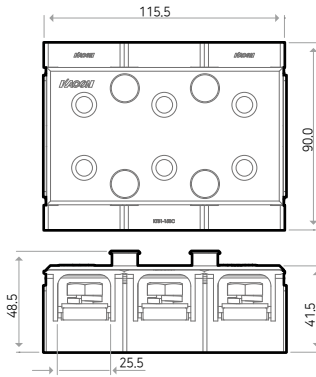

KTB1-20003-C

KTB1-20004-C

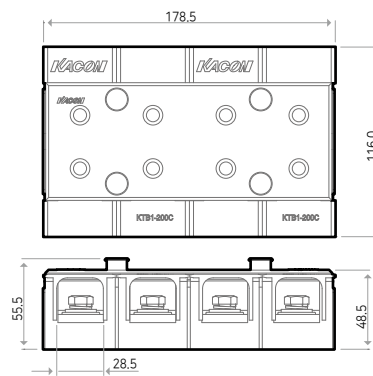
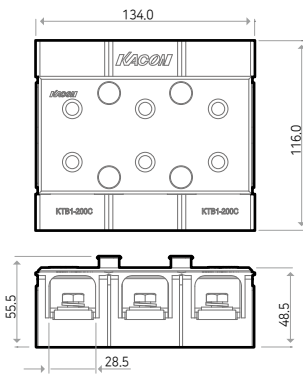

Safety Cover

KTB1-150C

KTB1-200C

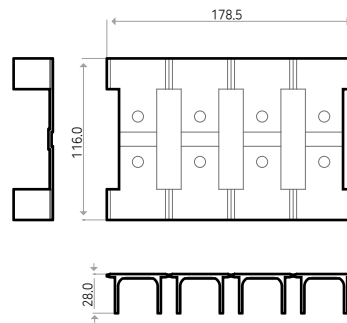
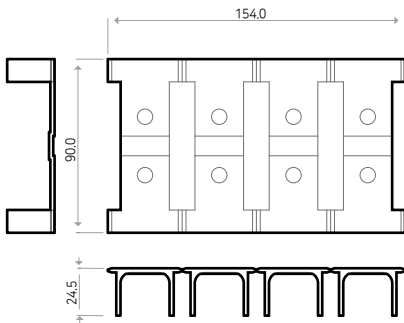

Safety Cover Terminal Block C Type

KTB Series

Dimension

unit : mm

Power Distribution Block

KTB1-30003-C

KTB1-30004-C

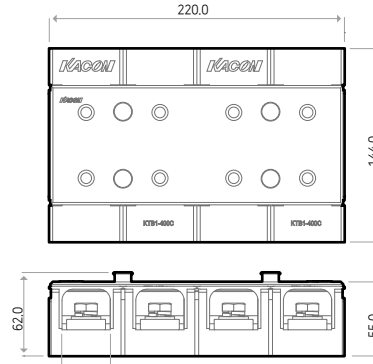
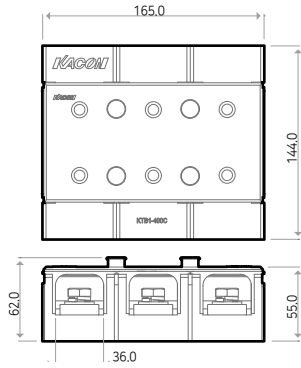

KTB1-40003-C

KTB1-40004-C

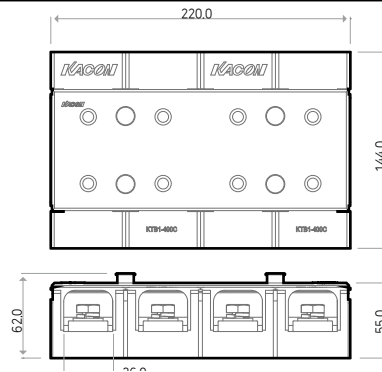
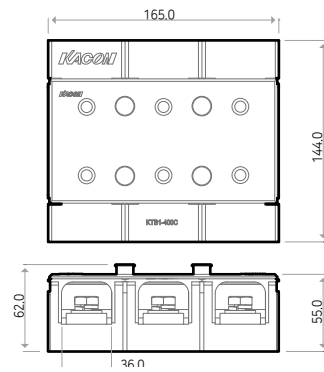

Safety Cover

KTB1-400C

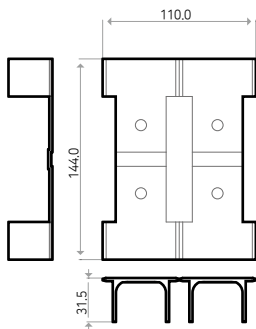

Dimension

unit : mm

Power Distribution Block

KTB1-50003-C

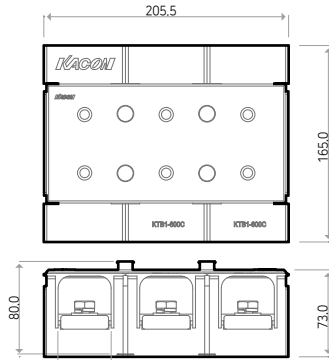

KTB1-50004-C

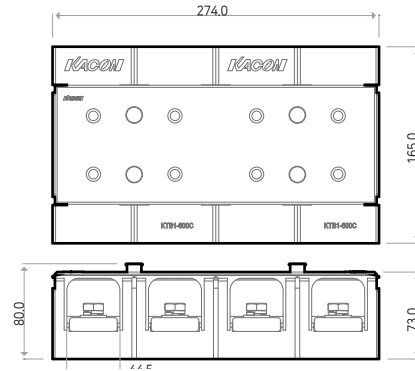

KTB1-60003-C

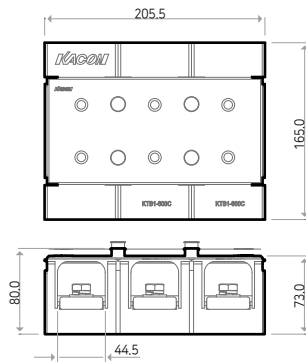

KTB1-60004-C

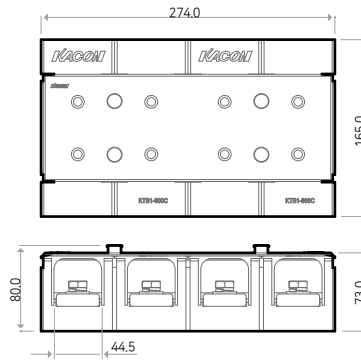

고정식 단자대 안전 보호 커버

KTB1-600C

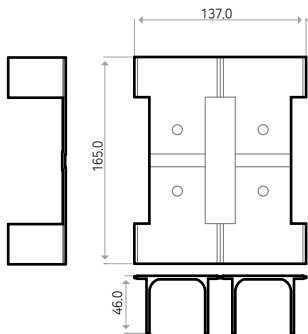

Safety Cover Terminal Block C Type

KTB Series

Dimension

unit : mm

Modular Terminal Block

KTB2-010-C

KTB2-015-C

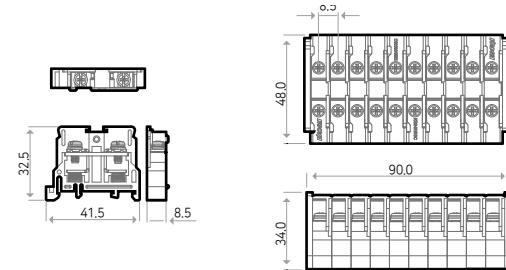
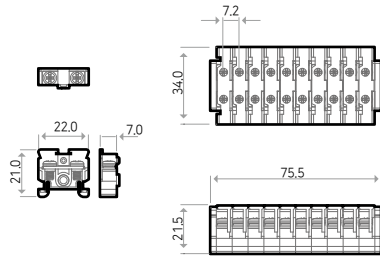

KTB2-025-C

KTB2-035-C

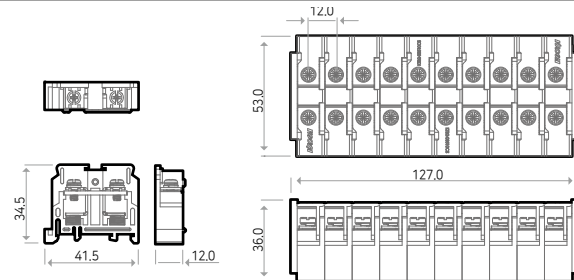
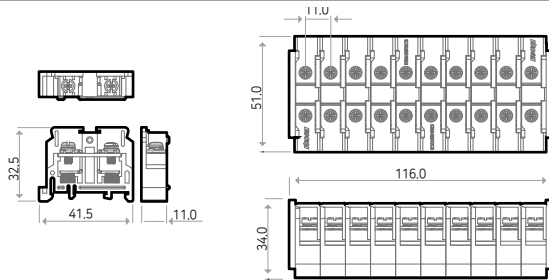

KTB2-060-C

KTB2-100-C

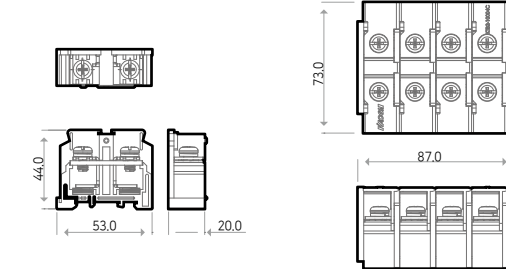
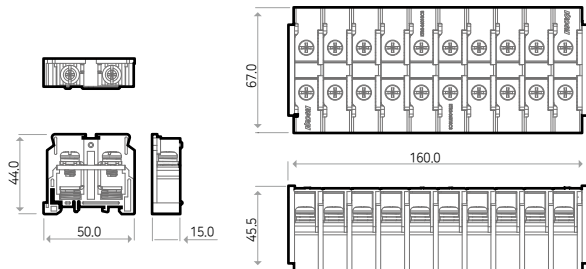

Two Level Modular terminal block

KTB3-010-C

KTB3-015-C

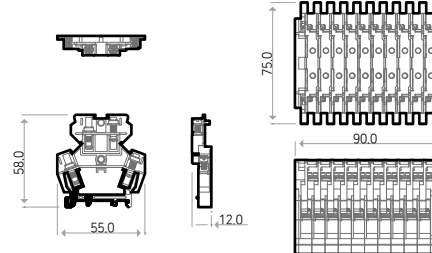
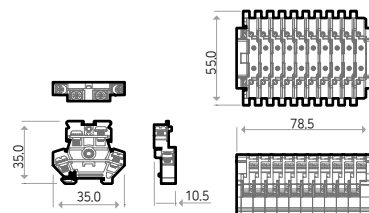

Dimension

unit : mm

Accessory

KTB1-C Type Safety Cover

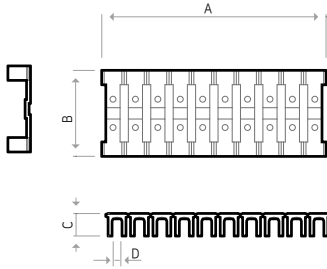

품명	A	B	C
KTB1-010C	95.0	36.5	9.5
KTB1-020C	112.0	44.5	11.5
KTB1-030C	135.0	49.0	15.5
KTB1-400C	110.0	144.0	31.5
KTB1-600C	137.0	165.0	46.0

KTB2-C Type Safety Cover

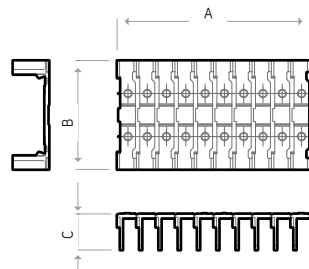

품명	A	B	C
KTB2-01010C	71.5	34.0	11.5
KTB2-01510C	85.0	48.0	16.0
KTB2-02510C	111.0	51.0	15.9
KTB2-03510C	121.5	53.0	16.3
KTB2-06010C	154.0	69.0	23.5

KTB2-10004C

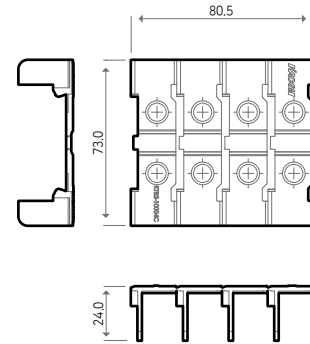

KTB3-01010C

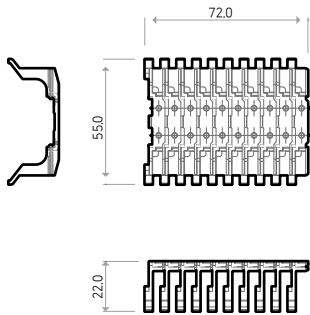

KTB3-01510C

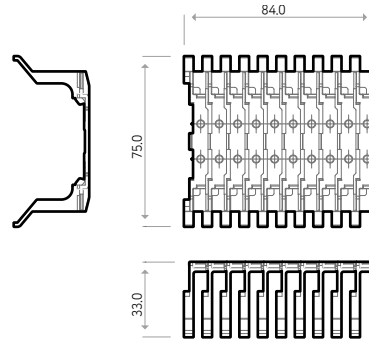

KTB1-BKT

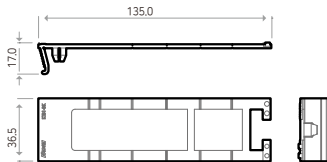

KTB1-CAP

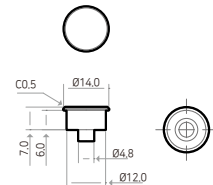

Safety Cover Terminal Block C Type

KTB Series

Dimension

unit : mm

Accessory

Short Bar

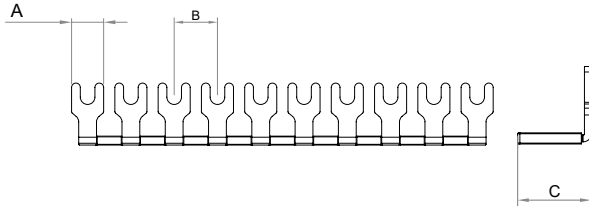

Part Number	A	B	C
KTB2-S1010	5	7.2	11
KTB2-S1510	6.5	8.5	12.5
KTB2-S2510	8.5	11.1	16
KTB2-S3510	9.0	12.2	16.5
KTB3-S1010	5.5	7	8
KTB3-S1510	6.3	8.15	10.5

Channel

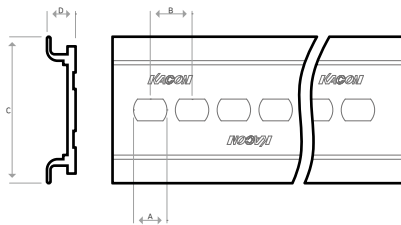

Part Number	A	B	C	D
KTB2-CHA	8.0	13.8	15.0	5.0
KTB2-CHB	8.0	14.0	35.0	7.0
KTB2-CHC	8.0	13.7	35.0	7.0

Stopper

KTB2-STA, KTB2-STB

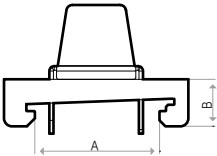
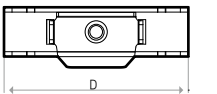

KTB2-STC

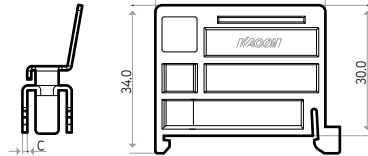
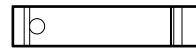

	KTB2-STA	KTB2-STB
A	13.2	31.5
B	8.5	12.0
C	1.2	1.2
D	21.0	46.5

Separator

KTB2-A Series

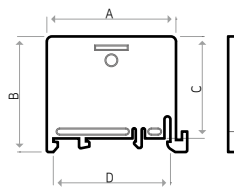

KTB3-A Series

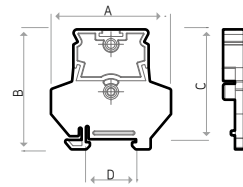

Part Number	A	B	C	D
KTB2-A10	22.0	21.0	17.5	15.0
KTB2-A25	38.0	34.0	30.0	35.0
KTB2-A35	38.0	36.0	32.0	35.0
KTB2-A60	48.0	45.0	41.0	35.0
KTB2-A100	51.0	45.0	41.0	35.0
KTB3-A10	35.0	35.0	32.0	15.0
KTB3-A15	55.0	58.0	54.0	35.0

Rev. 2/14

Data subject may change without notice.

www.kacon.co.kr

Industrial Controls Catalog

IV - 53

KACON

Assembly sequence

KTB1 Series

Assemble in order of terminal block, terminal block safety cover, and fixed accessory.

※ The name plate can be used both inside and outside the protective cover.

10 ~ 30A

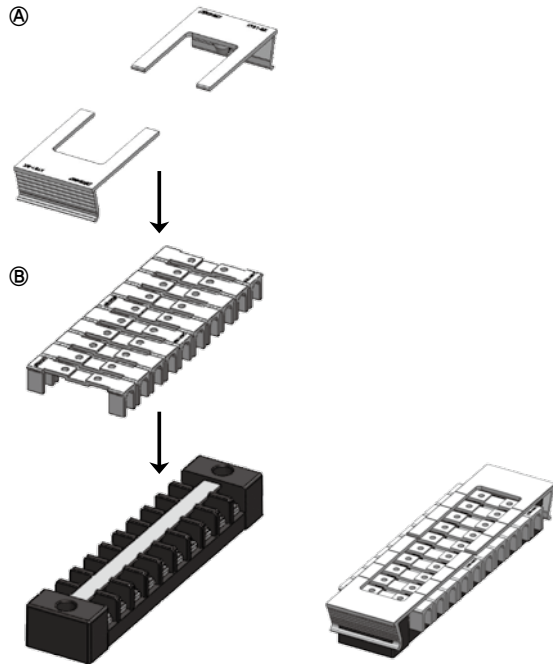

60 ~ 600A

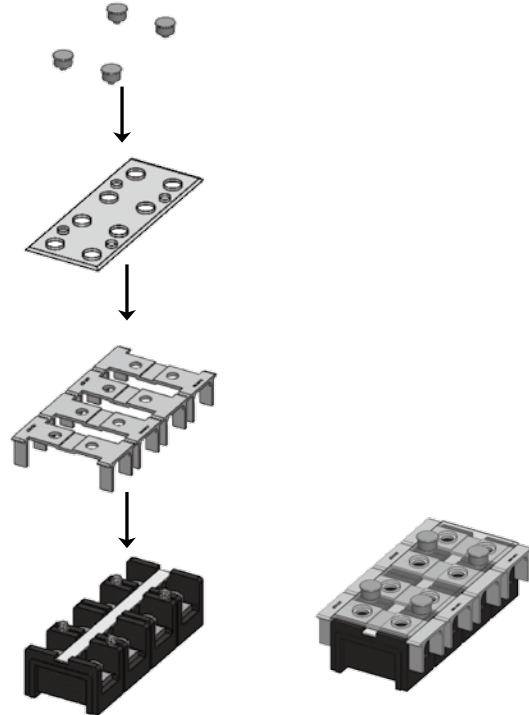

※ caution

- Ⓐ-1 - Check the direction of the fixing bracket when assembling.
 - Use one or two brackets depending on the number of used poles.

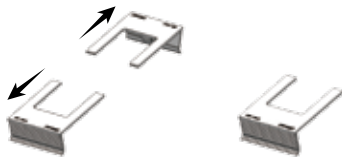

- Ⓐ-2 Cutting line is different for each ampere. Check and remove the cut line shown on the product.

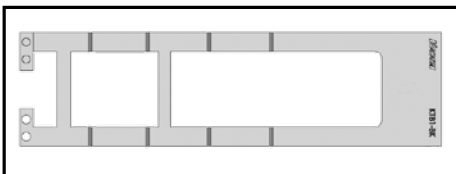

Safety Cover Terminal Block C Type

KTB Series

Assembly sequence

KTB2 Series

Assemble in order of terminal block and terminal block safety cover.

- ※ The name plate can be used both inside and outside the protective cover.
- ※※ Please check the mounting direction when attaching the protective cover.

10 ~ 30A

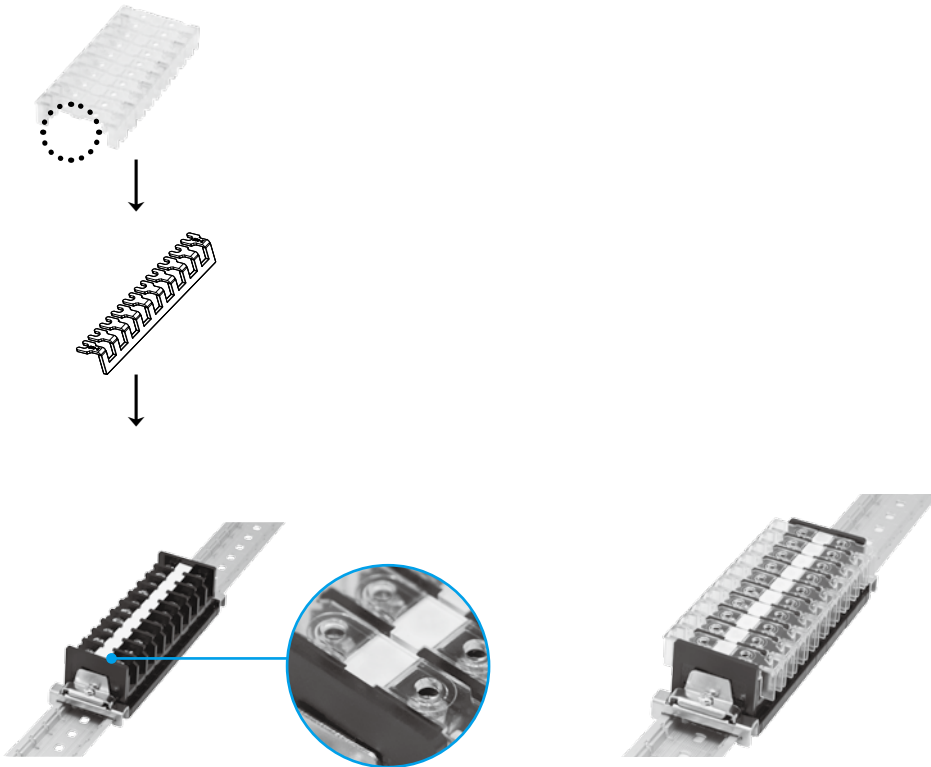

※ caution

Ⓢ Safety Cover

If the number of terminals on the terminal block is different from the number of terminals on the terminal block safety cover, you can use the terminal block safety cover as many as the required number of poles.

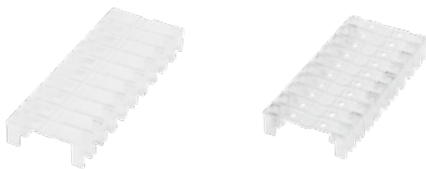

Precautions for assembling the short bar

Be sure to assemble the short bar first, then assemble the terminal protection cover.