

# Temperature Controller

KT Series

## Part Number Description

<b>KT</b>	-	<b>①</b>	<b>②</b>	<b>③</b>	(Economical Type)
<b>① Size</b>	2 : W48 X H96mm	4 : W48 X H48mm	7 : W72 X H72mm		
<b>② Output Type</b>	7 : Relay + Voltage for driving SSR				
<b>③ Communication</b>	0 : No Communication				

## General Specification

<b>Supply Voltage</b>	100 ~ 240VAC 50/60 Hz	
<b>Operation Voltage Range</b>	90% to 110%, rated voltage	
<b>Power Consumption</b>	Max. 5VA	
<b>Indication Method</b>	7-segment 4digits LED : PV in red, SV in green	
<b>Temperature Input</b>	Thermocouple : K,E,J,N,S,T,R,B	Platinum resistance : (RTD) : Pt100
<b>Analog Input</b>	Voltage : 0~20mV, 0~50mV	
<b>Display Accuracy</b>	Normal temperature(23 °C ± 5 °C):(PV ± 0.5% or ± 1 °C, select the higher one) ± 1digit Out of normal temperature range : (PV ± 0.5% or ± 2 °C, select the higher one) ± 1digit	
<b>Control Method</b>	On/Off Control, PID Control	
<b>Control Output</b>	Relay output : 3A/250V AC, Voltage Pulse output (12VDC)	
<b>Sampling Period</b>	250ms	
<b>Vibration Resistance</b>	0.7mm amplitude at 10 ~ 55Hz in each 3 directions for 1.5 hours	
<b>Ambient Temperature</b>	-10 ~ +50 °C (with no icing)	
<b>Storage Temperature</b>	-12 ~ +60 °C (with no icing)	
<b>Ambient Humidity</b>	35 ~ 85%RH (non-condensing)	

## General Function

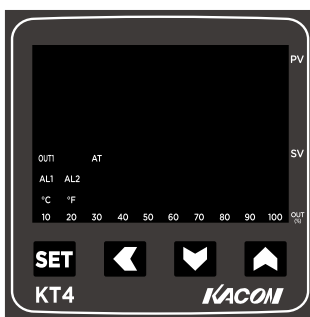

<b>PV</b>	Display : Present value/function display (red)
<b>SV</b>	Display : Set value (green)
<b>OUT1</b>	On when out (green)
<b>AT</b>	flashes when PID auto-tuning (green)
<b>AL1</b>	On when alarm (red)
<b>AL2</b>	
<b>°C , °F</b>	Temperature unit LED (C: Celsius, F:Fahrenheit)
<b>OUT (%)</b>	Output ratio (10 ~ 100%)
<b>SET</b>	Move to parameter, set the parameter value
<b>←</b>	Displaying functions left-shifting the digit
<b>↑</b>	Up and run function
<b>↓</b>	Down and stop function

## Product Selection

Size	Part No.	OUTPUT
4896	KT270	Relay + SSR
4848	KT470	Relay + SSR
7272	KT770	Relay + SSR



## Setting mode 1

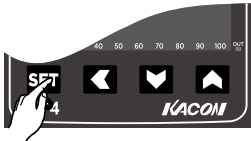

Press **SET** up to 3 sec for parameter group 1 **SET** for adjusted parameter save and pass to next parameter.  
**RT4** key is for return to previous parameter by 3 sec pressing If you press **SET** more than 3 sec for initial display.

Symbol	Name	Range	1#	Description
<b>AT</b>	Autotuning	NO, YES	NO	YES : Autotuning on NO : Autotuning off
<b>AL 1</b>	Alarm 1	-1999~9999	0	Set the alarm value for alarm 1. Alarm differential gap=AH1
<b>AL 2</b>	Alarm 2	-1999~9999	0	Set the alarm value for alarm 2. Alarm differential gap=AH2
<b>SC</b>	PV bias	-199~199	0	Sensor correction is made by adding bias value to measured value(PV).
<b>P</b>	Proportional band	0.0~200.0	20	Proportional band in PID with unit for OUT1 P=0.0, ON/OFF control Please set P1=2.0 when analog input.
<b>HYS</b>	Control Hysteresis	0~999	1.0	Control out differential gap=HYS Only for ON/OFF action when P=0.0
<b>I</b>	Integral tim	0~3600s	210	Set the time of integral action to eliminate the offset occurring in proportional control.
<b>D</b>	Derivative time	0~3600s	30	Set the time of derivative action to improve control stability by preparing for output changes.
<b>CYC</b>	Proportioning Cycle	0~999s	20	Proportioning cycle time for PID control.
<b>RS</b>	Proportional reset	-999~200	-5	Proportional reset for overshoot protection when first power on. (Auto setting after autotuning)
<b>LCK</b>	Set data lock	0~2	0	LCK 0 : Allow to modify any parameter and SV. LCK 1 : SV Only allow to modify SV and AT. LCK 2 : Not allow to modify any parameter and SV.

# Temperature Controller

KT Series

## Setting mode 2



Press the key while pressing the SET key for 3 s to PASS, set PASS=0101, Then press **SET** key to parameter group 2

The following parameter symbols are displayed one by one every time the **SET** key is pressed.

After the value be registered ,when no parameter setting is required, Press the **SET** key for 3s to return the instrument to the normal display.

Symbol	Name	Range	1#	Description
<b>INP 1</b>	Main input type select		K	Temperature sensor table reference
<b>dP</b>	Decimal point	0~3	0	Decimal point creation 0,1 : for TC or RTD or analog type 2,3 : Only for Linear analog type input
<b>LSPL</b>	Low setting	-199~1800	0	Set lower setting limiter, Set high setting limiter
<b>USPL</b>	High setting	-199~2000	400	Lower point of transmission, Higher point of transmission
<b>UNIT</b>	Display scale	C,FA	C	Temperature unit set <b>C</b> : Centigrade <b>F</b> : Fahrenheit <b>A</b> : without scale
<b>PVFL</b>	PV follow-up PV input filter	0~60	55	PV variable-value control, 0-30: for general, 31-60: for enhance
<b>ALM 1</b>	Lowest value of PV display	-199~9999	0	Lowest value display when linear analog inputs, Such as 4-20mA input.
<b>ALH 1</b>	Highest value of PV display	-1999~9999	2000	Highest value display when linear analog inputs, Such as 4-20mA input.
<b>ALd 1</b>	Alarm1 mode	00~16	10	Select the type of alarm 1 See (**ALARM TYPE TABLE)
<b>ALH 1</b>	Alarm1 differential gap	0.0~100.0	0.4	Alarm1 differential gap setting
<b>ALd 2</b>	Alarm2 mode	00~16	10	Select the type of alarm 2 See (**ALARM TYPE TABLE)
<b>ALH 2</b>	Alarm2 differential gap	0.0~100.0	0.4	Alarm2 differential gap setting
<b>OUd</b>	Control action	HEAT, COOL	HEAT	<b>HEAT</b> : Reverse action (Heating) <b>COOL</b> : Direct action (Cooling)
<b>OUT</b>	Control output type		rLy	<b>rLy</b> : Relay drive output <b>SSr</b> : SSR relay drive output
<b>SSr</b>	SSR drive output method		Std	<b>Std</b> : Normal control <b>CYCL</b> : Cycle control <b>PHAS</b> : Phase control
<b>Hz</b>	Power frequency	50, 60	60	<b>50Hz</b> <b>60Hz</b>
<b>LbALt</b>	LBA monitoring time	0~9999 sec	0	Set the alarm time of the Disconnection alarm.
<b>LbARb</b>	LBA monitoring range	0~9999	0	Set the temperature value of the Disconnection alarm.

## Setting mode 3



Symbol	Name	Range	1#	Description
d1-2	RUN / STOP	0 or 1	0	D1-K=0 RUN / STOP Disable D1-K=1 RUN / STOP Enable
rest	Parameter reset	0 or 1	0	rest=1 RUN / STOP Enable

## Password Mode

Press the **SET** button along with the **◀** button, to enter the password mode. Use the **▲▼** buttons to change the numbers, and press the **◀** button to change the cipher numbers.



## Input Sensor Type and Setup

Type '0101' at the password mode to enter the parameter 2 group.

The letters 'INPI' will appear at the PV window, while the letter '---K' at the SV window ('---K' is the initial setup value of the K-type thermocouple).

Use the **▲▼** buttons to select the proper sensor type, and then press the **SET** button to save the setup value.

Sensor Classification	Display Form	Sensor Type	Range (°C)
Thermocouple	℄	K	-15 ~ 1300 °C
	ℰ	E	-15 ~ 600 °C
	℄	J	-15 ~ 800 °C
	℄	N	-15 ~ 1300 °C
	ũ	Wu3-Re25	-15 ~ 2000 °C
	5	S	-15 ~ 1600 °C
	℄	T	-15 ~ 400 °C
	℄	R	-15 ~ 1700 °C
Analog	AN4	-	
	AN3	-	
	AN2	0~50mV	
	AN1	0~20mV	
RTD	P℄	PT100Ω	-199 ~ 800 °C

# Temperature Controller

## KT Series

### Parameter Moving

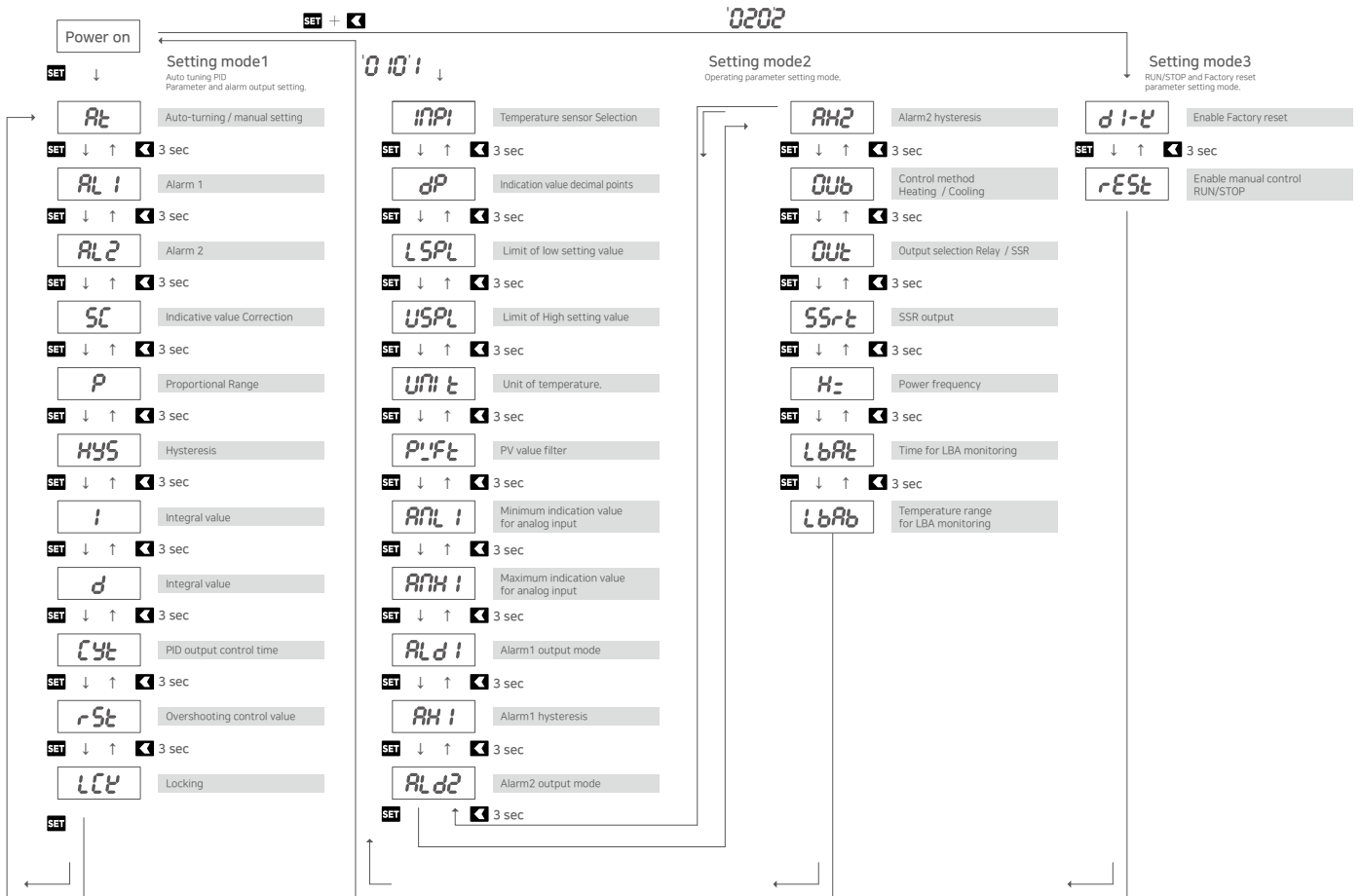

## Dimension

unit : mm

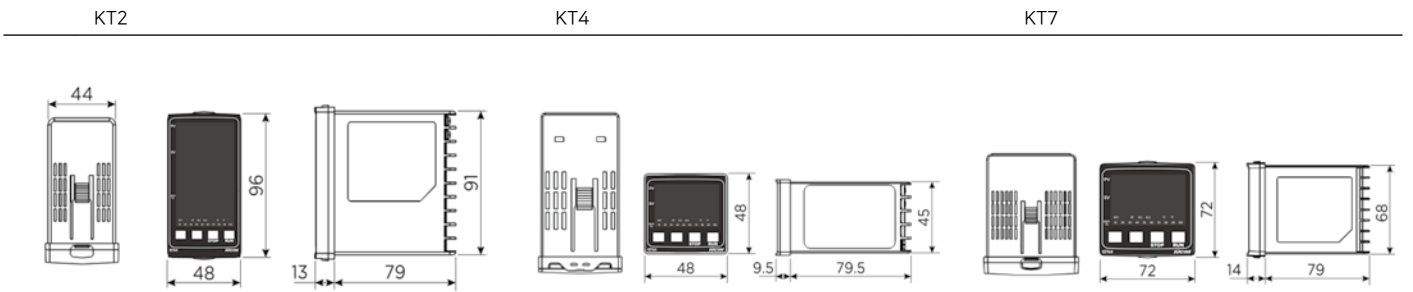

## Diagram

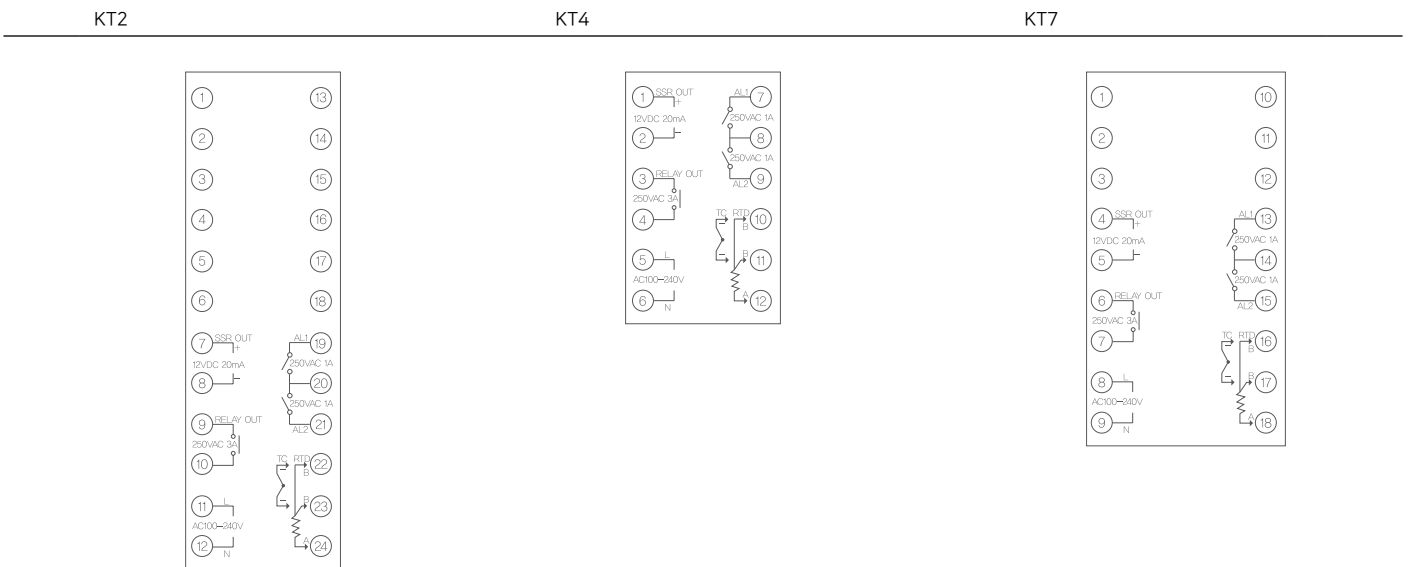

## Mounting

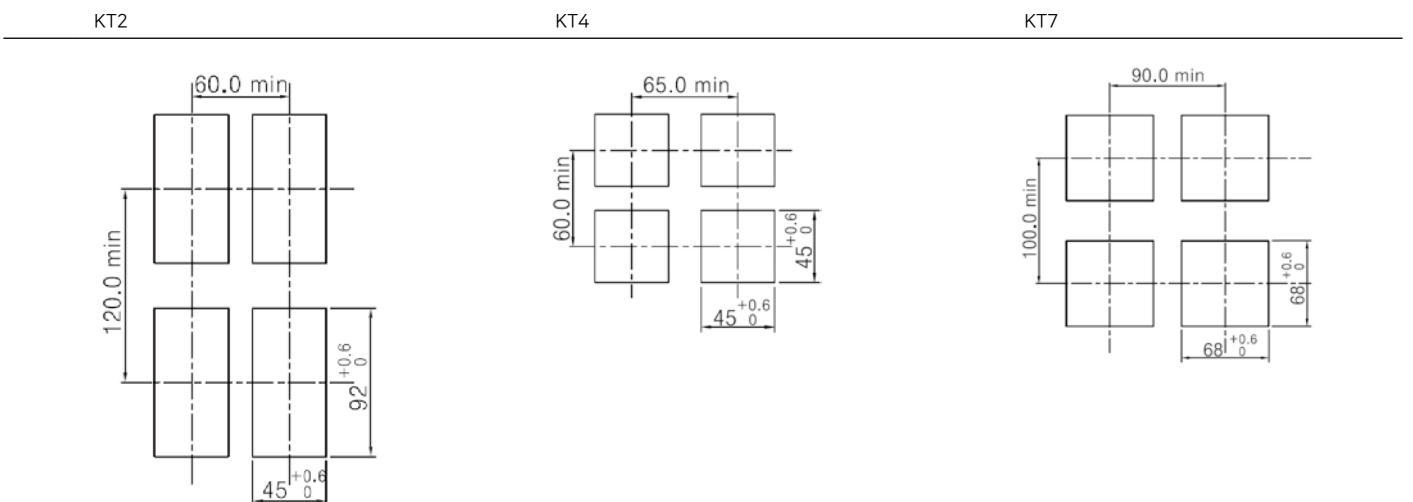

# Temperature Controller

## KT Series

### ■ Main Control Temperature Setup

Press one of the front four buttons for 0.5 seconds, and then release the button. The image will flicker, and the status will change to allow the temperature setup. Use the up and down buttons to select the temperature to control, and then press the **SET** button to save it. If no buttons are pressed for approximately 15 seconds at the temperature setup mode, the temperature will be automatically saved, and the blinking will stop.

### ■ Temperature Correction

Press the **SET** button for more than 3 seconds to enter the parameter group 1. If the letters 'At' appear at the PV, press the **SET** button three times to enter the 'SC' parameter. The 'SC' value is initially set at '0'. Enter the temperature value to be corrected, and press the **SET** button to save it.

For example, if the actual temperature is 50°C, while the PV displays 48°C, replace the value '0' of the 'SC' with '2'. The actual temperature '50°C' will appear at the PV window.

### ■ Heating and Cooling Control

This controller will regulate two temperatures for both heating and cooling. The product is initially set at the heating control. Therefore, go to the parameter group 2, and save either heating (HEAT) or cooling (COOL) at the control direction setup parameter 'DUD'.

### ■ ON/OFF Control Setup

- The ON/OFF control is designed with a simple control output type. The control output is turned on when the setup value is yet to be reached; otherwise, the control output is turned off when the setup value is reached.
- It can be first distinguished in the parameter group 1, wherein the letters 'RL' are first displayed at the PV window from the PID control mode, while the letter 'SC' is first shown at the ON/OFF control.
- Go to the parameter group 1 via the startup screen. The initial value of the control output type is set at the PID control. Therefore, the letters 'RL', which means auto tuning at the PID control mode, will be displayed at the PV window.
- Use the **SET** buttons to select the parameters. The 'P' parameter, which is the proportional value of the PV window, will be displayed with the initial value '20' at the SV window. Replace '20' with '0', and press the **SET** button to save the changed value. The ON/OFF control setup is complete.

### ■ Hysteresis Value Set-up

- In this function, deviations can be applied to the output of the ON/OFF control mode. Once the target control value is reached while in the ON/OFF control, the output may frequently turn on or off to maintain the target value. Deviations can be applied to the output in order to extend the output ON/OFF cycles.
- Go to the parameter group 1, and use the **SET** button to go to the 'HYS' at the PV window. Replace the initial 'HYS' value to '10', and press the **SET** button to save it. The Hysteresis value setup is complete.

### ■ PID Control Set-up

- The PID control takes a longer time to reach the target value, as compared with the ON/OFF control. Nevertheless, it can achieve the exact and precise control at various setup values.
- The factory setting of this product is set at the PID control mode; however, there are instances when it has been changed to the PID control in the ON/OFF control setup.
- While at the parameter group 1, the symbol 'RL' is first displayed at the PV window if the controller is set at the PID control mode, while the first word appears as 'SC' at the ON/OFF control mode.
- Go to the parameter group 1 via the ON/OFF startup screen. Press the **SET** button to change the parameters, so that the proportional value 'P' can be displayed at the PV window. Change the 'P' value with a higher number at the SV window and save it.
- The PID control needs to set parameters consisted of a number of comprehensive equations. Such equations are too difficult to calculate immediately. Therefore, the automatic formula calculation function, which is called the auto tuning, is applied.

### ■ Filtering the Current Temperature Input Value

- Rapid changes in the temperature value may trigger frequent changes to the PV display value.
  - Such will affect the control operation volume, and make it difficult to achieve a stable control.
- However, the display value of the current temperature can be stabilized by applying the current temperature filter 'PFL' in the parameter group 1.
- Increase the filter value to slow down the changing speed of the input display value, and to steadily display the current value.

### ■ Proportional Value Reset

- If the proportional values are applied to the temperature control (PID/P), a certain deviation may occur even when control has been stabilized depending on the heater capacity and/or the space area.
- The proportional value reset 'rSL' function in the parameter group 1 enables the correction of the steady-state deviation (OFFSET).
- For an automatic setup, execute the auto tuning 'RL' at the PID control mode.

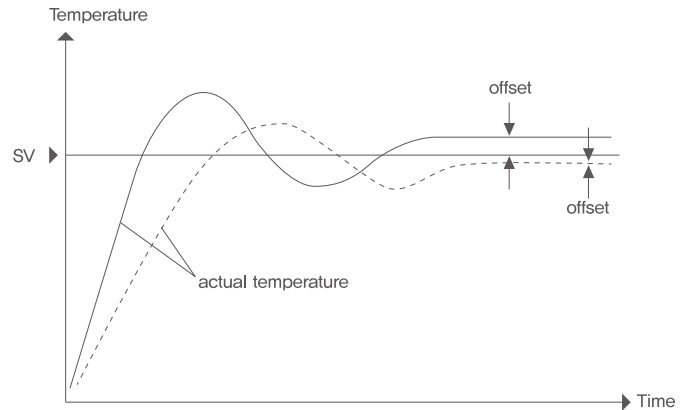

OFFSET: It normally means a dislocation or deviation. In temperature control, the term refers to the degree of difference between the setup value (SV) at a state where the operation value is stabilized, and the current controlled temperature value (PV).

### ■ Auto Tuning

- This function automatically sets the proportional (P), integral (I), and differential (D) values at the PID control mode.
- After selecting the PID mode in the control setting of the product, go to the parameter group 1, and check if the letters 'RL' appear at the PV window, and 'RD' at the SV window, respectively. Use the direction buttons to change from 'RD' to 'YES', and save it by pressing the **SET** button. The auto tuning will start to repeat a number of over and under shooting around the target value to complete the process.
- The progress of the auto tuning can be checked through the blinking of the 'RL' lamp at the display window.

### ■ Relay and SSR Outputs

- The KACON Temperature Controller KT Series is built in with the relay output and the SSR output contacts.
- The parameter setup helps facilitate changes to the main output method.
- Go to the parameter group 2, select the relay 'rLY' or the SSR 'SSr', and save it as 'OUT' at the output method setup parameter.
- In the case of 'SSR', the output methods consisted of three methods, which can be selected by the user depending on the control situation.

■ SSR Output Method

- Select the output method of the controller with SSR to activate the SSR output type parameter 'SSRn' in the parameter group 2.
- The SSR output type has a total of three kinds, which can be selected by the user depending on the situation.

① Normal Control (Standard)

This function operates in the same way as the normal relay output in accordance with the ON/OFF or the PID controls.

② Cycle Control (CCL)

This function controls the output volume by adjusting the output numbers during a certain cycle, and the temperature will repeatedly flicker ON/OFF according to the output ratio. The output ratio can be observed through the (%) display lamp. The blinking number decreases when the current value approaches the target value, while the blinking number increases as the current value gets far from the target value. Depending on the case, if the output ratio becomes higher than the reference point, the OUT lamp will continuously flicker.

③ Status Control (PHAS)

This function controls the status within a half cycle of the AC power source, and produces a similar effect when using a power controller. However, such function is operative at a random cross SSR only.

Example for Circuit configuration of SSR output

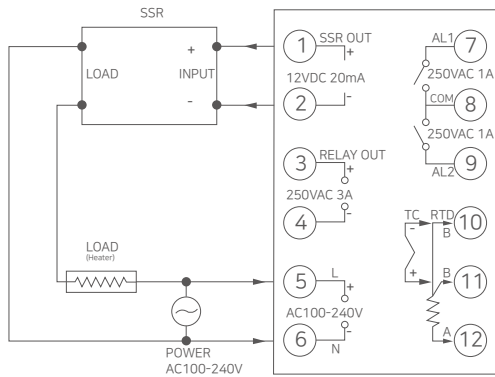

- SSR is set to single-phase, Also applicable to three-phase SSR
- Examples of how to control the heat control for convenience heard.

Example for Circuit configuration of Relay output

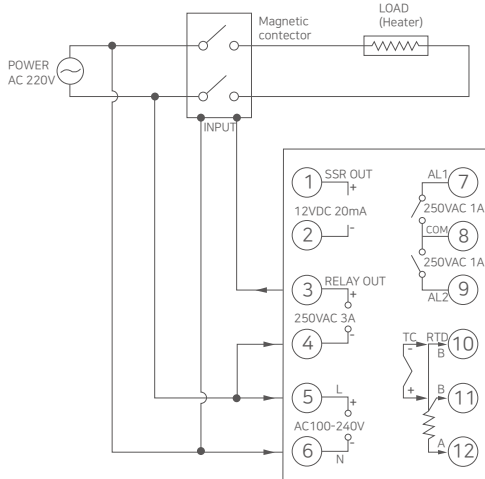

- Set the main power supply is AC220V and example output of the magnetic contact or heard.
- Examples of how to control the heat control for convenience heard.

■ Alarm mode specification

Operation Type	Set Value	Alarm Type	Specification (Example for alarm 1)
	10 or 00	No alarm	
Normal Action	11	High limit Alarm	$AL \geq 0$ :
			$AL < 0$ :
	12	Low limit Alarm	$AL \geq 0$ :
			$AL < 0$ :
	13	High-low limit Alarm	
	14	Band alarm	
Holding Action	01	High limit Alarm	$AL \geq 0$ :
			$AL < 0$ :
	02	Low limit Alarm	$AL \geq 0$ :
			$AL < 0$ :
	03	High-low limit Alarm	
	04	Band alarm	
	05	Absolute high alarm	
	06	Absolute low alarm	
	09	Break loop alarm	

※ Example of the output of the holding operation

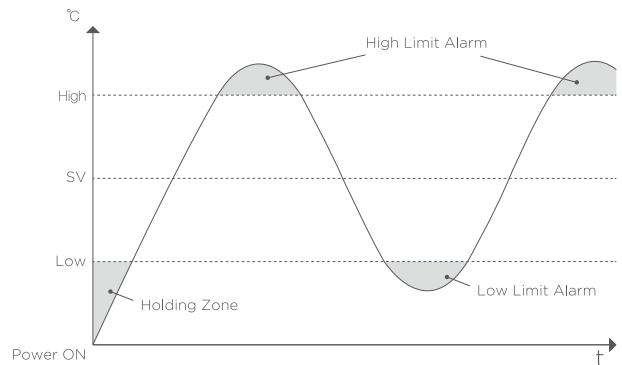

\* With holding action : When holding action is ON, the alarm action is suppressed at start-up until the measured value enters the non-alarm range



# Temperature Controller

## KT Series

### Alarm (Warning) Set-up

- The output, which can be used as a supplement output other than the main output that controls the temperature, is called an alarm output or warning output.
- This product consisted of two alarm-relay contacts. Refer to the alarm setup table to produce various types of alarms.
- Go to the parameter group 2 to select the alarm setup 1 parameter (AL d 1) at the PV window.
- The product is initially set to show the value '0' at the SV window, which suggests that there is no alarm. Refer to the alarm setup table to enter the function code to be used, and press the **SET** button to save it.
- The alarm 2 setup can be established in the same method as the alarm 1. This can be achieved by selecting the alarm 2 parameter (AL d 2).
- Once the alarm function is set, the reference value for the output (i.e. the alarm setup value) is required. This setup value determines the time when the output occurs, and may differ depending on the alarms with the deviation value or the absolute value.
- Go to the parameter group 1, select either AL1 or AL2 at the PW window, enter the appropriate setup value, and save it.
- Deviation value : This means that the value, as well as the deviated temperature, is based on the main setup temperature value. If the main setup temperature value changes, the value will automatically change the alarm output time accordingly.  
Example) Main setup temperature : 100°C  
Upper deviation limit of the deviated alarm value : 5°C  
Output time : 105°C
- Absolute value : The alarm setup value itself that matches the value at the output time regardless of the main setup temperature value. If the current temperature value matches the setup value, the alarm output will occur.  
Such values of the alarm output time will not change even though the main setup temperature values have changed.

### Alarm for Heater disconnection

- This function determines the heater disconnections depending on the temperature changes during setup.
  - While the main control output runs 100%, an alarm signal will sound when it considers that the heater is abnormally connected, as there are no changes made with the setup temperature (LbAb) during the setup time (LbAt).
- For example, if the LbAt is set at 100 seconds, while the LbAb is set at 10°C, an alarm signal will go off due to slight changes made to the temperature that are not exceeding 10°C.

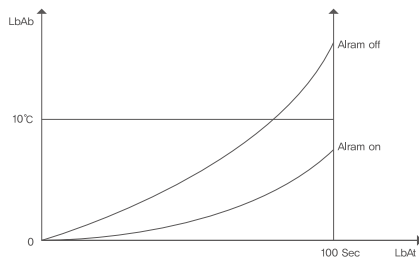

### Factory reset

- This function initializes the controller. It is useful for cases when unable to pinpoint which parameters were changed. Use this function to initialize all parameters, and to restart from the beginning.
- Go to the password mode. Press the **SET** button with the symbol '0000' to revert changes made to the parameter group 3. The letters 'd 1-2' will appear at the PV window. Press the **SET** button once more, and 'rE5t' will be displayed at the 'PV' window. Change '0' to '1' at the 'SV' window in order to activate the initialization function. Once the initialization function is activated, go to the startup screen and press the **SET** buttons at the same time for more than three seconds until the screen has changed several times, and then the parameters are initialized.
- The parameters can be initialized only when the setup value of the 'rE5t' of the parameter group 2 is at '1'. Such initialization will not be possible while the value is set at '0'.

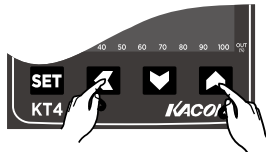

### Manual control (Run/stop)

- Enter '0000' using the buttons at the password mode. Press the **SET** button to go to the parameter group 3. The letters 'd 1-2' will be shown at the 'PV' window and '0' at the 'SV' window, respectively.
- To activate the RUN/STOP function, change the 'SV' value '0' to '1', and then press the **SET** button to change the setup value.
- Once the function is activated, return to the startup screen, and then press the **SET** button for more than 3 seconds to set the function-stop.
- To relieve the function-stop, press the **SET** button for more than 3 seconds.
- When the symbol 'd 1-2' is changed to '1', the conversion between 'RUN/STOP' function will be performed. However, if 'd 1-2' is changed to '0', the conversion between 'RUN/STOP' will not be performed.

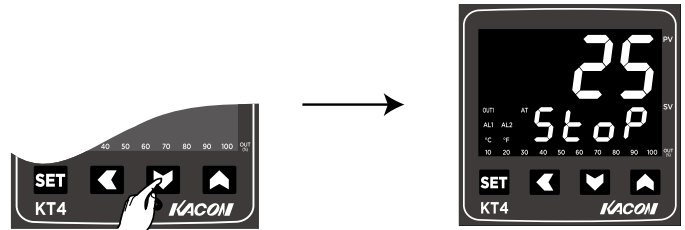

### Error display

- OHMO** : This function indicates that the temperature sensors are not properly connected.
- OLLO** : This function indicates that the temperature sensors are connected; however, its temperature sensor setup is inaccurate. (Example: The case in which the thermo-coupler is actually connected, and the temperature sensor is set at 'PT'.)

### Applied Terminals

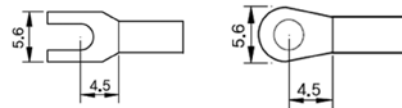

### Installation Method

